

CAT 4660

Parflex Thermoplastic & Fluoropolymer Products
Hose, Tubing, & Fittings 2020



ENGINEERING YOUR SUCCESS.

Extra care is taken in the preparation of this literature but Parker is not responsible for any inadvertent typographical errors or omissions. Information subject to change without notice. The information in this catalog is only accurate as of the date of publication. For a more current information base, please consult the Parflex® Division web site at www.parker.com/pfd.



FAILURE OR IMPROPER SELECTION OR IMPROPER USE OF THE PRODUCTS AND/OR SYSTEMS
DESCRIBED HEREIN OR RELATED ITEMS CAN CAUSE DEATH, PERSONAL INJURY AND PROPERTY DAMAGE.

This document and other information from Parker Hannifin Corporation, its subsidiaries and authorized distributors provide product and/or system options for further investigation by users having technical expertise. It is important that you analyze all aspects of your application and review the information concerning the product or system in the current product catalog. Due to the variety of operating conditions and applications for these products or systems, the user, through its own analysis and testing, is solely responsible for making the final selection of the products and systems and assuring that all performance, safety and warning requirements of the application are met.

The products described herein, including without limitation, product features, specifications, designs, availability and pricing, are subject to change by Parker Hannifin Corporation and its subsidiaries at any time without notice.

Offer of Sale

The items described in this document are hereby offered for sale by Parker Hannifin Corporation, its subsidiaries or its authorized distributors. This offer and its acceptance are governed by the provisions stated in the "Offer of Sale".



**Parflex is
known globally
for innovation,
leadership and
problem solving.**

Welcome to Parflex

Hose

Thermoplastic
Fluoropolymer

Tubing

Thermoplastic
Fluoropolymer

Coils

Thermoplastic
Fluoropolymer

Heat Shrink

Fluoropolymer

Fittings

Permanent Crimp
Field Attachable

Table of Contents

A Hose

Intro

Introduction.....1

B Tubing
Thermoplastic

Hose A

Table of ContentsA-2
 Visual IndexA-4
 Introduction/Technical DataA-7
 ThermoplasticA-32
 FluoropolymerA-69

NOMENCLATURE

Thermoplastic Hose.....A-29
 PTFE Hose.....A-30

C Coiled Air Hose
& Fittings

Tubing B

Table of ContentsB-2
 Introduction/Technical DataB-4
 Thermoplastic.....B-20
 FluoropolymerB-44

TECHNICAL

Tubing Specifications.....B-6
 Tubing Pressures.....B-7
 Tubing - Materials OverviewB-4
 Tubing Compatibility Chart-FittingsB-8
 Tubing - Materials CompatibilityB-10

D Transportation

Coiled Air Hose C

Table of ContentsC-2
 Introduction/Technical DataC-3
 Fast-Stor® Air Hose.....C-4
 Fluoropolymer Air HoseC-8

E Fittings

TECHNICAL

Agency SpecificationsA-7
 PTFE Hose Chemical ResistanceA-8
 Hose ConstructionA-9
 Construction Specifications.....A-10
 Selection of Hose DiameterA-18
 Calculation of Hose LengthA-19
 Hose Material FeaturesA-20
 Hose Material OverviewA-21
 Compatibility Guide Media/Hose Mat'l.....A-22
 Volumetric Expansion of Hose.....A-26
 Selection, Installation, Maintenance.....A-27

F Tooling,
Equipment
& Accessories

NOMENCLATURE

Nylon TubingB-14
 Polyurethane TubingB-14
 Polyethylene Tubing.....B-15
 Polypropylene Tubing.....B-15
 Vinyl Tubing.....B-15
 Fluoropolymer Tubing.....B-16
 Convoluted TubingB-17
 Corrugated TubingB-17
 Heat Shrink TubingB-18
 PTFE BeadingB-19
 Spiral Wrap TubingB-19

G General
Technical

Transportation D

Table of ContentsD-2
 Introduction/Technical DataD-3
 Tubing.....D-5
 DEF HoseD-12



Table of Contents

Fittings E

Table of Contents E-3
 Field Attachable E-22
 Permanent Crimp E-33

NOMENCLATURE

Field Attachable/Permanent Crimp.....E-4

TECHNICAL

Fitting Configurations E-5
 Sanitary Sizing (PAGE Series) E-6
 Pressure Rating-Hose End Connections..... E-8
 Hose Fitting Insertion Values E-10
 Identifying Fitting Types..... E-11
 Determining Thread Type E-12
 German DIN Hose Fittings..... E-13
 British Standard Pipe..... E-14
 North American Thread Types E-15
 Japanese Fittings..... E-17
 Fitting Thread Guide for Hose E-18
 Media to Fitting E-20
 Metals Corrosion Scale..... E-21

Tooling F

Table of Contents F-2
 Crimpers F-4
 Swager/Mender F-14
 Accessories F-15

General Technical G

Table of ContentsG-2

CRIMP INSTRUCTIONS

Permanent CrimpG-4
 Series 54, 56, CG, 92, CY, MS, SF
 Field Attachable..... G-8
 Series 51, 51R, BU, MS
 PTFE Permanent CrimpG-9
 Series 91, 91N, 93N
 PTFE Permanent CrimpG-11
 Series PAGE
 PTFE Field AttachableG-13
 Series 90
 Sewer Hose SwagingG-15
 Twin/Multi-Line Separation.....G-17

SAFETY / WARRANTIES

Parker Safety GuideG-19
 Enerpac WarrantyG-23
 Offer of SaleG-24

INDEX

By part numberG-26
 By keyword.....G-29



A Hose

B Tubing
Thermoplastic

C Coiled Air Hose
& Fittings

D Transportation

E Fittings

F Tooling,
Equipment
& Accessories

G General
Technical

Parflex®

Partner. Innovator. Leader.

Parflex is a global leader in hose and tubing solutions for extreme applications.



Our Global Footprint

As part of the Parker Fluid Connectors Group, the Parflex Division is responsible for the design and manufacture of hoses and tubing to handle extreme applications. Products include thermoplastic and fluoropolymer hose and tubing, hose bundles, harnesses and accessories.

The Parflex Division includes the Ravenna, OH headquarters and manufacturing facilities in:

- Manitowoc, WI
- Fort Worth, TX
- Mansfield, TX
- Stafford, TX
- Randleman, NC
- Monterrey, Mexico
- Huttenfeld, Lampertheim, Germany
- sister division, ***polyflex***

Tap Into Our Resources

In our state-of-the-art Polymer Innovation Center, driven by the single purpose of finding solutions to your most demanding fluid connector requirements. Abrasion, chemical compatibility, purity and permeation are just a few of the challenges our engineers work on everyday.

The Polymer Innovation Center is your portal to an array of solution-driven abilities and assets, all conveniently situated within a single organization.



What's New

The biggest change to the catalog is in structure.

Now each chapter also includes the technical data for those products. For example, the General Technical section hose charts have been moved to Hose, tubing charts to Tubing and fitting charts to Fittings. Also, in the Fitting section, fittings are broken up into a Field Attachable section and a Crimp section.

And, like always, the product information was updated where applicable.

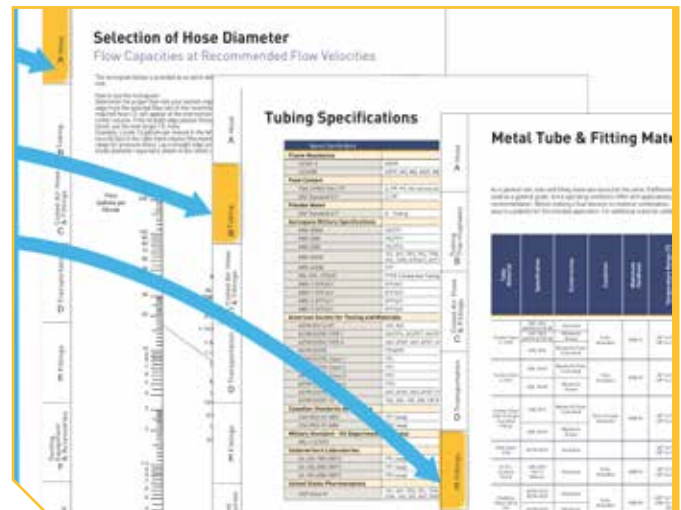

What's Different With A Parflex Hose

For one thing, the reputation that precedes it.

Our reputation for being a problem solver in extreme hose applications can be traced to our ability to partner with our customers and become an extension of their engineering department rather than just another supplier.



For another thing, Parflex hoses are:

- more compact without reducing flow
- more flexible without compromising strength
- lighter without diminishing performance
- and can handle a very wide range of temperatures and working pressures

Hose

Hose & Fittings Highlights

- Parflex thermoplastic hoses are lightweight with weights up to 70% lighter than competitive constructions. Thermoplastic constructions also offer a compact O.D. (30%-70% smaller) and a low length change under pressure (as low as +/- 1%).
- Rapid Assembly fittings are available to improve installation time with hoses up to 3000 psi that are qualified with 56-series fittings such as 53DM and 518D.
- TOUGHJACKET (TJ) hoses deliver 650x more abrasion resistance than standard rubber equivalents. After 143 hours of testing, the TJ hose jacket was still intact. Unfortunately, the competitive hose didn't fair as well. The internal wire reinforcements were breaking through.
- Our low temperature hoses operate in temperatures as low as -70°F/-57°C (depending on series) with no embrittlement or added stress to the core tube.



Advantages of Formed & Bonded Hoses -Why They Contribute to Your Bottom Line



- Cleaner Routings, decreasing maintenance time
- Weight reduction compared to conventional rubber and steel lines
- Reduced labor cost through quick and easy install
- Rigid but flexible, eliminating misalignment issues of steel tube equivalent
- Minimized leak points by eliminating thread joints and hose-tube combinations
- Reduced abrasion issues, increasing hose life compared to conventional rubber hose
- Reduced inventory components by eliminating clamps and/or single assemblies



Thermoplastic Hose Advantages

Parker Parflex offers an extensive selection of high-quality thermoplastic and fluoropolymer hose and tubing, fittings and accessory solutions for “extreme” applications. We specialize in designing products to meet specific needs for increased profitability and efficiency.

Long Lengths

- In some product lines, continuous lengths up to 3,500 meters (11,484 feet) are available.



Bonded Hose

- Parflex bonded assemblies help prevent hose-to-hose abrasion at high stress levels. Bonding 2 to 10 varying-sized hoses (maximum 6" (152 mm) wide) together, bonded assemblies keep hoses from rubbing against each other or tangling.



Smaller I.D.

- The Parflex manufacturing process does not require a mandrel for support of the core tube so hoses can be made to a smaller inner diameter such as 1.3 mm (.051 inch).

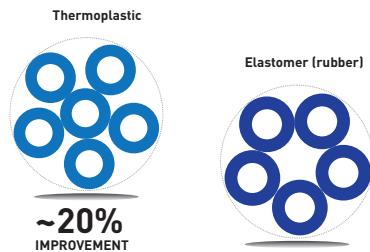

Compact O.D.

- Compact designs allow for a tighter bend radius, allowing the hose to be used in smaller work envelopes and facilitate quicker installs (up to 50%).

Size	Typical 100R17 Hose (rubber) inch / mm	D6R Hose inch / mm	Space Benefit
-4	0.52 13.2	0.46 11.7	11%
-6	0.67 17.0	0.61 15.5	9%
-8	0.81 20.6	0.76 19.3	7%
-10	0.98 24.8	0.96 24.4	2%
-12	1.15 29.2	1.15 29.2	0%
-16	1.47 37.3	1.44 36.5	2%

Abrasion Resistance

- In our new Polymer Innovation Center, Parflex engineers blend resins and create patented designed hoses to reduce permeation and withstand hours of abrasion without damaging the hose.

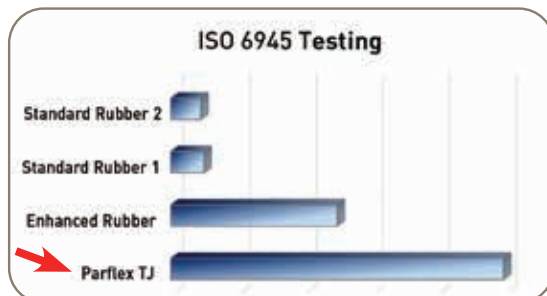

Lightweight

- Parflex products are lighter in weight due to their fiber reinforcements. In fact, a Parflex hose can weigh more than 70% less than a comparable rubber hose assembly.

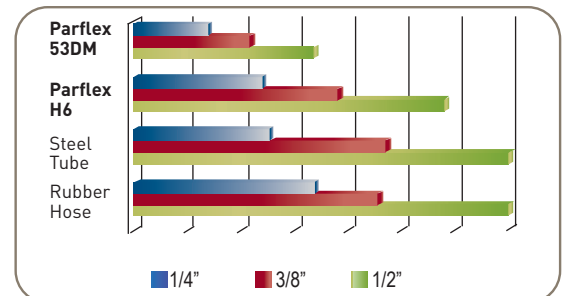

Fluoropolymer Hose Advantages

Parker Parflex manufactures PTFE hose for most markets that require high temperatures, chemical resistant hoses, or have applications where lubricity plays a critical factor in the success of the operation. Increased lubricity facilitates flow and makes for easy cleaning.

Chemical Compatibility

- The chemical compatibility of fluoropolymers is far greater than conventional thermoplastics or rubber products.

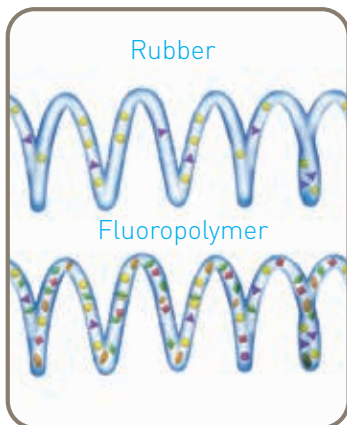

High/Low Temperatures

- PTFE products boast an operating temperature range of -100°F (-73°C) to 500°F (260°C). For FEP and PFA, view specific materials for actual operating temperatures.

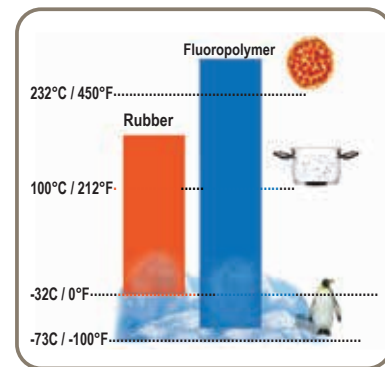

- In cold or heat, Fluoropolymers provide improved performance to flexing, vibration and impulse. Customers who make the switch not only reduce unscheduled maintenance repairs, but often, warranty repairs as well.

Shelf Life

- Under optimal storage conditions, fluoropolymer and thermoplastic hose and tubing products should have unlimited storage life prior to initial usage.*

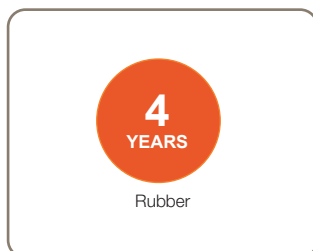

Eliminate Drive Time With The Best Portable Crimper On the Market



Grab & Go

Create factory style assemblies in minutes.

Ready to go at a moments notice.

With no additional power source required for operation and a built in carry handle, the MiniKrimp® is easy to transport to remote locations.

- Weight: 45 lbs. or less
- Force: 30,000 tons @ 10,000 psi max
- Cycle time: Approximately 30 seconds

Speed Up Installations with Rapid Assembly Wrenchless Fittings

No Tools Necessary

Speed Up Hose Installation by 50%



56 Series

With one adapter, speed up assembly installations by 50%. Simply screw in the adapter and push the tube stub fitting into the adapter.

- Available for hoses qualified with 56-series fittings and pressures up to 3000 psi
- Typical Applications
 - Pilot lines
 - Joystick
 - Skid steer chassis

Reduce costs without reducing performance.

[Watch the Video](#)



[Watch the Video](#)

51R Series

The 51R-series is the newest generation of Parflex field attachable fittings. With assembly possible via a deep well socket or screw gun and a vise, field repair and/or assembly has never been quicker.

- Available for 510D and 518D hoses (-3, -4, -6 and -8)
- Typical Applications
 - Hydraulic lines
 - Aerial lift
 - Car carrier

Parflex Manufactures Tubing for Almost Every Application

Not only is the tubing selection complete, so are the options to improve installation times. Parflex offers cut pieces, assemblies, bundled tubing, formed tubing, and combinations of all options.



Thermoplastic & Fluoropolymer Tubing

- Air Brake
- Flame Resistant
- Diesel Fuel
- Nylon
- Polypropylene
- Polyurethane
- Polyethylene
- PVC
- Retractable Coils
- PTFE
- FEP
- PFA/High Purity PFA
- Beading
- Electrical Insulation
- Convoluted
- Corrugated
- Spiral Wrap
- Heat Shrink



Tubing Highlights



Airbrake Tubing

- Every year, Parflex makes enough airbrake tubing to circle the globe.
- Available in made to length harnesses for quicker installations.
- Excellent UV stability
- Meets SAE Specification J844
- Most sizes meet DOT FMVSS 49CFR 571.106

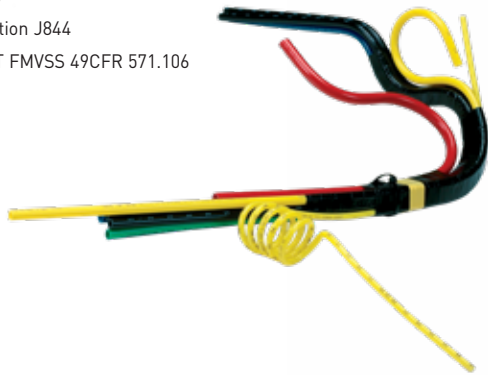

Heat Shrinkable Tubing

- PTFE Shrink - 2:1, 4:1
- FEP Shrink - 1.3/1, 1.67/1
- FEP Roll Cover - 1.25/1
- FDA compliant
- USP Class VI compliant



Flame Resistant Tubing

- Extremely flexible tubing with a flame resistant jacket to protect the core tube from weld spatter and harsh environment applications. The specially formulated jacket material is easy to skive, exposing the core tube for quick insertion into Parker's Prestolok PLM fittings.
- Use with Parflex Skive Tool for easy skiving.
- UL-94 V0 compliant jacket





Parflex

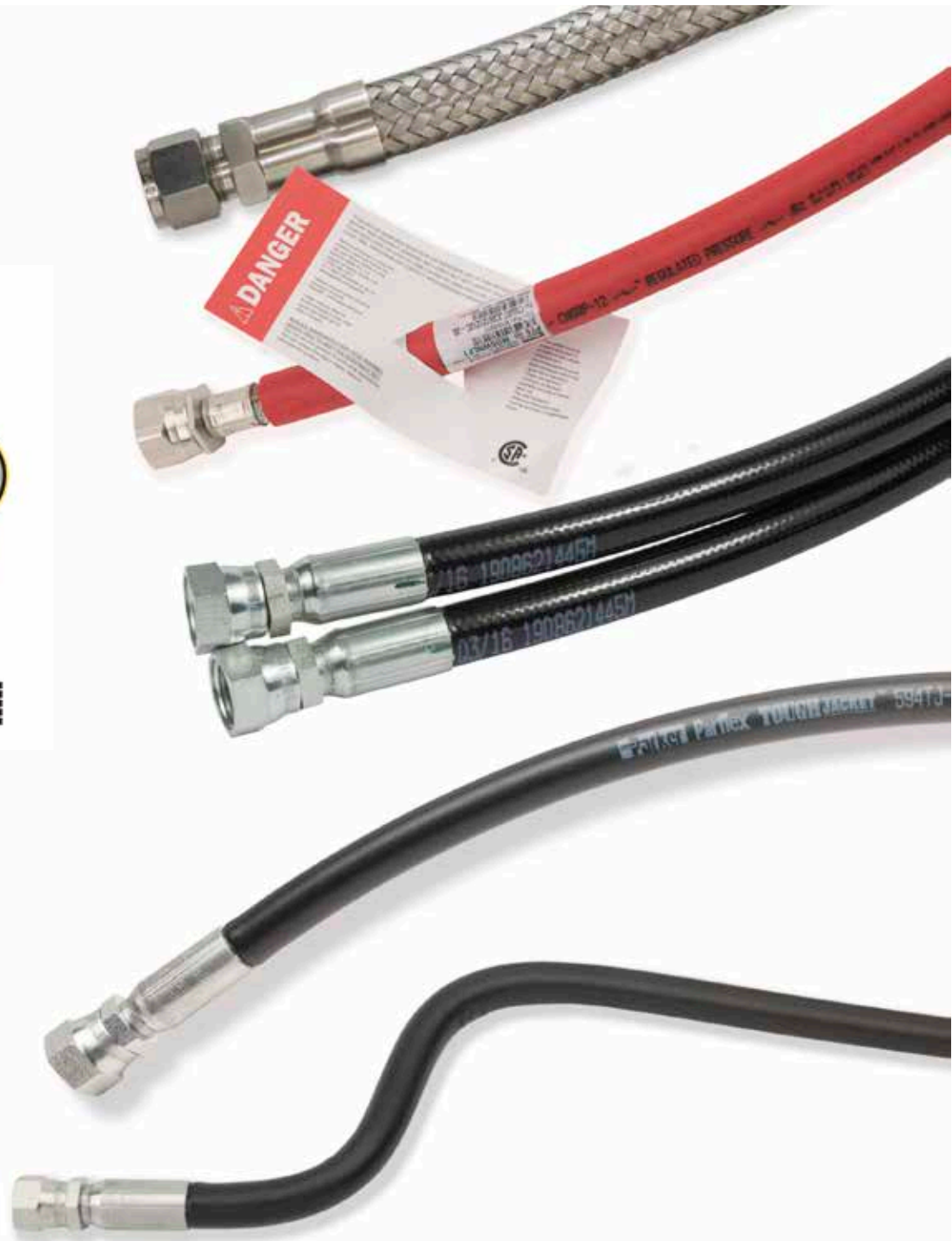

Hose

Thermoplastic

Fluoropolymer

Table of Contents



Parflex

HOSE

Hose Index.....	A-4
Thermoplastic - Fiber Reinforced.....	A-4
Thermoplastic - Wire Reinforced & Non-Conductive.....	A-5
Fluoropolymer (PTFE).....	A-6

TECHNICAL DATA

Agency Specifications.....	A-7
PTFE Hose Chemical Resistance.....	A-8
Hose Constructions.....	A-9
Construction/Specs, Thermoplastic Hose psi	A-10
Construction/Specs, Thermoplastic Hose MPa.....	A-14
Construction/Specs, PTFE Hose psi.....	A-12
Construction/Specs, PTFE Hose psi MPa.....	A-16
Selection of Hose Diameter.....	A-18
Calculation of Hose Length	A-19
Selecting the Correct Hose, "Stamped".....	A-19
Hose Material Features.....	A-20
Hose Material Overview.....	A-21
Compatibility Guide Media/Hose Material.....	A-22
Volumetric Expansion of Hose.....	A-26
Selection, Installation Maintenance.....	A-27

NOMENCLATURE

Nomenclature, Thermoplastic Hose.....	A-29
Nomenclature, Parflex PTFE Hose	A-30
Nomenclature, "PAGE" PTFE Hose	A-31

Designing "problem-solving hoses"
is what we do best
and that's why
it's hard to match
the cost saving value
of a Parflex hose.



A
Hose

B
Tubing

C
Coiled Air Hose
& Fittings

D
Transportation

M
Fittings

T
Tooling,
Equipment
& Accessories

G
General
Technical









Hose Index

Thermoplastic - Fiber Reinforced



Fiber Reinforced Thermoplastic Hose

Part No.	Description	Pg.
 510C	General Hydraulic <i>Pending obsolescence see 510D/518D</i>	A-43
 510D	General Hydraulic	A-44
 520N	General Hydraulic	A-47
 527BA	Breathing Air Refill 7,000 psi	A-48
 53DM	53DM - Low Temp 	A-51
 540N	General Hydraulic <i>Pending obsolescence see 510D/518D</i>	A-49
 540P	Specialty Water	A-50
 55LT	Low Temperature 	A-52
 56DH	Diagnostic	A-53
 575X/ 575XN	Fast Response 5,000 psi	A-54
 580N	High Pressure	A-55

Fiber Reinforced Thermoplastic Hose

Part No.	Description	Pg.
 1035HT	High Temperature Power Cleaning	A-57
 B9	General Purpose	A-58
 HLB/ HLBD	Lubrication	A-62
 MSH	Marine Steering	A-63
 MSXL	Marine Steering, High Pressure	A-64
 PTH	Marine Power Tilt	A-65
 S5N	Predator® Water Jetting 4,000 psi	A-66
 S6	Predator® Water Jetting 2,500 psi	A-67
 S9	Predator® Water Jetting 3,000 psi	A-68

Fiber Reinforced Conductive Natural Gas Thermoplastic Hose

Part No.	Description	Pg.
 5CNG	Compressed Natural Gas Electrically Conductive	A-59
 8LPG	LPG / Compressed Natural Gas, Electrically Conductive	A-61

Tubing

Coiled Air Hose & Fittings

Transportation

Fittings

Tooling, Equipment & Accessories

General Technical

Hose Index

Thermoplastic - Wire Reinforced & Non Conductive

Wire Reinforced Thermoplastic Hose

Part No.	Description	Pg.
 563LT	Low Temperature Hydraulic 3000 psi Constant Pressure	 A-40
 560TJ	TOUGHJACKET™ General Hydraulic	 A-38
 563TJ	TOUGHJACKET™ 3000 psi Constant Pressure	 A-39
 590TJ	TOUGHJACKET™ General Hydraulic	 A-41
 594TJ	TOUGHJACKET™ 4000 psi Constant Pressure	 A-42

Wire Reinforced Thermoplastic Hose

Part No.	Description	Pg.
 D6R/ D6RX	3000 psi Constant Pressure	A-32
 H6	Hydraulic Hose, Constant Pressure 3,000 psi	 A-35
 HFSR	Hybrid® Hose with Rubber Cover	A-33
 HFS2R	Hybrid® Hose with Rubber Cover, 2 braids	A-34
 HTB/ HTBR	Eliminator® Compact	A-37
 R6	3000 psi Constant Pressure	 A-36

Wire Reinforced Conductive Natural Gas Thermoplastic Hose

Part No.	Description	Pg.
 CNGRP	Regulated Pressure CNG Electrically Conductive	A-60

Non-Conductive Thermoplastic Hose

Part No.	Description	Pg.
 518C	Hydraulic Non Conductive <i>Pending obsolescence see 510D/518D</i>	A-45
 518D	Hydraulic Non Conductive	A-46
 528N	General Hydraulic Non-Conductive	A-47
 538DM	DuraMax Low Temp Non-Conductive	 A-51
 588N	High Pressure Non-Conductive	A-55
 83FR	General Purpose Non-Conductive	A-56

A
Hose

B
Tubing

C
Coiled Air Hose & Fittings

D
Transportation

E
Fittings

F
Tooling, Equipment & Accessories

G
General Technical





Hose Index

Fluoropolymer



900 Series Fluoroplastic Hose

Part No.	Description	Pg.
 919 919B	PTFE Natural Core/ Static Dissipative Core	A-69
 919J 919BJ	Silicone Jacketed PTFE Static Dissipative Core	A-70
 919U	Silicone Jacketed PTFE Natural Core	A-71
 929 929B	Heavy Wall PTFE Natural / Static Dissipative Core	A-72
 929BJ	Silicone Covered Heavy Wall PTFE Static Dissipative Core	A-73
 939 939B	Convuluted PTFE Natural/ Static Dissipative Core	A-74
 944B	High Pressure PTFE Static Dissipative, up to 4,500 psi	A-75
 955B	High Pressure PTFE Static Dissipative Core, 5,000 psi	A-76

PAGE Fluoroplastic Hose

Part No.	Description	Pg.
 STW STB	PTFE Natural / Static Dissipative Core	A-77
 SCW SCB	Convuluted PTFE Natural/ Static Dissipative Core	A-78
 SCWV SCBV	Heavy Wall Convuluted PTFE Natural /Static Dissipative Core	A-79
 PCW PCB	Polypropylene Braid Convuluted PTFE Natural /Static Dissipative Core	A-80
 NCW NCB	Nomex Braid Convuluted PTFE Natural /Static Dissipative Core	A-81

Other Hoses

Part No.	Description	Pg.
 METAL	Metal Hose	A-82
 MLT	Multitube Hose	A-83
 UHP	polyflex Ultra High Pressure Hose	A-84

Static Dissipative Fluoroplastic Hose

Part No.	Description	Pg.
 919B STB	PTFE Static Dissipative	A-69 A-77
 919BJ	Silicone Jacketed PTFE Static Dissipative	A-70
 929B	Heavy Wall PTFE Static Dissipative	A-72
 929BJ	Silicone Covered Heavy Wall PTFE Static Dissipative	A-73
 939B SCB	Convuluted PTFE Static Dissipative	A-74 A-78
 944B	High Pressure PTFE Static Dissipative, up to 4,500 psi	A-75
 955B	5000 psi High Pressure PTFE Static Dissipative	A-76
 NCB	Nomex Braid Convuluted PTFE Static Dissipative	A-81
 PCB	Polypropylene Braid Convuluted PTFE Static Dissipative	A-80
 SCBV	Heavy Wall Convuluted PTFE Static Dissipative	A-79

Agency Specifications

Agency Specifications	Hose Series
Flame Resistance	
MSHA	D6R, HFS2R, HLB, HLBD, HTB, HTBR, 560TJ, 563TJ, 590TJ, 594TJ, 520N, 540N, 56DH-2, 575X, 580N, 83FR
UL94HB	83FR
Food Contact	
FDA, CFR21 Part 177	540P, 919, 919J, 919U, 929, 939, STW, SCW, SCWV, SCWV-FS, PCW
Natural Gas Service: For Vehicles and Dispensing Systems	
ANSI CSA NGV 4.2; NFPA 52; CSA 12.52 Class A, Class D, Class B**	5CNG; **5CNG-8
ANSI CSA NGV 3.1; NFPA 52; CSA 12.3, Class C	CNGRP
ECE-R110	5CNG factory built assemblies, 8LPG
ECE-R67	8LPG
Hydraulic Service:	
SAE 100R1AT	HFSR, 560TJ
SAE 100R7	540N, 540P, 510D, 518C, 518D, 55LT, 510C (less-2)
SAE 100R8	520N, 528N, 580N, 588N
SAE 100R14A	919, 919J, 919U, 929
SAE 100R14B	919B, 919BJ, 929B, 929BJ
SAE 100R17	D6R, H6, R6, 563TJ, 563LT
SAE 100R18	53DM, 538DM
SAE 100R19	594TJ
Electrical, Non-Conductivity:	
SAE J517	518C, 518D, 528N, 588N, 538DM
DNV (with approved fittings only)	
Det Norski (Norwegian) Veritas Marine Steel Ships, Mobile Offshore & Fixed Offshore Drilling Units	510C, 518C, 518D, 520N, 528N, 540N, 575X, 575XN, 580N, 588N
Breathing Air Applications:	
CGA (Compressed Gas Association)-G7.1-1 Grade E Breathing Air	527BA
NFPA 1901	527BA
United States Pharmacopoeia	
USP Class VI	SCW, STW, SCWV, NCW, PCW

A
Hose

B
Tubing

C
Coiled Air Hose & Fittings

D
Transportation

E
Fittings

F
Tooling, Equipment & Accessories

G
General Technical

PTFE Hose Chemical Resistance

Summary

Within normal use, temperatures, fluoropolymers are attacked by so few chemicals that it is easier to describe the exceptions rather than list the chemicals they are compatible with.

DO NOT USE FLUOROPLASTICS WITH THE FOLLOWING:

- Alkali metals such as elemental sodium, potassium, lithium, etc. The alkali metals remove fluorine from the polymer molecule.
- Extremely potent oxidizers, fluorine (F₂) and related compounds (e.g., chlorine trifluoride, ClF₃). These can be handled by fluoropolymers, but only with great care, as fluorine is absorbed into the resins, and the mixture becomes sensitive to a source of ignition such as impact.
- 80% NaOH (Sodium Hydroxide) or KOH (Potassium Hydroxide), metal hydrides such as Boranes (e.g., B₂H₆), Aluminum Chloride, Ammonia (NH₃), certain Amines (R-NH₂) and imines (R=NH) and 70% Nitric Acid at temperatures near the suggested service limit.

WARNING

FAILURE OR IMPROPER SELECTION OR IMPROPER USE OF THE PRODUCTS AND/OR SYSTEMS DESCRIBED HEREIN OR RELATED ITEMS CAN CAUSE DEATH, PERSONAL INJURY AND PROPERTY DAMAGE.

This document and other information from Parker Hannifin Corporation, its subsidiaries and authorized distributors provide product and/or system options for further investigation by users having technical expertise. It is important that you analyze all aspects of your application and review the information concerning the product or system in the current product catalog. Due to the variety of operating conditions and applications for these products or systems, the user, through its own analysis and testing, is solely responsible for making the final selection of the products and systems and assuring that all performance, safety and warning requirements of the application are met.

The products described herein, including without limitation, product features, specifications, designs, availability and pricing, are subject to change by Parker Hannifin Corporation and its subsidiaries at any time without notice.

Hose Construction

Hose Core, Reinforcement, Cover

Thermoplastic Hose Construction

Core

Contains Media
Materials: Nylon, Polyethylene, Polyurethane, Copolyester

Reinforcement

Provides Resistance to Internal Pressure
Materials: Fiber (Nylon, Polyester, Aramid), Steel, Stainless Steel

Cover

Protects Reinforcement
Advantages: Aesthetics, Color and Marking
Materials: Polyurethane, Nylon, Synthetic Rubber, Copolyester, and TPV

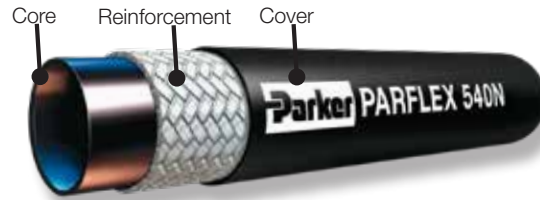

TOUGHJACKET™ Covers

Manufactured from Parflex
TOUGHJACKET™ Polyurethane
and designed to withstand the
strains of demanding use.

Look for the TJ - Currently found on
560TJ, 563TJ, 590TJ and 594TJ

TOUGHJACKET

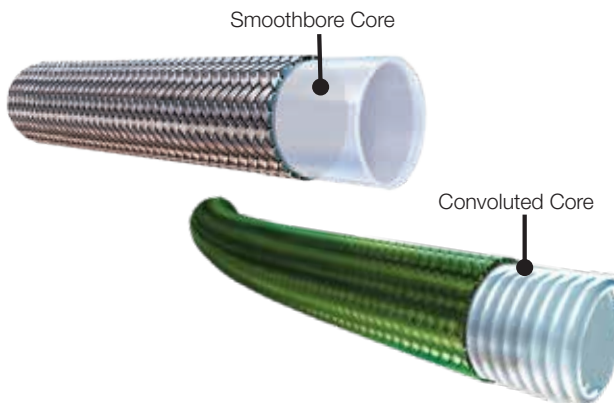

Fluoropolymer Hose Construction

Core

Contains Media
Materials: PTFE
Style: Smoothbore or Convuluted

Reinforcement

Provides Resistance to Internal Pressure
Materials: Stainless Steel, Polypropylene
and Nomex®

Cover or Protective Sleeve

Protects Reinforcement
Materials: Silicone, Polyolefin, Polyurethane

A
Hose

B
Tubing

C
Coiled Air Hose
& Fittings

D
Transportation

E
Fittings

F
Tooling,
Equipment
& Accessories

G
General
Technical

Construction/Specifications

Thermoplastic Hose, psi

Reinforcement Type	PSI Thermoplastic Hose Working Pressure												
		3/32	1/8	3/16	1/4	5/16	3/8	1/2	5/8	3/4	1		
	Dash Size	-1.5	-2	-3	-4	-5	-6	-8	-10	-12	-16		
Hose	Description		psi	psi	psi	psi	psi	psi	psi	psi	psi		
Wire	CNGRP*	Regulated Pressure CNG							500	500			
	D6R/D6RX	Hybrid® SAE 100R17 Hydraulic Hose				3045	3045	3045	3045	3045	3045		
	H6	Low Temperature SAE 100R17 Hydraulic Hose				3045	3045	3045	3045	3045			
	HFSR	Hybrid® SAE 100R1AT Hydraulic Hose				3263	3118	2611	2500		1523	1276	
	HFS2R	Hybrid® Hydraulic Hose				5076		4061	3553	2784	2277	2030	
	R6	Abrasion King, SAE 100R17 Hydraulic Hose				3000		3000	3000	3000	3000		
	HTB/HTBR	Eliminator® Hybrid® Hydraulic Hose				7000		5500	5000	4000	4000	3500	
	560TJ	SAE 100R1AT TOUGHJACKET™			3626	3263	3118	2750	2500	2000	1750		
	563TJ	SAE 100R17 TOUGHJACKET™				3045		3045	3045	3045	3045	3045	
	563LT	Constant Pressure Low Temperature						3045	3045	3045			
	590TJ	General Hydraulic TOUGHJACKET™				5076		4061	3553		2500	2030	
	594TJ	SAE 100R19 TOUGHJACKET™				4061		4061	4061	4061	4061		
	Fiber	510C	SAE 100R7 Hydraulic Hose <small>Pending obsolescence see 510D/518D</small>		2500	3250	3000	2500	2250	2250		1250	1000
		510D	SAE 100R7 Hydraulic Hose			3250	3000	2500	2250	2250	2750	1250	1000
518C		SAE 100R7 Non-conductive Hose <small>Pending obsolescence see 510D/518D</small>		2500**	3250**	3000**	2500**	2250**	2250**		1250**	1000**	
518D		SAE 100R7 Non-conductive Hose			3000**	3250**	3000**	2500**	2250**	2250**	2750**	1250**	1000**
520N / 528N		SAE 100R8 Hydraulic Hose			5000	5000	4500	4000	3500				
527BA		Breathing Air Refill Hose			7000	7000							
53DM		SAE 100R18 Low Temperature Hydraulic Hose				3000		3000	3000	3000	3000		
538DM		SAE 100R18 Low Temperature Hydraulic Hose Non-Conductive						3000					
540N		SAE 100R7 - Hydraulic Hose <small>Pending obsolescence see 510D/518D</small>		3000	3000	2750	2500	2250	2000		1250		
540P		SAE 100R7 Specialty Water Hose				2750		2250	2000				
55LT		SAE 100R7 Low Temperature Hydraulic Hose			3000	3250	3000	2500	2250	2000			
56DH		Diagnostic Hose		6000	6000								
575X / 575XN		Fast Response Hydraulic Hose			5000	5000		5000	5000		5000	5000	
580N / 588N		SAE 100R8 High Pressure Hydraulic 588N - Non-conductive							3500	2750	2250	2000	
1035HT	High Temperature Power Cleaning				1750								
83FR	DuraGard™ General Purpose Polyurethane				300		300	300		300			
B9	General Purpose Transfer Hose			250	250	250	250	250	250				
5CNG	Compressed Natural Gas Hose				5000		5000	5000		5000	5000		
8LPG	Propane & Natural Gas Hose			435	435	435	435						
HLB/HLBD	SAE 100R7 Hydraulic & Lubrication Hose			3000	3000								
MSH	Marine Steering Hose					1000	1000						
MSXL	Fast Response Marine Steering Hose					1500							
PTH	Marine Power Tilt Hose			3000									
S5N	Sewer Cleaning - Lateral Cleaning							4000					
S6	Sewer Cleaning									2500	2500		
S9	Sewer Cleaning									3000	3000		

* Sizing for -10 is 1/2"; for -12 is 5/8"

**View actual hose chart for ANSI pressure ratings

Legend F - Fiber H - Copolyester U - Polyurethane
 N - Nylon O - Polyethylene UTJ - TOUGHJACKET™ Polyurethane
 R - Smooth Synthetic Rubber S - Silicone X - TPV

Construction/Specifications

Thermoplastic Hose, psi

A
Hose

PSI Thermoplastic Hose Working Pressure									Reinforcement Type
Core Tube	Reinforcement Material	Cover Material	SAE Specification	Additional Specifications	Page #	Description	Hose		
N	Wire	X	-	ANSI CSA NGV 3.1; NFPA 52; CSA 12.3, Class C	A-60	Regulated Pressure CNG	CNGRP*	Wire	
H	Wire	R	100R17	MSHA/ ISO 11237 Type R17	A-32	Hybrid® SAE 100R17 Hydraulic Hose	D6R/D6RX		
H	Wire	H	100R17		A-35	Low Temperature SAE 100R17 Hydraulic Hose	H6		
H	Wire	R	100R1AT		A-33	Hybrid® SAE 100R1AT Hydraulic Hose	HFSR		
H	Wire	R	-	MSHA	A-34	Hybrid® Hydraulic Hose	HFS2R		
H	Wire	F	100R17		A-36	Abrasion King, SAE 100R17 Hydraulic Hose	R6		
H	Wire	R	-	MSHA	A-37	Eliminator® Hybrid® Hydraulic Hose	HTB/HTBR		
H	Wire	UTJ	100R1AT	MSHA	A-38	SAE 100R1AT TOUGHJACKET™	560TJ		
H	Wire	H	100R17	MSHA	A-39	SAE 100R17 TOUGHJACKET™	563TJ		
H	Wire	UTJ	100R17		A-40	Constant Pressure Low Temperature	563LT		
H	Wire	UTJ	-	MSHA	A-41	General Hydraulic TOUGHJACKET™	590TJ		
H	Wire	UTJ	100R19	MSHA	A-42	SAE 100R19 TOUGHJACKET™	594TJ		
H	Fiber	U	100R7***	MSHA***, DNV	A-43	SAE 100R7 Hydraulic Hose	510C	Coiled Air Hose & Fittings	
N	Fiber	U	100R7		A-44	SAE 100R7 Hydraulic Hose	510D		
H	Fiber	U	100R7	ANSI A92.2, DNV	A-45	SAE 100R7 Non-conductive Hose	518C		
N (H-16)	Fiber	U	100R7	ANSI A92.2, DNV	A-46	SAE 100R7 Non-conductive Hose	518D		
N	Fiber	U	100R8	MSHA***, DNV	A-47	SAE 100R8 Hydraulic Hose	520N / 528N	D Transportation	
N	Fiber	U	-	CGA / NFPA 1901	A-48	Breathing Air Refill Hose	527BA		
H	Fiber	H	100R18		A-51	SAE 100R18 Low Temperature Hydraulic Hose	53DM		
H	Fiber	H	100R18		A-51	SAE 100R18 Low Temperature Hydraulic Hose Non-Conductive	538DM		
N	Fiber	U	100R7	MSHA	A-49	SAE 100R7 - Hydraulic Hose	540N	M Fittings	
O	Fiber	U	100R7	FDA	A-50	SAE 100R7 Specialty Water Hose	540P		
H	Fiber	H	100R7		A-52	SAE 100R7 Low Temperature Hydraulic Hose	55LT		
N	Fiber	U	-	MSHA***	A-53	Diagnostic Hose	56DH		
N	Fiber	U	-	MSHA***, DNV	A-54	Fast Response Hydraulic Hose	575X/575XN		
N	Fiber	U	100R8	MSHA, DNV	A-55	SAE 100R8 High Pressure Hydraulic 588N - Non-conductive	580N/588N		
N	Fiber	U	-		A-57	High Temperature Power Cleaning	1035HT		
U	Fiber	U	UL94HB	MSHA	A-56	DuraGard™ General Purpose Polyurethane	83FR		
U	Fiber	U	-		A-58	General Purpose Transfer Hose	B9		
N	Fiber	U	-	ANSI CSA NGV 4.2; ECE R110***; NFPA 52; CSA 12.52 Class A, Class D, Class B***	A-59	Compressed Natural Gas Hose	5CNG		
N	Fiber	N	-	ECE R67 Class 1, ECE R110 CNG Class 6, CSA Certified	A-61	Propane & Natural Gas Hose	8LPG	Tooling, Equipment & Accessories	
N and H	Fiber	U	-	MSHA	A-62	SAE 100R7 Hydraulic & Lubrication Hose	HLB/HLBD		
N	Fiber	U	-		A-63	Marine Steering Hose	MSH		
N	Fiber	U	-		A-64	Fast Response Marine Steering Hose	MSXL		
N	Fiber / SS Wire	U	-		A-65	Marine Power Tilt Hose	PTH		
N	Fiber	U	-		A-66	Sewer Cleaning - Lateral Cleaning	SSN		
H	Fiber	U	-		A-67	Sewer Cleaning	S6		
H	Fiber	U	-		A-68	Sewer Cleaning	S9		

***View Government & Agency Specifications for exceptions, pg. A-7

Legend	F - Fiber	H - Copolyester	U - Polyurethane
	N - Nylon	O - Polyethylene	UTJ - TOUGHJACKET™ Polyurethane
	R - Smooth Synthetic Rubber	S - Silicone	X - TPV

G
General Technical

Construction/Specifications

Fluoropolymer Hose, psi

Reinforcement Type		PSI Fluoropolymer Hose Working Pressures														
		Fractional Size		Nominal Sizes												
				1/8	3/16 15/64	1/4	5/16	13/32 7/16	1/2	5/8	7/8 29/32	1-1/8	1/8	1/4	3/8	1/2
		Dash Size		-3	-4	-5	-6	-8	-10	-12	-16	-20	-3	-4	-6	-8
Hose	Description	psi	psi	psi	psi	psi	psi	psi	psi	psi	psi	psi	psi	psi	psi	
B Tubing	919	PTFE Hose		3000	3000	2500	2000	1500	1200	1000	625					
	919B	PTFE Hose with static-dissipative core		3000	3000	2500	2000									
	C Coiled Air Hose & Fittings	919J	Silicone Covered PTFE Hose		3000	3000	2500	2000	1500	1200	1000					
		919BJ	Silicone Covered PTFE Hose with static-dissipative core		3000	3000	2500	2000	1500	1200	1000					
		919U	High Abrasion Resistance PTFE Hose		3000		2500	2000		1200	1000					
		929	Heavy Wall PTFE Hose		3000		2500	2000								
		929B	Heavy Wall PTFE Hose with static-dissipative core		3000		2500	2000		1200	1250					
		929BJ	Silicone Covered PTFE Hose with static-dissipative core		3000		2500	2000		1200	1250					
		D Transportation	939	Convuluted PTFE Hose											1500	1350
939B			Convuluted PTFE Hose with static-dissipative core											1500	1350	1000
944B			High Pressure PTFE Hose with static-dissipative core				4500	4500	4000	4000	4000					
955B	High Pressure PTFE Hose with static-dissipative core			5500		5500	5500	5500	5500	5500						
STW Z-STW*	PAGE Heavy Wall PTFE Hose *Double Braid												3000	2000	1750	
STB Z-STB*	PAGE Heavy Wall PTFE Hose with static-dissipative core *Double Braid												3000	2000	1750	
SCW	PAGE Convuluted PTFE Hose												1500	1500	1500	
SCB	PAGE Convuluted PTFE Hose with static-dissipative core												1500	1500	1500	
SCWV	PAGE Heavy Wall Convuluted PTFE Hose														1500	
E Fittings	SCBV	PAGE Heavy Wall Convuluted PTFE Hose with static-dissipative core													1500	
	F Other	NCW	PAGE Nomex Braid Convuluted											725	400	280
		NCB	PAGE Nomex Braid Convuluted with static-dissipative core											725	400	280
		PCW	PAGE Polypropylene Braid Convuluted											350	350	350
PCB		PAGE Polypropylene Braid Convuluted with static-dissipative core											350	350	350	

*Z indicates double braid for sizes over 1".

Legend

PTFE - Polytetrafluoroethylene

PTFE-S - Polytetrafluoroethylene, Static Dissipative

U - Polyurethane

NB - Nomex Braid

PP - Polypropylene

S - Silicone

Construction/Specifications

Fluoropolymer Hose, psi

A Hose

PSI Fluoropolymer Construction and Specifications															Reinforcement Type
									Fractional Size					Hose	
3/4	1	1 1/4	1 1/2	2	2-1/2	3	4	Core Tube	Reinforcement Material	Cover Material	Page #	Description	Hose		
-12	-16	-20	-24	-32	-40	-48	-64								
psi	psi	psi	psi	psi	psi	psi	psi								
								PTFE	SS Wire	—	A-69	PTFE Hose	919	Wire	
								PTFE-S	SS Wire	—	A-69	PTFE Hose with static-dissipative core	919B		
								PTFE	SS Wire	S	A-70	Silicone Covered PTFE Hose	919J		
								PTFE-S	SS Wire	S	A-70	Silicone Covered PTFE Hose with static-dissipative core	919BJ		
								PTFE	SS Wire	U	A-71	High Abrasion Resistance PTFE Hose	919U		
								PTFE	SS Wire	—	A-72	Heavy Wall PTFE Hose	929		
								PTFE-S	SS Wire	—	A-72	Heavy Wall PTFE Hose with static-dissipative core	929B		
								PTFE-S	SS Wire	S	A-73	Silicone Covered PTFE Hose with static-dissipative core	929BJ		
	1100	1000	1000	750	250			PTFE	SS Wire	—	A-74	Convuluted PTFE Hose	939		
	1100	1000	1000	1000	1000			PTFE-S	SS Wire	—	A-74	Convuluted PTFE Hose with static-dissipative core	939B		
								PTFE-S	SS Wire	—	A-75	High Pressure PTFE Hose with static-dissipative core	944B		
								PTFE-S	SS Wire	—	A-76	High Pressure PTFE Hose with static-dissipative core	955B		
	1000	1000 1200	1000*	900*				PTFE	SS Wire	—	A-77	PAGE Heavy Wall PTFE Hose *Double Braid	STW Z-STW*		
	1000	1000 1200	1000*	900*				PTFE-S	SS Wire	—	A-77	PAGE Heavy Wall PTFE Hose with static-dissipative core *Double Braid	STB Z-STB*		
	1200	1000	750	650	450			PTFE	SS Wire	—	A-78	PAGE Convuluted PTFE Hose	SCW		
	1200	1000	750	650	450			PTFE-S	SS Wire	—	A-78	PAGE Convuluted PTFE Hose with static-dissipative core	SCB		
	1200	1000	750	650	450	200	175	150	PTFE	SS Wire	—	A-79	PAGE Heavy Wall Convuluted PTFE Hose	SCWV	
	1200	1000	750	650	450	200	175	150	PTFE-S	SS Wire	—	A-79	PAGE Heavy Wall Convuluted PTFE Hose with static-dissipative core	SCBV	
	200	200							PTFE	NB	—	A-81	PAGE Nomex® Braid Convuluted	NCW	
	200	200							PTFE-S	NB	—	A-81	PAGE Nomex® Braid Convuluted with static-dissipative core	NCB	
	350	350	350	350	350				PTFE	PP	—	A-80	PAGE Polypropylene Braid Convuluted	PCW	
	350	350	350	350	350				PTFE-S	PP	—	A-80	PAGE Polypropylene Braid Convuluted with static-dissipative core	PCB	

*Z indicates double braid for sizes over 1".

Legend

PTFE – Polytetrafluoroethylene

PTFE-S – Polytetrafluoroethylene, Static Dissipative

U – Polyurethane

NB - Nomex Braid

PP - Polypropylene

S - Silicone

B Tubing

C Coiled Air Hose & Fittings

D Transportation

E Fittings

F Tooling, Equipment & Accessories

G General Technical

Construction/Specifications

Thermoplastic Hose, MPa

Reinforcement Type	PSI Thermoplastic Hose Working Pressures											
			3/32	1/8	3/16	1/4	5/16	3/8	1/2	5/8	3/4	1
	Dash Size		-1.5	-2	-3	-4	-5	-6	-8	-10	-12	-16
	Hose	Description	MPa	MPa	MPa	MPa	MPa	MPa	MPa	MPa	MPa	MPa
Wire	CNGRP*	Regulated Pressure CNG								3.5	3.5	
	D6R/D6RX	Hybrid® SAE 100R17 Hydraulic Hose				21.0	21.0	21.0	21.0	21.0	21.0	21.0
	H6	Low Temperature SAE 100R17 Hydraulic Hose				21.0	21.0	21.0	21.0	21.0	21.0	
	HFSR	Hybrid® SAE 100R1AT Hydraulic Hose				22.5	21.5	18.0	17.2		10.5	8.8
	HFS2R	Hybrid® Hydraulic Hose				35.0		28.0	24.5	19.2	15.7	14.0
	R6	Abrasion King, SAE 100R17 Hydraulic Hose				20.7		20.7	20.7	20.7	20.7	
	HTB/HTBR	Eliminator® Hybrid® Hydraulic Hose				48.3		37.9	34.5	27.6	27.6	24.1
	560TJ	SAE 100R1AT TOUGHJACKET™			25.0	22.5	21.5	19.0	17.2	13.8	12.1	
	563TJ	SAE 100R17 TOUGHJACKET™				21.0		21.0	21.0	21.0	21.0	21.0
	563LT	Constant Pressure Low Temperature						21.0	21.0	21.0		
	590TJ	General Hydraulic TOUGHJACKET™				35.0		28.0	24.5		17.2	14.0
	594TJ	SAE 100R19 TOUGHJACKET™				28.0		28.0	28.0	28.0	28.0	
	Fiber	510C	SAE 100R7 Hydraulic Hose <small>Pending obsolescence see 510D/518D</small>		17.2	22.4	20.7	17.2	15.5	15.5		8.7
510D		SAE 100R7 Hydraulic Hose			22.4	21.0	17.5	15.8	15.8	19.2	8.8	7.0
518C		SAE 100R7 Non-conductive Hose <small>Pending obsolescence see 510D/518D</small>		15.8**	22.4**	21.0**	17.5**	15.8**	15.8**		8.8**	7.0**
518D		SAE 100R7 Non-conductive Hose		21.0**	22.4**	21.0**	17.5**	15.8**	15.8**	19.2**	8.8**	7.0**
520N / 528N		SAE 100R8 Hydraulic Hose			34.5	34.5	31.0	27.6	24.1			
527BA		Breathing Air Refill Hose			48.3	48.3						
53DM		SAE 100R18 Low Temperature Hydraulic Hose				20.7		20.7	20.7	20.7	20.7	
538DM		SAE 100R18 Low Temperature Hydraulic Hose, Non-conductive						20.7				
540N		SAE 100R7 - Hydraulic Hose <small>Pending obsolescence see 510D/518D</small>		20.7	20.7	19.0	17.2	15.5	13.8		8.6	
540P		SAE 100R7 Specialty Water Hose				19.0		15.5	13.8			
55LT		SAE 100R7 Low Temperature Hydraulic Hose		20.7	22.4	20.7	17.2	15.5	13.8			
56DH		Diagnostic Hose	41.4	41.4								
575X / 575XN		Fast Response Hydraulic Hose			34.5	34.5		34.5	34.5		34.5	34.5
580N / 588N		SAE 100R8 High Pressure Hydraulic 588N - Non-conductive							24.1	19.0	15.5	13.8
1035HT		High Temperature Power Cleaning				12.1						
83FR	DuraGard™ General Purpose Polyurethane				2.1		2.1	2.1		2.1		
B9	General Purpose Transfer Hose			1.7	1.7	1.7	1.7	1.7	1.7			
5CNG	Compressed Natural Gas Hose				34.5		34.5	34.5		34.5	34.5	
8LPG	Propane & Natural Gas Hose			3.0	3.0	3.0	3.0					
HLB/HLBD	SAE 100R7 Hydraulic & Lubrication Hose		20.7	20.7								
MSH	Marine Steering Hose					6.9	6.9					
MSXL	Fast Response Marine Steering Hose					10.3						
PTH	Marine Power Tilt Hose		20.7									
S5N	Sewer Cleaning - Lateral Cleaning							28.0				
S6	Sewer Cleaning									17.2	17.2	
S9	Sewer Cleaning									20.7	20.7	

* Sizing for -10 is 1/2"; for -12 is 5/8"

**View actual hose chart for ANSI pressure ratings

Legend F - Fiber H - Copolyester U - Polyurethane
 N - Nylon O - Polyethylene UTJ - TOUGHJACKET™ Polyurethane
 R - Smooth Synthetic Rubber S - Silicone X - TPV

Construction/Specifications

Thermoplastic Hose, MPa

A
Hose

PSI Thermoplastic Construction and Specifications									Reinforcement Type
Core Tube	Reinforcement Material	Cover Material	SAE Specification	Additional Specifications	Page #	Description	Hose		
N	Wire	X	-	ANSI CSA NGV 3.1; NFPA 52; CSA 12.3, Class C	A-60	Regulated Pressure CNG	CNGRP*	Wire	
H	Wire	R	100R17	MSHA/ ISO 11237 Type R17	A-32	Hybrid® SAE 100R17 Hydraulic Hose	D6R/D6RX		
H	Wire	H	100R17		A-35	Low Temperature SAE 100R17 Hydraulic Hose	H6		
H	Wire	R	100R1AT		A-33	Hybrid® SAE 100R1AT Hydraulic Hose	HFSR		
H	Wire	R	-	MSHA	A-34	Hybrid® Hydraulic Hose	HFS2R		
H	Wire	F	100R17		A-36	Abrasion King, SAE 100R17 Hydraulic Hose	R6		
H	Wire	R	-	MSHA	A-37	Eliminator® Hybrid® Hydraulic Hose	HTB/HTBR		
H	Wire	UTJ	100R1AT	MSHA	A-38	SAE 100R1AT TOUGHJACKET™	560TJ		
H	Wire	UTJ	100R17	MSHA	A-39	SAE 100R17 TOUGHJACKET™	563TJ		
H	Wire	H	100R17		A-40	Constant Pressure Low Temperature	563LT		
H	Wire	UTJ	-	MSHA	A-41	General Hydraulic TOUGHJACKET™	590TJ		
H	Wire	UTJ	100R19	MSHA	A-42	SAE 100R19 TOUGHJACKET™	594TJ		
H	Fiber	U	100R7***	MSHA***, DNV	A-43	SAE 100R7 Hydraulic Hose	510C	Coiled Air Hose & Fittings	
N	Fiber	U	100R7		A-44	SAE 100R7 Hydraulic Hose	510D		
H	Fiber	U	100R7	ANSI A92.2, DNV	A-45	SAE 100R7 Non-conductive Hose	518C		
N (H-16)	Fiber	U	100R7	ANSI A92.2, DNV	A-46	SAE 100R7 Non-conductive Hose	518D		
N	Fiber	U	100R8	MSHA***, DNV	A-47	SAE 100R8 Hydraulic Hose	520N / 528N	Transportation	
N	Fiber	U	-	CGA / NFPA 1901	A-48	Breathing Air Refill Hose	527BA		
H	Fiber	H	100R18		A-51	SAE 100R18 Low Temperature Hydraulic Hose	53DM		
H	Fiber	H	100R18		A-51	SAE 100R18 Low Temperature Hydraulic Hose, Non-conductive	538DM		
N	Fiber	U	100R7	MSHA	A-49	SAE 100R7 - Hydraulic Hose	540N		
O	Fiber	U	100R7	FDA	A-50	SAE 100R7 Specialty Water Hose	540P		
H	Fiber	H	100R7		A-52	SAE 100R7 Low Temperature Hydraulic Hose	55LT		
N	Fiber	U	-	MSHA***	A-53	Diagnostic Hose	56DH		
N	Fiber	U	-	MSHA***, DNV	A-54	Fast Response Hydraulic Hose	575X/575XN		
N	Fiber	U	100R8	MSHA, DNV	A-55	SAE 100R8 High Pressure Hydraulic 588N - Non-conductive	580N/588N		
N	Fiber	U	-		A-57	High Temperature Power Cleaning	1035HT	Fittings	
U	Fiber	U	UL94HB	MSHA	A-56	DuraGard™ General Purpose Polyurethane	83FR		
U	Fiber	U	-		A-58	General Purpose Transfer Hose	B9		
N	Fiber	U	-	ANSI CSA NGV 4.2; ECE R110***; NFPA 52; CSA 12.52 Class A, Class D, Class B***	A-59	Compressed Natural Gas Hose	5CNG		
N	Fiber	N	-	ECE R67 Class 1, ECE R110 CNG Class 6, CSA Certified	A-61	Propane & Natural Gas Hose	8LPG	Tooling, Equipment & Accessories	
N and H	Fiber	U	-	MSHA	A-62	SAE 100R7 Hydraulic & Lubrication Hose	HLB/HLBD		
N	Fiber	U	-		A-63	Marine Steering Hose	MSH		
N	Fiber	U	-		A-64	Fast Response Marine Steering Hose	MSXL		
N	Fiber / SS Wire	U	-		A-65	Marine Power Tilt Hose	PTH		
N	Fiber	U	-		A-66	Sewer Cleaning - Lateral Cleaning	S5N		
H	Fiber	U	-		A-67	Sewer Cleaning	S6		
H	Fiber	U	-		A-68	Sewer Cleaning	S9		

***View Government & Agency Specifications for exceptions, pg. A-7

Legend	F - Fiber	H - Copolyester	U - Polyurethane
	N - Nylon	O - Polyethylene	UTJ - TOUGHJACKET™ Polyurethane
	R - Smooth Synthetic Rubber	S - Silicone	X - TPV

B
Tubing

C
Coiled Air Hose & Fittings

D
Transportation

E
Fittings

F
Tooling, Equipment & Accessories

G
General Technical

Construction/Specifications

Fluoropolymer Hose, MPa

Reinforcement Type		PSI Fluoropolymer Hose Working Pressures																
		Fractional Size		Nominal Sizes														
				1/8	3/16 15/64	1/4	5/16	13/32 7/16	1/2	5/8	7/8 29/32	1-1/8	1/8	1/4	3/8	1/2	5/8	
		Dash Size		-3	-4	-5	-6	-8	-10	-12	-16	-20	-3	-4	-6	-8	-10	
Hose	Description	MPa	MPa	MPa	MPa	MPa	MPa	MPa	MPa	MPa	MPa	MPa	MPa	MPa	MPa			
B Tubing	919	PTFE Hose		20.7	20.7	17.2	13.8	10.3	8.3	6.9	4.3							
	919B	PTFE Hose with static-dissipative core		20.7	20.7	17.2	13.8											
	C Coiled Air Hose & Fittings	919J	Silicone Covered PTFE Hose		20.7	20.7	17.2	13.8	10.3	8.3	6.9							
		919BJ	Silicone Covered PTFE Hose with static-dissipative core		20.7	20.7	17.2	13.8	10.3	8.3	6.9							
		919U	High Abrasion Resistance PTFE Hose		20.7		17.2	13.8										
		929	Heavy Wall PTFE Hose		20.7		17.2	13.8										
		929B	Heavy Wall PTFE Hose with static-dissipative core		20.7		17.2	13.8		8.3	8.6							
		929BJ	Silicone Covered PTFE Hose with static-dissipative core		20.7		17.2	13.8		8.3	8.6							
		D Transportation	939	Convuluted PTFE Hose											10.3	9.3	6.9	
			939B	Convuluted PTFE Hose with static-dissipative core											10.3	9.3	6.9	
944B			High Pressure PTFE Hose with static-dissipative core				31.0	31.0	27.6	27.6	27.6							
955B			High Pressure PTFE Hose with static-dissipative core		37.9		37.9	37.9	37.9	37.9	37.9							
STW Z-STW*	PAGE Heavy Wall PTFE Hose *Double Braid											20.7	20.7	13.8	12.1			
STB Z-STB*	PAGE Heavy Wall PTFE Hose with static-dissipative core *Double Braid											20.7	20.7	13.8	12.1			
SCW	PAGE Convuluted PTFE Hose												10.3	10.3	10.3			
SCB	PAGE Convuluted PTFE Hose with static-dissipative core												10.3	10.3	10.3			
SCWV	PAGE Heavy Wall Convuluted PTFE Hose														10.3			
SCBV	PAGE Heavy Wall Convuluted PTFE Hose with static-dissipative core														10.3			
E Fittings	NCW	PAGE Nomex Braid Convuluted											5.0	2.8	1.9			
	NCB	PAGE Nomex Braid Convuluted with static-dissipative core											5.0	2.8	1.9			
	PCW	PAGE Polypropylene Braid Convuluted											10.3	10.3	10.3			
	PCB	PAGE Polypropylene Braid Convuluted with static-dissipative core											10.3	10.3	10.3			
F Tooling, Equipment & Accessories	Other																	

*Z indicates double braid for sizes over 1".

Legend

PTFE - Polytetrafluoroethylene PTFE-S - Polytetrafluoroethylene, Static Dissipative U - Polyurethane
 NB - Nomex Braid PP - Polypropylene S - Silicone

Construction/Specifications

Fluoropolymer Hose, MPa

A Hose

PSI Fluoropolymer Construction and Specifications															Reinforcement Type
3/4	1	1 1/4	1 1/2	2	2-1/2	3	4	Fractional Size							
-12 MPa	-16 MPa	-20 MPa	-24 MPa	-32 MPa	-40 MPa	-48 MPa	-64 MPa	Core Tube	Reinforcement Material	Cover Material	Page #	Description	Hose		
								PTFE	SS Wire	—	A-69	PTFE Hose	919	Wire	
								PTFE-S	SS Wire	—	A-69	PTFE Hose with static-dissipative core	919B		
								PTFE	SS Wire	S	A-70	Silicone Covered PTFE Hose	919J		
								PTFE-S	SS Wire	S	A-70	Silicone Covered PTFE Hose with static-dissipative core	919BJ		
								PTFE	SS Wire	U	A-71	High Abrasion Resistance PTFE Hose	919U		
								PTFE	SS Wire	—	A-72	Heavy Wall PTFE Hose	929		
								PTFE-S	SS Wire	—	A-72	Heavy Wall PTFE Hose with static-dissipative core	929B		
								PTFE-S	SS Wire	S	A-73	Silicone Covered PTFE Hose with static-dissipative core	929BJ		
	7.6	6.9	6.9	5.2	1.7			PTFE	SS Wire	—	A-74	Convuluted PTFE Hose	939		
	7.6	6.9	6.9	5.2	1.7			PTFE-S	SS Wire	—	A-74	Convuluted PTFE Hose with static-dissipative core	939B		
								PTFE-S	SS Wire	—	A-75	High Pressure PTFE Hose with static-dissipative core	944B		
								PTFE-S	SS Wire	—	A-76	High Pressure PTFE Hose with static-dissipative core	955B		
	6.9	6.9 8.3	6.9*	6.2*				PTFE	SS Wire	—	A-77	PAGE Heavy Wall PTFE Hose *Double Braid	STW Z-STW*		
	6.9	6.9 8.3	6.9*	6.2*				PTFE-S	SS Wire	—	A-77	PAGE Heavy Wall PTFE Hose with static-dissipative core *Double Braid	STB Z-STB*		
	8.3	6.9	5.2	4.5	3.1			PTFE	SS Wire	—	A-78	PAGE Convuluted PTFE Hose	SCW		
	8.3	6.9	5.2	4.5	3.1			PTFE-S	SS Wire	—	A-78	PAGE Convuluted PTFE Hose with static-dissipative core	SCB		
	8.3	6.9	5.2	4.5	3.1	1.4	1.2	1.0	PTFE	SS Wire	—	A-79	PAGE Heavy Wall Convuluted PTFE Hose	SCWV	
	8.3	6.9	5.2	4.5	3.1	1.4	1.2	1.0	PTFE-S	SS Wire	—	A-79	PAGE Heavy Wall Convuluted PTFE Hose with static-dissipative core	SCBV	
	1.4	1.4						PTFE	NB	—	A-81	PAGE Nomex® Braid Convuluted	NCW	Other	
	1.4	1.4						PTFE-S	NB	—	A-81	PAGE Nomex® Braid Convuluted with static-dissipative core	NCB		
	10.3	10.3	10.3	10.3	10.3			PTFE	PP	—	A-80	PAGE Polypropylene Braid Convuluted	PCW		
	10.3	10.3	10.3	10.3	10.3			PTFE-S	PP	—	A-80	PAGE Polypropylene Braid Convuluted with static-dissipative core	PCB		

*Z indicates double braid for sizes over 1".

Legend

PTFE – Polytetrafluoroethylene

PTFE-S – Polytetrafluoroethylene, Static Dissipative

U – Polyurethane

NB - Nomex Braid

PP - Polypropylene

S - Silicone

B Tubing

C Coiled Air Hose & Fittings

D Transportation

E Fittings

F Tooling, Equipment & Accessories

G General Technical

Selection of Hose Diameter

Flow Capacities at Recommended Flow Velocities

The nomogram below is provided as an aid in determining the correct hose size.

How to use the nomogram:
 Determine the proper flow rate your system requires, then connect a straight edge from the selected flow rate to the recommended velocity range. The required hose I.D. will appear at the intersection of the straight edge and the center column. If the straight edge passes through the scale between sizes listed, use the next larger I.D. hose.

Example: Locate 16 gallons per minute in the left-hand column and 20 feet per second in the right-hand column (the maximum recommended velocity range for pressure lines). Lay a straight edge across these two points.

The inside diameter required is shown in the center column at or above the straight edge. In this case, we need a hose I.D. of 0.625 (5/8") inch (or larger).

Use the same procedure for suction or return lines, except utilizing their respective maximum recommended velocities.

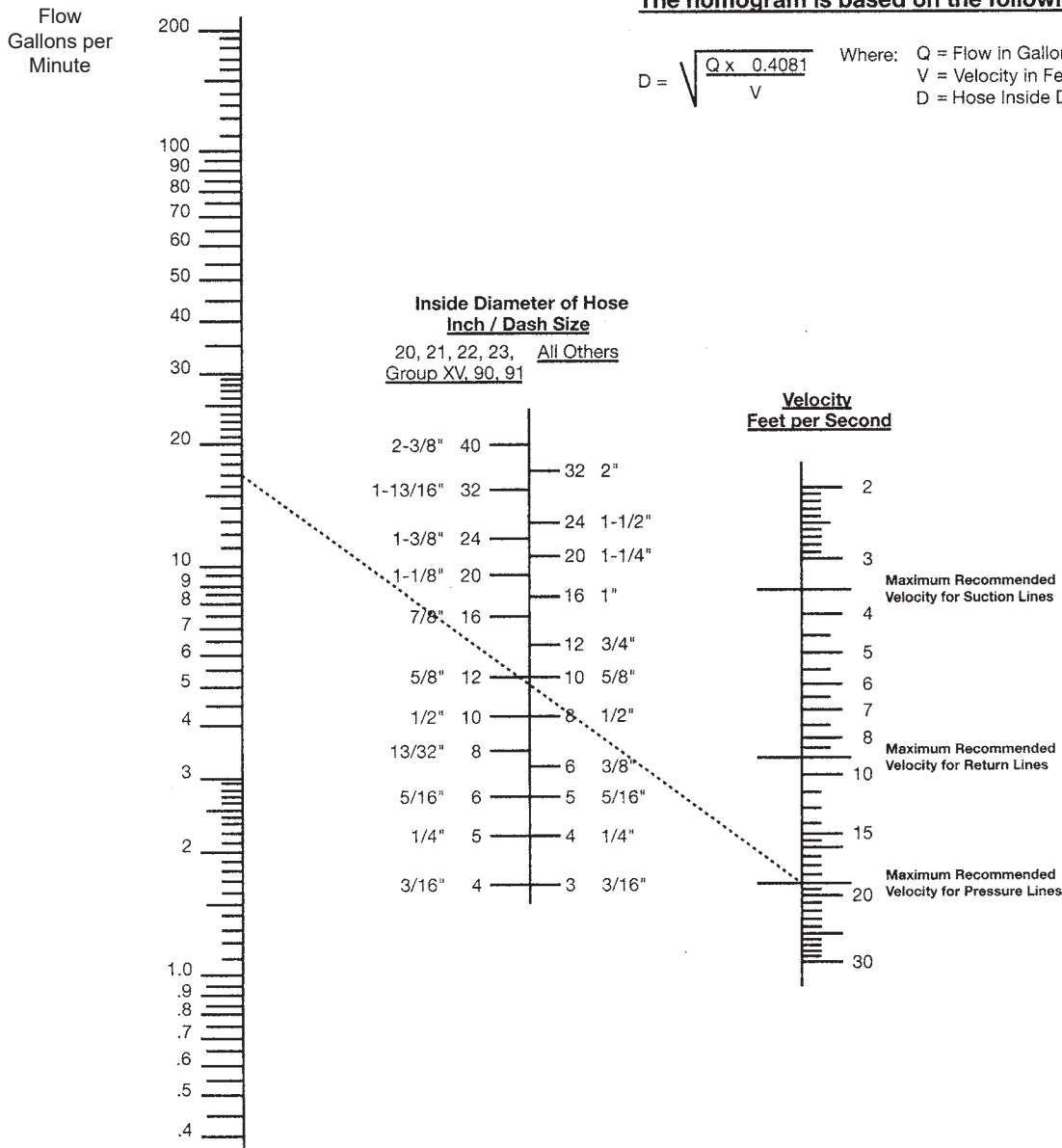

Calculation of Hose Length

For Over-the-Sheave applications

The exact cut-off length for an optimum over-the-sheave assembly depends on the particular mechanical arrangement of the machine. A method for finding an approximate starting point is as follows:

1. Assemble hose with one coupling as shown in diagram.
2. Measure hose length from point 1 to point 2 with hose taut.
LO = length
3. Calculation of insert allowance (x) may be found from the coupling dimension tabulations in the fittings section or from direct measurement on the coupling. A 1.5% stretch allowance is provided in the following formula.
4. Calculate hose cutoff hose cut length HCL:
 $HCL = 0.985 LO + 2X$
 Where HCL includes coupling, insert allowance on both ends.
5. Couple the remaining hose end, check crimp, and assemble on the machine.

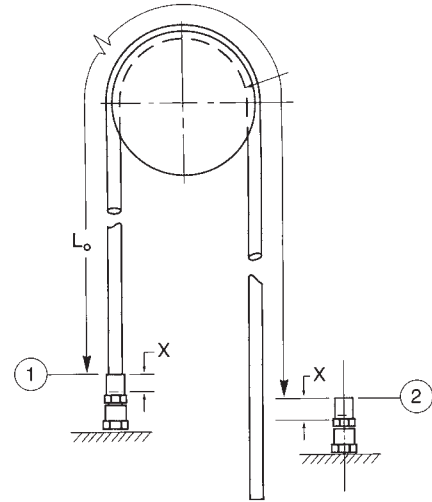

Selecting The Correct Hose

"STAMPED"

S

Size

The appropriate inside and outside diameters

T

Temperature

The ambient and minimum/maximum temperature of the material being conveyed

A

Application

External conditions including abrasion, climate, heat, flexing, routing and degrees of bending

M

Media

The composition of the substance being conveyed and chemical compatibility with the hose inner core and, if applicable, the outer cover

P

Pressure

The maximum vacuum or pressure of the system, including pressure spikes

E

Pressure

The appropriate end connection, material and attachment method for the application

D

Pressure

Testing, quality, packaging, and delivery requirements

A
Hose

B
Tubing

C
Coiled Air Hose
& Fittings

D
Transportation

E
Fittings

F
Tooling,
Equipment
& Accessories

G
General
Technical

Hose Material Features

Core, Reinforcement & Jacket

Core Tube

Material	Maximum Working Temperature	Features
Copolyester	Working Temperature: ranging from -70°F (-57°C) to 250°F (127°C)*	<ul style="list-style-type: none"> Good chemical resistance Superior flexibility in cold temperatures
Nylon	Working Temperature: ranging from -40°F (-40°C) to 230°F (110°C)*	<ul style="list-style-type: none"> Very good chemical resistance Maximum resistance to permeable fluids
Polyethylene	Working Temperature: ranging from -40°F (-40°C) to 150°F (66°C)*	<ul style="list-style-type: none"> Non-leaching Low moisture absorption
Polyurethane	Working Temperature: ranging from -40°F (-40°C) to 200°F (93°C)*	<ul style="list-style-type: none"> Excellent flexibility
PTFE	Working Temperature: ranging from -100°F (-73°C) to 500°F (260°C)*	<ul style="list-style-type: none"> Chemically inert, superior chemical resistance Lowest coefficient of friction Superior dielectric strength Exceptional heat resistance Non wetting

Reinforcement

Material	Maximum Working Temperature	Features
Fiber	Working Temperature: ranging from -70°F (-57°C) to 250°F (127°C)*	<ul style="list-style-type: none"> High density braid allows for compact braid O.D. Maximum impulse life Excellent flexibility
Steel Stainless Steel	Working Temperature: ranging from -100°F (-73°C) to 500°F (260°C)*	<ul style="list-style-type: none"> Low volumetric expansion Maximum strength reinforcement
Polypropylene	Working Temperature: ranging from 0°F (18°C) to 100°F (212°C)*	<ul style="list-style-type: none"> Light weight Excellent corrosion resistance
Nomex	Working Temperature: ranging from -100°F (-73°C) to 400°F (204°C)*	<ul style="list-style-type: none"> Very light weight Eliminates RFI issues Superior flexibility

Cover

Material	Maximum Working Temperature	Features
Copolyester	Working Temperature: ranging from -70°F (-57°C) to 250°F (121°C)*	<ul style="list-style-type: none"> Low coefficient of friction Superior flexibility in cold temperatures
Polyurethane	Working Temperature: ranging from -40°F (-40°C) to 200°F (93°C)*	<ul style="list-style-type: none"> Abrasion resistant Non-marring
Silicone	Working Temperature: ranging from -65°F (-54°C) to 450°F (232°C)*	<ul style="list-style-type: none"> Abrasion resistant Protects braiding Keeps hose cooler for operator safety
TPV	Working Temperature: ranging from -40°F (-40°C) to 250°F (121°C)*	<ul style="list-style-type: none"> Extremely durable Resistant to chemicals and weathering

Notes: * Temperatures listed are maximum and minimums typically associated with this material. However, other factors in the manufacturing process may limit the working temperature. Refer to the specific hose page for actual hose working temperature.

Hose Material Overview

Materials to Parflex Hose

Materials to Parflex Hose - Hose Core Tubes

Material Code for Hose Core Tubes	Material Name	Hose
H	Copolyester	D6R, H6, R6, HFSR, HFS2R, HTB, HTBR, 560TJ, 563LT, 563TJ, 590TJ, 594TJ, 510C, 518C, 53DM/538DM, 55LT, HLB, HLBD, S6, S9
N	Nylon	510D, 518D, 520N, 527BA, 528N, 540N, 56DH, 575X, 575XN, 580N, 588N, 1035HT, 5CNG, MSH, MSXL, PTH, S5N, 1035HT, CNGRP
O	Polyethylene	540P
PTFE	Fluoropolymer PTFE	919/919B, 919J, 919BJ, 919U, 929/929B, 929BJ, 939/939B, 944B, 955B, PCW/PCB, STW/STB, SCW/SCB, NCW/NCB, SCWV/SCBV, SCWV-FS/SCBV-FS
U	Polyurethane	83FR, B9

Materials to Parflex Hose - Hose Covers

Material Code for Hose Covers	Material Name	Hose
H	Low Temperature Copolyester	55LT, 53DM/538DM, 563LT
M	Silicone	919J, 919BJ, 929BJ
U	Polyurethane	560TJ, 563TJ, 590TJ, 594TJ, 510C, 518C, 518D, 520N, 528N, 527BA, 540N, 540P, 56DH, 575X, 580N, 588N, 83FR, 1035HT, B9, 5CNG, HLB, HLBD, MSH, PTH, S5N, S6, S9
UTJ	TOUGHJACKET Polyurethane	560TJ, 563TJ, 590TJ, 594TJ
N	Flexible Nylon	575XN
TPV	Thermoplastic Vulcanizate	CNGRP

Rating Codes:

- G Good to excellent. Little or no swelling, tensile or surface changes. Preferred choice.
- L Marginal or conditional. Noticeable effects but not necessarily indicating lack of serviceability. Further testing suggested for specific application. Very long-term effects such as stiffening or potential for crazing should be evaluated.
- P Poor or unsatisfactory. Not recommended without extensive and realistic testing.
- — Indicates that this was not tested.
- # For fluoropolymer. Indicates good chemical resistance but potential for excessive permeation.
- 2 See notes pg. A-25.
- 3 See notes pg. A-25.
- 4 See notes pg. A-25.
- 5 See notes pg. A-25.
- 6 See notes pg. A-25.
- 7 See notes pg. A-25.
- 8 See notes pg. A-25.

A
Hose

B
Tubing

C
Coiled Air Hose & Fittings

D
Transportation

E
Fittings

F
Tooling, Equipment & Accessories

G
General Technical

Compatibility Guide

Media to Hose Material

Media to Hose Material

Media	H	N	U/UTJ	PTFE	M	TPV
Acetaldehyde	G	L	L	G	P	L
Acetic Acid Glacial	L	L	L	G	L	L
Acetone	L	G	P	G	P	L
Acetylene	(2)	(2)	(2)	(2)	P	P
Air (4)	G	G	G	G	G	G
Ammonium Chloride	G	P	G	G	P	G
Ammonium Hydroxide	L	G	P	G	G	G
Anhydrous Ammonia	P	P	P	(8)	P	G
Aniline	P	P	P	G	P	L
Animal Oils (6)	G	G	G	G	P	P
Aromatic Hydrocarbons	L	G	L	G	P	P
Asphalt	G	G	G	G	P	L
Baygon (Insecticide)	L	G	P	G	-	-
Beer	G	G	G	G	G	G
Benzene	L	G	L	G	P	P
Brake Fluid (DOT #3)	-	G	P	G	P	L
Butane (2) (4)	G	G	L	#	P	P
Butter (6)	G	G	G	G	P	P
Calcium Chloride	G	(3)	G	G	G	G
Carbon Dioxide (4)	G	G	G	#	L	G
Carbon Monoxide (4)	G	(3)	G	#	G	G
Carbon Tetrachloride	L	G	P	G	P	P
Castor Oil	G	L	L	G	G	L
Chlorinated Hydrocarbon Base Fluids	L	G	L	G	P	P
Chlorinated Petroleum Oil	G	G	L	-	P	P
Chlorinated Solvents	P	(3)	P	G	P	P
Chlorine, Gaseous, Dry	P	P	P	#	P	P
Chlordane (Insecticide)	L	G	P	-	P	P
Chloroform	P	P	P	G	P	P
Chromic Acid	P	(3)	P	G	P	P
Citric Acid Solutions	G	G	L	G	G	G
Crude Petroleum Oil	G	G	G	G	P	P
Cyclohexane (2)	G	G	G	G	P	P
Cygon (Insecticide)	L	G	P	-	-	-
Diazin (Insecticide)	L	-	P	-	P	P
Diesel Fuel (2)	G	G	G	G	P	P
Diester Oils	L	G	P	G	P	P
Enamels	G	G	G	G	-	-
Ethanol (6)	G	G	L	G	P	G
Ethers	L	G	P	G	P	P
Ethylene Glycol	L	G	L	G	G	G
Ethylene Oxide	G	G	L	#	P	G
Fatty Acids	G	G	(3)	G	P	L
Formaldehyde	L	L	P	G	P	G
Formic Acid	P	P	P	G	P	G

Rating Code - pg. A-21
Notes - pg. A-25

(Cont.)

Tubing

Coiled Air Hose & Fittings

Transportation

Fittings

Tooling, Equipment & Accessories

General Technical

Compatibility Guide

Media to Hose Material

Media to Hose Material

Media	H	N	U/UTJ	PTFE	M	TPV
Freon 12 (5)	P	G	L	#	P	P
Freon 22 (5)	P	G	L	#	P	P
Fruit Juices	G	G	G	G	G	G
Fuel Oil (2)	G	G	L	G	P	P
Gas (Oil) (2)	G	G	G	G	P	P
Gas (Natural) (4)	(2)	(2)	(2)	(2)	P	P
Gasoline (2)	G	G	(3)	G	P	P
Glue	(3)	(3)	(3)	(3)	G	G
Glycerin	G	G	L	G	G	G
Glycols (to 135°F)	L	G	L	G	G	L
Grease (Petroleum base)	G	G	G	G	P	P
Heptachlor (Insecticide)	L	G	P	G	-	-
Hexane (2)	G	G	G	G	P	L
Houghto Safe-600 Series (Hydraulic fluid)	G	G	L	G	L	G
Houghto Safe-1000 Series (Phosphate esters)	L	G	P	G	P	G
Hydraulic Fluid (Petroleum base)	G	G	G	G	P	P
Hydraulic Fluid (Phosphate ester base)	L	G	L	G	P	G
Hydraulic Fluid (Water glycol base)	G	G	G	G	P	L
Hydraulic Oil (Petroleum base)	G	G	G	G	P	P
Hydrochloric Acid	P	L	P	G	P	L
Hydrofluoric Acid	P	P	P	G	P	P
Hydrogen, Gaseous (2) (4) (5)	G	G	G	-	P	G
Hydrolube (Hydraulic fluid/water glycol base)	G	G	L	G	P	G
IRUS 902 (Hydraulic fluid/water-oil emulsion)	G	G	G	G	-	-
Isocyanates (2)	L	L	L	G	-	-
IsoOctane (2)	G	G	G	G	P	P
Isopropyl Alcohol	G	G	L	G	G	L
Kerosene (2)	G	G	L	G	P	P
Ketones	L	G	P	G	P	P
Lacquer Solvents	L	G	P	G	P	P
Lactic Acid	P	G	P	G	L	G
Lime (Calcium oxide)	G	G	G	G	P	G
Lindol (Hydraulic fluid/phosphate esters)	L	G	P	G	G	G
Linseed Oil	G	G	G	G	G	L
LP - Gas	(2)	(2)	(2)	(2)	P	P
Lubricating Oils (Diester base)	L	G	P	G	P	P
Lubricating Oils (Petroleum base)	G	G	G	G	P	P
Malathion (Insecticide)	L	G	P	G	P	-
Magnesium Hydroxide	L	G	L	G	P	G
Magnesium Salts	-	G	G	G	G	G
Mercury	G	G	G	G	G	G
Meropa Oil (Sulphur base)	G	G	-	G	-	-
Methane	(2)	(2)	(2)	(2)	P	P
Methanol	G	G	P	G	G	G
Methoxychlor (Insecticide)	L	G	P	G	-	-

Rating Code - pg. A-21
Notes - pg. A-25

(Cont.)

A
Hose

B
Tubing

C
Coiled Air Hose
& Fittings

D
Transportation

M
Fittings

F
Tooling,
Equipment
& Accessories

G
General
Technical

Compatibility Guide

Media to Hose Material

Media to Hose Material

Media	H	N	U/UTJ	PTFE	M	TPV
Methyl Alcohol (6)	G	G	P	G	G	G
Methylene Chloride	P	L	P	G	P	P
Methyl Ethyl Ketone (MEK)	L	G	P	G	P	P
Methyl Ethyl Ketone Peroxide (MEKP)	-	L	P	G	L	-
Methyl Isobutyl Ketone (MIBK)	L	G	P	G	P	P
Milk (6)	G	G	G	G	G	G
Mineral Oil	G	G	G	G	P	P
Mineral Spirits	P	-	L	G	P	L
Motor Oils	G	G	G	G	P	-
Naphtha	L	G	P	G	P	P
Natural Gas (4)	(2)	(2)	(2)	(2)	P	P
Nitric Acid	P	P	P	G	P	P
Nitrobenzene	P	G	P	G	P	L
Nitrogen, Gaseous (4) (5)	G	G	G	G	G	G
Nitrous Oxide	-	L	-	#	G	-
Oil (SAE)	G	G	G	G	L	P
Oil of Turpentine	G	G	P	G	P	P
Oleic Acid	G	G	G	G	P	L
OS 45 Type 3 Hydraulic Fluid (Silicate esters)	L	G	L	-	P	-
Oxygen, Gaseous (4) (5) (6)	G	G	G	G	G	G
Ozone	L	P	L	G	G	G
Paint Solvents (Oil base)	L	G	L	G	-	L
Paint (Oil Base) (7)	G	G	G	G	P	P
Pentane (2)	G	G	L	G	P	G
Perchloric Acid	P	P	P	G	P	P
Perchloroethylene	P	P	P	G	P	P
Petroleum Ether	-	(2)	(2)	(2)	P	-
Petroleum Oils	G	G	G	G	P	P
Phenols	P	P	P	G	-	P
Phosphate Esters (above 135°F)	P	G	P	G	P	G
Phosphate Esters (to 135°F)	G	G	P	G	P	G
Polyol Esters	L	G	P	G	P	P
Potassium Hydroxide, 50%	P	P	P	G	G	G
Propane (4) (5)	(2)	(2)	(2)	(2)	P	P
Propylene Glycol	-	-	G	G	G	G
Pydraul F-9, 150, 160 (to 135°F)	G	G	P	G	-	P
Pydraul 312C, 625 (to 135°F)	P	G	P	G	P	P
Quintolubric 822 Fluid	-	G	G	G	-	-
Salt Water	(3)	(3)	(3)	G	G	G
Sevin (Insecticides in water)	G	G	G	G	-	-
Silicone Greases	G	G	G	G	P	L
Silicone Oils	G	G	G	G	P	L
Skydrol 500 & 7000	L	G	P	G	P	L
Soap Solutions	G	G	G	G	G	G

Rating Code - pg. A-21
Notes - pg. A-25

(Cont.)

Tubing

Coiled Air Hose & Fittings

Transportation

Fittings

Tooling, Equipment & Accessories

General Technical

Compatibility Guide

Media to Hose Material

Media to Hose Material

Media	H	N	U/UTJ	PTFE	M	TPV
Soda Water	G	G	G	G	G	G
Sodium Borate	G	G	G	G	G	G
Sodium Carbonate	(3)	(3)	(3)	(3)	G	G
Sodium Chloride Solutions	G	G	G	G	G	G
Sodium Hydroxide, 50%	L	P	P	G	G	G
Sodium Hypochlorite	L	P	P	G	P	G
Steam	P	P	P	G	P	G
Stoddard Solvent	P	G	P	G	P	P
Straight Synthetic Oils (Phosphate esters)	L	G	P	G	P	G
Sulfur	G	G	G	G	P	L
Sulfur Dioxide	P	L	L	G	P	G
Sulfur Hexafluoride Gas (4) (5)	G	G	G	G	P	L
Sulphuric Acid	P	P	P	G	P	P
Toluene	L	G	L	G	P	P
Toloul	L	G	L	G	-	-
Transmission Fluid	G	G	G	G	P	P
Trichloroethylene	P	L	P	G	P	P
Trisodium Phosphate Solutions	L	G	P	G	G	G
Turpentine	G	G	L	G	P	P
Ucon (Hydraulic fluid-water glycol base)	G	G	L	G	G	L
Varnish	G	G	G	G	P	L
Vinegar (6)	L	G	L	G	G	G
Water (to 135°F) (6)	G	G	G	G	G	G
Water (above 135°F) (6)	P	G	P	G	G	G
Water Glycols (to 135°F)	L	G	L	G	G	-
Water Glycols (above 135°F)	P	P	P	G	G	-
Water in oil Emulsions (to 135°F)	G	G	L	G	P	-
Water in oil Emulsions (above 135°F)	P	G	P	G	P	-
Whiskey, Wines (6)	G	G	L	G	G	G
Wood Oils	G	G	L	G	P	L
Xylene	L	G	P	G	P	P
Zinc Chloride	G	G	G	G	G	G

Rating Code - pg. A-21

Notes:

The Fluid Compatibility Guides are simplified rating tabulations based on immersion tests at 75°F. Higher temperatures tend to reduce ratings. Since final selection depends on pressure, fluid and ambient temperature and other factors not known to Parker Hannifin Co., no performance guarantee is expressed or implied. Ratings do not imply compliance with specialized codes such as FDA, NSF, AGA or UL and do not cover possible fluid discoloration, taste or odor effects. For conveying foodstuffs, use FDA sanctioned materials and for potable water, use NSF listed materials. For chemicals not listed, or for advice on particular applications, please consult Product Engineering, Parflex Div., Ravenna, Ohio.

- (2) Hose applications for these fluids must take into account legal and insurance regulations. This does not imply AGA or UL compliance.
- (3) Satisfactory at some concentrations and temperatures, unsatisfactory in others.
- (4) For high pressure gases, the cover should be pinpricked and the pressure must not be released quickly. Chain or restrain the hose to prevent personal injury in the event of damage or failure.
- (5) Chemical compatibility does not imply low permeation rates. Consult the Parker factory for a suggestion for your specific requirement.
- (6) Does not imply NSF or FDA compliance.
- (7) Chemical compatibility does not imply acceptability for use in airless paint spray applications. These applications require a special conductive hose.
- (8) Fluoropolymers are chemically compatible with Anhydrous Ammonia. However, extreme caution must be used in dealing with Anhydrous Ammonia since it can cause severe injuries such as blindness and/or chemical burns.

Volumetric Expansion of Hose

at Maximum Working Pressure

Hydraulic hoses expand under pressure. On some applications, customers can use the differences in expansion between hoses to tune systems for better performance or even noise reduction. Parflex has tested a select list of hoses and determined the rate of expansion in cubic centimeters per foot of hose (cc/ft). To calculate the volumetric expansion of a hose, substitute the desired pressure into the "X" values in the appropriate equation. For other hoses, please contact the division.

Volumetric Expansion (VE) of Hose

Hose Part Number	VE at Max. Working Pressure		Equation for Volumetric Expansion	
	psi	cc/ft	Y=cc/ft	X=psi
510C-3	3250	2.33	Y=0.0007X+0.0581	
510C-4	3000	2.71	Y=0.0009X+0.0059	
510C-5	2500	3.41	Y=0.0013X+0.1647	
510C-6	2250	4.32	Y=0.0019X+0.0471	
510C-8	2250	7.36	Y=0.0032X+0.1637	
510C-12	1250	8.99	Y = 0.00745x - 0.29910	
510C-16	1000	15.33	Y = 0.01573x - 0.44928	
518C-3	3250	2.33	Y=0.0007X+0.0581	
518C-4	3150	2.71	Y=0.0009X+0.0059	
518C-5	3150	3.41	Y=0.0013X+0.1647	
518C-6	3000	4.32	Y=0.0019X+0.0471	
518C-8	3000	7.36	Y=0.0032X+0.1637	
518C-12	1660	8.99	Y = 0.00745x - 0.29910	
518C-16	1330	15.33	Y = 0.01573x - 0.44928	
520N-3/528N-3	5000	1.13	Y = 0.0002x + 0.1621	
520N-4/528N-4	5000	2.05	Y = 0.00031x + 0.47589	
520N-5/528N-5	4500	2.63	Y = 0.00048x + 0.48415	
520N-6/528N-6	4000	2.87	Y = 0.00053x + 0.75151	
520N-8/528N-8	3500	3.64	Y = 0.00086x + 0.64994	
53DM-4	3000	1.9	Y = 0.00062x + 0.02373	
53DM-6/538DM-6	3000	3.19	Y = 0.0010x + 0.0647	
53DM-8	3000	4.68	Y = 0.0016x + 0.0384	
53DM-10	3000	9.82	Y = 0.0033x - 0.2254	
540N-2	3000	1.11	Y = 0.00036x + 0.04607	
540N-3	3000	1.75	Y = 0.00057x + 0.03059	
540N-4	2750	2.33	Y = 0.00079x + 0.14354	
540N-5	2500	3.46	Y = 0.00124x + 0.31870	
540N-6	2250	4.06	Y = 0.00174x + 0.15045	
540N-8	2000	6.05	Y = 0.0030x + 0.0928	
540N-12	1250	10.26	Y = 0.0081x - 0.2671	
560TJ-3	3626	0.575	Y = 0.00017x + 0.00875	
560TJ-4	3263	0.757	Y = 0.0002x + 0.1172	
560TJ-5	3118	0.729	Y = 0.00021x + 0.09887	
560TJ-6	2750	1.33	Y = 0.0004x + 0.1918	
560TJ-8	2500	1.98	Y = 0.0007x + 0.2093	
560TJ-10	2000	3.04	Y = 0.0012x + 0.5704	
560TJ-12	1750	3.07	Y = 0.0015x + 0.4449	

Volumetric Expansion (VE) of Hose

Hose Part Number	VE at Max. Working Pressure		Equation for Volumetric Expansion	
	psi	cc/ft	Y=cc/ft	X=psi
575X-3	5000	1.69	Y = 0.0003x + 0.2119	
575X-4	5000	2.05	Y = 0.0003x + 0.5601	
520N-5/528N-5	4500	2.63	Y = 0.00048x + 0.48415	
520N-6/528N-6	4000	2.87	Y = 0.00053x + 0.75151	
520N-8/528N-8	3500	3.64	Y = 0.00086x + 0.64994	
53DM-4	3000	1.9	Y = 0.00062x + 0.02373	
520N-6/528N-6	4000	2.87	Y = 0.00053x + 0.75151	
520N-8/528N-8	3500	3.64	Y = 0.00086x + 0.64994	
53DM-4	3000	1.9	Y = 0.00062x + 0.02373	
575X-6	5000	2.71	Y = 0.0004x + 0.8412	
575XN-8	5000	4.59	Y = 0.00064x + 1.41795	
575X-12	5000	12.52	Y = 0.00192x + 2.92038	
575X-16	5000	16.81	Y = 0.0028x + 2.9560	
590TJ-4	5076	0.888	Y = 0.00016x + 0.09821	
590TJ-6	4061	1.87	Y = 0.00038x + 0.32317	
590TJ-8	3553	2.17	Y = 0.00049x + 0.43765	
590TJ-12	2500	4.2	Y = 0.0013x + 0.8216	
590TJ-16	2030	6.21	Y = 0.0026x + 1.0558	
D6R04 / D6RX04	3000	2.71	Y = 0.0009x + 0.0059	
D6R05	3000	1.28	Y = 0.0003x + 0.3834	
D6R06 / D6RX06	3000	1.28	Y = 0.0003x + 0.3834	
D6R08 / D6RX08	3000	2.88	Y = 0.00057x + 1.20744	
D6R10	3000	2.08	Y = 0.00061x + 0.23127	
D6R12	3000	5.53	Y = 0.00142x + 1.21743	
D6R16	3000	7.33	Y = 0.00205x + 1.24905	
H604	3000	1.8	Y = 0.00044x + 0.51607	
H605	3000	1.35	Y = 0.00036x + 0.26536	
H606	3000	2	Y = 0.0006x + 0.2892	
H608	3000	2.88	Y = 0.00057x + 1.20744	
H610	3000	2.08	Y = 0.00061x + 0.23127	
H612	3000	5.53	Y = 0.00142x + 1.21743	

The actual volumetric expansion achieved is influenced by multiple variables including fluid properties, hose routing and application temperature.

The volumetric expansion calculation is only a general guideline and must be verified by actual testing in the end-use application.

Example: Find the volumetric expansion of 560-8 hose at 2000 psi

- From the chart, the appropriate equation would be:
Y=0.0007x + 0.2093
- Substituting: Y=0.0007* (2000) + 0.2093
- Volumetric expansion "Y" = 1.60 cc/ft @ 2000 psi

No performance warranty in design is expressed or implied by this calculation. Parker recommends that the user review and understand all the precautions listed in the Parker Safety Guide for Selecting and Using Hose, Fittings and Accessories, bulletin BUL. 4400-B.1.

Selection, Installation & Maintenance

Right/Wrong



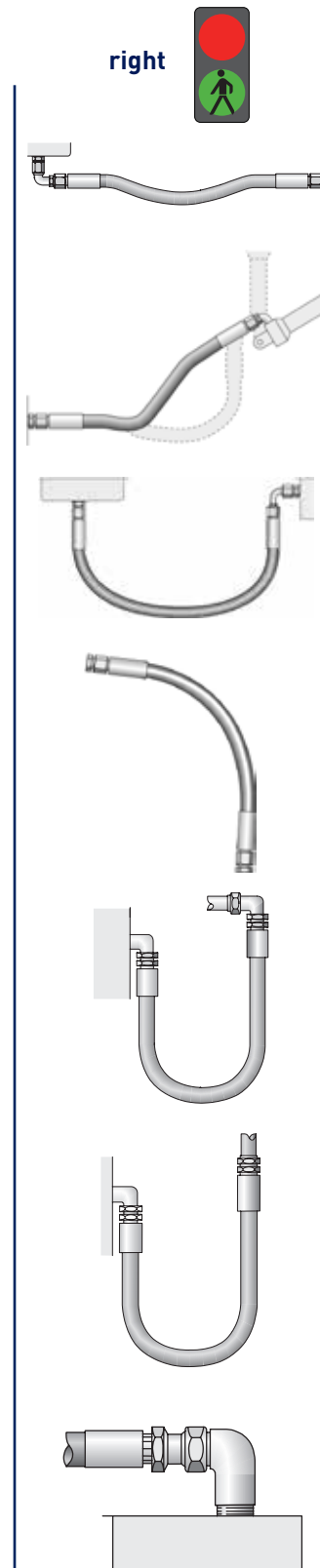

- The routing of the hose assembly and the environment in which the hose assembly operates directly influence the service life of the hose assembly. The following diagrams indicate the correct routing of hose assemblies that will maximize its service life and assure a safe working functionality.
- When hose installation is straight, there must be enough slack in the hose to allow for changes in length that occur when pressure is applied. When pressurized, hose that is too short may pull loose from its hose fittings or stress the hose fitting connections, causing premature metallic or seal failures.
- The hose length must be determined so that the hose assembly has enough slack to allow the system components to move or vibrate without creating tension in the hose.
- However, do not allow too much slack and therefore introduce the risk of the hose snagging on other equipment or rubbing on other components.
- Mechanical straining of the hoses needs to be avoided, so the hose must not be bent below its minimum bend radius or twisted during installation. The minimum bending radii for each hose is stated in the hose tables in the catalogue.
- The plane of movement must also be considered and the hose routing selected accordingly.
- Hose routing also plays an important role on the selection of the hose fittings, as the correct fittings can avoid straining the hoses, unnecessary hose length or multiple threaded joints.
- Correct clamping (holding/supporting) of the hose should be exercised to securely route the hose or to avoid the hose contacting surfaces that will cause the hose damage. It is however, vital that the hose be allowed to keep its functionality as a "flexible-pipe" and not be restricted from changing in length when under pressure.

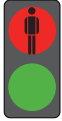
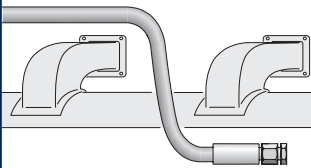

Selection, Installation & Maintenance

Right/Wrong

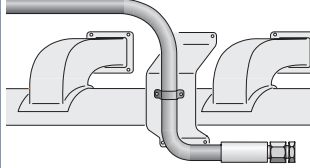
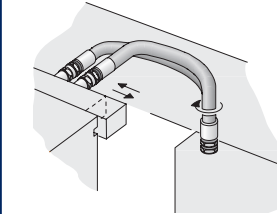
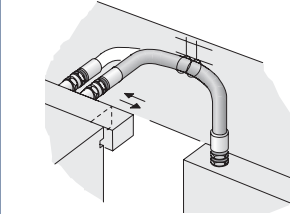
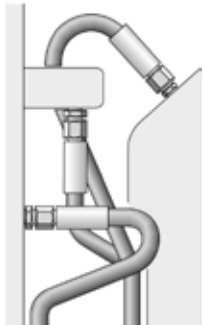
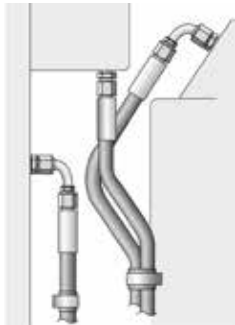
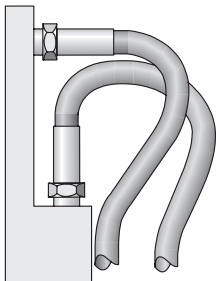
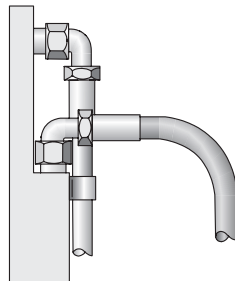
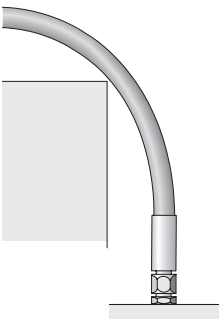
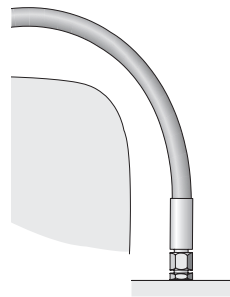
<p>wrong </p> 	<ul style="list-style-type: none"> It should also be noted that hoses for high- and low-pressure lines shall not be crossed or clamped together, as the difference in changes in length could wear the hose covers. 	<p>right </p> 
<p>Tubing</p> 	<ul style="list-style-type: none"> Hose should not be bent in more than one plane. If hose follows a compound bend, it shall be coupled into separate segments or clamped into segments that each flex in only one plane. 	
<p>Coiled Air Hose & Fittings</p>	<ul style="list-style-type: none"> Hoses should be kept away from hot parts as high ambient temperatures shorten hose life. Protective insulation may need to be used in unusually high ambient temperature areas. 	
<p>Transportation</p> 	<ul style="list-style-type: none"> While the importance of the functionality is primary, the aesthetics and practicality of the installation should also be considered in the design. 	
<p>Fittings</p> 	<p>Abrasive Influences</p> <p>In general care should be taken so that the hose is not exposed to direct surface contact that will cause abrasive wearing of the outer cover (either hose to object or hose to hose contact). If however, the application is such that this cannot be avoided, either a hose with a higher abrasion resistant hose cover or a protective sleeve need to be used.</p>	
<p>Tooling, Equipment & Accessories</p> 		
<p>General Technical</p>		

Nomenclature - Thermoplastic Hose

Parflex



Product Family	Hose			Fitting Configuration*	Connection Size 1	Connection Size 2
F - Parkrimp (i.e. 56 series)	1035HT	560TJ	HFSR	01 - Male Pipe Thread (with hex) - NPTF	-2 - 1/8	-2 - 1/8
	510C	563TJ	HFS2R	02 - Female Pipe Thread - NPT	-3 - 3/16	-3 - 3/16
	510D	56DH	HTB/HTBR	03 - Male SAE (JIC) 37° Flare	-4 - 1/4	-4 - 1/4
A - Factory Crimp	518D	580N	MSH	05 - Male Straight Thread w/ O-Ring	-5 - 5/16	-5 - 5/16
	520N	588N	MSXL	06 - Female SAE (JIC) 37° Swivel	-6 - 3/8	-6 - 3/8
	527BA	590TJ	PTH	07 - Female Pipe Swivel	-8 - 1/2	-8 - 1/2
	528N	594TJ	R6	13 - Male Pipe Swivel - NPTF	-10 - 5/8	-10 - 5/8
R - Field Attachable (i.e. 51 or 51R series)	53DM/538DM	5CNG	S5N	37 - Female SAE (JIC) 37° Swivel - 45° Elbow	-12 - 3/4	-12 - 3/4
	540N	83FR	S6	39 - Female SAE (JIC) 37° Swivel - 90° Elbow	-16 - 1	-16 - 1
	540P	B9	S9	41 - Female SAE (JIC) 37° Swivel - 90° Long Elbow	-20 - 1-1/4	-20 - 1-1/4
	55LT	D6R/D6RX		JC - Female Seal-Lok™ (ORFS) Swivel Short		
	563LT	H6		FU - Female JIS/BSP 30° Flare Swivel		
				MU - Metric Female JIS/BSP 30° Flare Swivel		
			JO - Male Seal-Lok™ (ORFS) Rigid Strt w/O-Ring			
			GU - Female JIS/BSP Parallel Pipe Swivel (60° Cone)			
			JS - Female Seal-Lok™ (ORFS) Swivel			
			J7 - Female Seal-Lok™ (ORFS) Swivel - 45° Elbow			
			J9 - Female Seal-Lok™ (ORFS) Swivel - 90° Elbow			
			TU - Universal Tube Stub			
			AL - A-Lok® Compression			

Note: See pg. E-5 for detailed list of available fitting configurations. Please note that not all configurations are available in each fitting series.

Hose Size	Fitting Material	Overall Length	Displacement Angle
-2 - 1/8	**No Material	Expressed	Specified only if two
-3 - 3/16	Designation,	in	elbow fittings are
-4 - 1/4	Steel	inches	used to construct
-5 - 5/16			hose assembly.*
-6 - 3/8			
-8 - 1/2	C = Stainless	*Note:	
-10 - 5/8	Steel	Face Seal type	
-12 - 3/4		fittings are	
-16 - 1		measured from	
		sealing face.	

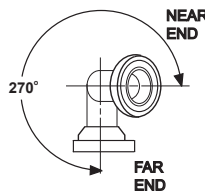

*Note:

- *Starting with either end as the far end, measure the angle clockwise to describe the displacement of the near end.

Example: F540N0639121212C-52-##

F540N0639121212C-52-## - Parkrimp Hose Style

F540N0639121212C-52-## - Hose Series

F540N0639121212C-52-## - Fitting Configuration

06 = Female SAE JIC 37° Swivel

39 = Female SAE JIC 37° Swivel - 90° Elbow

F540N0639121212C-52-## - Connection Size 1 - 12 = 3/4"

F540N0639121212C-52-## - Connection Size 2 - 12 = 3/4"

F540N0639121212C-52-## - Hose Size - 12 = 3/4"

F540N0639121212C-52-## - Fitting Material C= Stainless Steel

F540N0639121212C-52-## - Overall Hose Length 52 inches

F540N0639121212C-52-## - Displacement Angle Not used

A Hose

B Tubing

C Coiled Air Hose & Fittings

D Transportation

E Fittings

F Tooling, Equipment & Accessories

G General Technical

Nomenclature - Fluoropolymer Hose

Series 919



Product Family	Hose		Fitting Configuration*	Connection Size 1	Connection Size 2	Hose Size
P - Permanent	919	929B	01 - Male Pipe Thread (with hex) - NPTF	-4 - 1/4	-4 - 1/4	-4 - 1/4
	919J	919BJ	02 - Female Pipe Thread - NPT	-5 - 5/16	-5 - 5/16	-5 - 5/16
Crimp (i.e. 91N series)	919U	-	03 - Male SAE (JIC) 37° Flare	-6 - 3/8	-6 - 3/8	-6 - 3/8
	929	929B	05 - Male Straight Thread w/ O-Ring	-8 - 1/2	-8 - 1/2	-8 - 1/2
	939	939B	06 - Female SAE (JIC) 37° Swivel	-10 - 5/8	-10 - 5/8	-10 - 5/8
R - Field Attachable (i.e. 90 series)	944B	955B	07 - Female Pipe Swivel	-12 - 3/4	-12 - 3/4	-12 - 3/4
			13 - Male Pipe Swivel - NPTF	-16 - 1	-16 - 1	-16 - 1
Factory Crimp (i.e. 94 series)			37 - Female SAE (JIC) 37° Swivel - 45° Elbow	-20 - 1-1/4	-20 - 1-1/4	-20 - 1-1/4
			39 - Female SAE (JIC) 37° Swivel - 90° Elbow	-24 - 1-1/2	-24 - 1-1/2	-24 - 1-1/2
			41 - Female SAE (JIC) 37° Swivel - 90° Long Elbow	-32 - 2	-32 - 2	-32 - 2
			JC - Female Seal-Lok™ (ORFS) Swivel Short			
			FU - Female JIS/BSP 30° Flare Swivel			
			MU - Metric Female JIS/BSP 30° Flare Swivel			
		JO - Male Seal-Lok™ (ORFS) Rigid Strt w/O-Ring				
		GU - Female JIS/BSP Parallel Pipe Swivel (60° Cone)				
		JS - Female Seal-Lok™ (ORFS) Swivel				
		J7 - Female Seal-Lok™ (ORFS) Swivel - 45° Elbow				
		J9 - Female Seal-Lok™ (ORFS) Swivel - 90° Elbow				
		TU - Universal Tube Stub				
		AL - A-Lok® Compression				

Note: See pg. E-5 for detailed list of available fitting configurations. Please note that not all configurations are available in each fitting series.

Fitting Material	Overall Length	Displacement Angle
**No Material Designation, Steel	Expressed in inches	Specified only if two elbow fittings are used to construct hose assembly.*

- C = Stainless Steel
- B = Brass (91N)
- S = All Steel (91N)

OAL measured from centerline of fitting seat if elbow fittings are used.

Note: Face Seal type fittings are measured from sealing face.

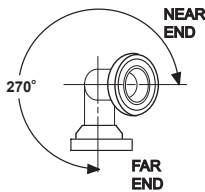

*Note:
 • *Starting with either end as the far end, measure the angle clockwise to describe the displacement of the near end.

Example: P9190639060606C-30-##

P9190639060606C-30-## – Permanent Crimp Hose Style
 P9190639060606C-30-## – Hose Series
 P9190639060606C-30-## – Fitting Configuration
 06 = Female SAE JIC 37° Swivel
 39 = Female SAE JIC 37° Swivel - 90° Elbow
 P9190639060606C-30-## – Connection Size 1 -6 = 3/8"
 P9190639060606C-30-## – Connection Size 2 -6 = 3/8"
 P9190639060606C-30-## – Hose Size -6 = 3/8"
 P9190639060606C-30-## – Fitting Material C= Stainless Steel
 P9190639060606C-30-## – Overall Hose Length 30 inches
 P9190639060606C-30-## – Displacement Angle Not used

Nomenclature - Fluoropolymer Hose

Series PAGE



Size Code	Hose Code		Fitting Code							
	hose	code								
1/4"	04		Industrial Thread	Male Pipe NPT Hex	03	JIC Female Swivel	30	Female NPSH	27	
5/16"	05	CWV		Female Pipe NPT Hex	06	Male JIC 37°	31	Female ORFS Swivel	80	
3/8"	06	NCB		Male Pipe NPT Step Down	13	JIC Female Step Up	32	Male ORFS	81	
1/2"	08	NCW		Male Pipe NPT Step Up	23	Male Union	33	Male O-Ring Boss	86	
5/8"	10	PCB		Male Union Step Up	34	Female Union	36	Male JIC 37°	31	
3/4"	12	SCB		Male Union Step Down	35					
7/8"	14	SCBV								
1"	16	SCW		Flanges	Flange Retainer	05	Flare-Seal® Flange Retainer	32		
1-1/4"	20	SCWW		Cam Lock	Female Cam Lock w/Locking Handles	07	Male Cam Lock	32		
1-1/2"	24	STB								
2"	32	STW								
2-1/2"	40		Sanitary	Sanitary Tri Clamp	40	Sanitary 3-Step Up	4C	I-Line Male	48	
3"	48			Sanitary Tri Clamp 45°	4K	Sanitary Flare Seal™	4F	I-Line Female	49	
4"	64			Sanitary Tri Clamp 90°	4L	Sanitary Mini	42	Bevel Seat Female	45	
				Sanitary 1-Step Up	4A	Sanitary Mini Step Up	43	Bevel Seat Male	46	
				Sanitary 2-Step Up	4B					
			Tube and Vacuum	PAGElok™ Tube Adapter	38	PAGElok™ Tube Compression Fitting	39			
			Special Ends	Standard Cuffed Ends	90	Non Standard Fitting	4C			

Fitting Code	
304 Stainless (SS 304)	4
316 Stainless (SS 316)	6
316 Stainless (SS 15Ra) Electropolished to 15Ra	E
Steel	C
PFA Encapsulated	T
Hastelloy	H
Monel	M

Overall Length	
Expressed In inches	
0010 = 10 inches	
0120 = 120 inches	

Flange Material	
None	0
Carbon Steel Epoxy Coated	D
304SS	4
316SS	6
Kynar	K
Polypropylene	P
Non-Standard	X

Accessory Code	
None	
Spring Guard	S
Armour Guard	A
End Bend Restrictors	E
Fire Sleeve	F
Rubber Sleeve	H
FEP Heat Shrink	T
Polyolefin Heat Shrink	P
Silicone Sleeve	M
Vacuum Spring Wire	W
Specials	X

Example: 32J03C13C0-0120-A

32J03C13C0-0120-A – Hose Size -32 = 2 inches
 32J03C13C0-0120-A – Hose Code = SCWW Series
 32J03C13C0-0120-A – Fitting Configuration End 1
 03 = Male Pipe NPT Hex
 32J03C13C0-0120-A – Fitting Material End 1 C = Steel
 32J03C13C0-0120-A – Fitting Configuration End 2
 13 = Male Pipe NPT Step Down
 32J03C13C0-0120-A – Fitting Material End 2 C = Steel
 32J03C13C0-0120-A – Overall Hose Length 0120 = 120 inches
 32J03C13C0-0120-A* – Accessory Code A - Armour Guard

*Note: There are places for 2 characters. If number, refer to length; if letter, refer to accessories code
 Character 1 = Length in 1/8" increments
 Character 2 = Accessory code

The part numbering system shows the entire product line offered by the Parker PAGE International business unit. This catalog section only displays a few common hoses.

D6R/D6RX – Hybrid® SAE 100R17 Hydraulic Hose

Copolyester Core Tube

Compact hose construction for bend radius less than half of conventional SAE hoses.



Features

- Up to 40% lighter than comparable rubber hoses
- Wide range of fluid compatibility
- Bend radius less than half of conventional SAE 100R1AT and 100R2 hoses
- Low force to flex
- 3,000 psi constant working pressure

Construction

- Tube: Copolyester
- Reinforcement: One or two high tensile steel wire braids
- Cover: Smooth Synthetic Rubber

Operating Parameters

- Temperature Range:
 - Petroleum based hydraulic fluids and lubricating oils within a temperature range -40°F (-40°C) to 250°F (121°C)
 - Synthetic, synthetic blend, water, and water/oil emulsion hydraulic fluids limited to 185°F (85°C)
 - Water/glycol hydraulic fluids limited to 135°F (57°C)
- Vacuum Rating: 28 inch Hg
- Change in length at Max. Working Pressure: +2% to -4%
- Min. Burst Pressure is 4x Max. Working Pressure at 73°F (23°C)

Compliance

- Exceeds SAE J517 100R17
- MSHA compliant cover

Fittings

- 56 Series – pg. E-33
- For most Parker products, Crimp Die Selection charts are found online at www.parker.com/crimpsource
- Access instructions are on pg. G-3

Notes

- * X designates a continuous, long length reel (ie D6RX04)
- **Two wire braid
- Non-perforated cover

Color

- ● Black

Series D6R/D6RX

[Visit the webpage](#)

Part Number	Nominal I.D.		Maximum O.D.		Maximum Working Pressure		Minimum Bend Radius		Weight		Permanent Fitting Series
	inch	mm	inch	mm	psi	MPa	inch	mm	lbs./ft.	kg/mtr	
D6R04	1/4	6.3	0.46	11.7	3,045	21.0	1-1/2	38.1	0.10	0.14	56
D6RX04*											
D6R05	5/16	8	0.52	13.2	3,045	21.0	1-3/4	44.5	0.12	0.18	56
D6RX06											
D6R06	3/8	10	0.61	15.5	3,045	21.0	2	50.8	0.17	0.25	56
D6RX06											
D6R08	1/2	12.5	0.78	19.9	3,045	21.0	3	76.2	0.26	0.38	56
D6RX08*											
D6R10**	5/8	16	0.97	24.7	3,045	21.0	3-1/2	88.9	0.43	0.64	56
D6R12**	3/4	19	1.14	28.9	3,045	21.0	4-1/4	108.0	0.71	1.06	56
D6R16**	1	25	1.45	36.8	3,045	21.0	6	150.0	0.91	1.36	56



WARNING

This product can expose you to chemicals including Antimony Oxide (Antimony Trioxide), which is known to the State of California to cause cancer, and 2-Imidazolidinethione, which is known to the State of California to cause birth defects or other reproductive harm. For more information go to www.P65Warnings.ca.gov.

HFSR Hybrid® SAE 100R1AT Hydraulic Hose

Copolyester Core Tube

Compact O.D. without reduced flow and up to 40% lighter than comparable rubber hoses.



Features

- Up to 40% lighter than comparable rubber hoses
- Wide range of fluid compatibility
- Bend radius less than half of conventional SAE 100R1AT and 100R2 hoses
- Low force to flex

Construction

- Tube: Copolyester
- Reinforcement: High tensile steel wire braid
- Cover: Smooth Synthetic Rubber

Operating Parameters

- Temperature Range:
 - Petroleum based hydraulic fluids and lubricating oils within a temperature range -40°F (-40°C) to 250°F (121°C)
 - Synthetic, synthetic blend, water, and water/oil emulsion hydraulic fluids limited to 185°F (85°C)
 - Water/glycol hydraulic fluids limited to 135°F (57°C)
- Vacuum Rating: 28 inch Hg
- Change in length at Max. Working Pressure: +2% to -4%
- Min. Burst Pressure is 4x Max. Working Pressure at 73°F (23°C)

Compliance

- Meets/Exceeds SAE J517 100R1AT
- MSHA compliant cover

Fittings

- 56 Series – pg. E-33
- For most Parker products, Crimp Die Selection charts are found online at www.parker.com/crimpsource
- Access instructions are on pg. G-3

Notes

- Non-perforated cover

Color

- ● Black

Series HFSR

[Visit the webpage](#)

Part Number	Nominal I.D.		Maximum O.D.		Maximum Working Pressure		Minimum Bend Radius		Weight		Permanent Fitting Series
	inch	mm	inch	mm	psi	MPa	inch	mm	lbs./ft.	kg/mtr	
HFSR04	1/4	6.3	0.46	11.7	3,263	22.5	1-1/2	38.1	0.10	0.15	56
HFSR05	5/16	8	0.52	13.2	3,118	21.5	1-3/4	44.5	0.12	0.18	56
HFSR06	3/8	10	0.61	15.5	2,611	18.0	2	50.8	0.17	0.25	56
HFSR08	1/2	12.5	0.74	18.8	2,500	17.2	3	76.2	0.21	0.31	56
HFSR12	3/4	19	1.02	25.9	1,523	10.5	4-1/2	108.0	0.31	0.46	56
HFSR16	1	25	1.31	33.2	1,276	8.8	7-1/2	190.5	0.44	0.66	56



WARNING

This product can expose you to chemicals including Antimony Oxide [Antimony Trioxide], which is known to the State of California to cause cancer, and 2-Imidazolidinethione, which is known to the State of California to cause birth defects or other reproductive harm. For more information go to www.P65Warnings.ca.gov.

HFS2R – Hybrid® Hydraulic Hose

Copolyester Core Tube

Compact O.D. for easier change outs and up to 40% lighter than comparable rubber hose.



Features

- Up to 40% lighter than comparable rubber hoses
- Wide range of fluid compatibility
- Compact hose construction
- Bend radius less than half of conventional 100R2 hoses
- Low force to flex

Construction

- Tube: Copolyester
- Reinforcement: One or two high tensile steel wire braids
- Cover: Smooth Synthetic Rubber

Operating Parameters

- Temperature Range:
 - Petroleum based hydraulic fluids and lubricating oils within a temperature range -40°F (-40°C) to 212°F (100°C)
 - Synthetic, synthetic blend, water, and water/oil emulsion hydraulic fluids limited to 185°F (85°C)
 - Water/glycol hydraulic fluids limited to 135°F (57°C)
- Vacuum Rating: 28 inch Hg
- Change in length at Max. Working Pressure: +2% to -4%
- Min. Burst Pressure is 4x Max. Working Pressure at 73°F (23°C)

Compliance

- MSHA compliant cover

Fittings

- 56 Series – pg. E-33
- For most Parker products, Crimp Die Selection charts are found online at www.parker.com/crimpsource
- Access instructions are on pg. G-3

Notes

- *Two wire braid
- Non-perforated cover

Color

- ● Black

Series HFS2R

[Visit the webpage](#)

Part Number	Nominal I.D.		Maximum O.D.		Maximum Working Pressure		Minimum Bend Radius		Weight		Permanent Fitting Series
	inch	mm	inch	mm	psi	MPa	inch	mm	lbs./ft.	kg/mtr	
HFS2R04*	1/4	6.3	0.54	13.7	5,076	35.0	2	50.0	0.20	0.29	56
HFS2R06	3/8	10	0.64	16.3	4,061	28.0	2-1/2	63.5	0.20	0.30	56
HFS2R08	1/2	12.5	0.78	19.9	3,553	24.5	3-1/2	88.9	0.26	0.38	56
HFS2R10	5/8	16	0.93	23.6	2,784	19.2	4	100.0	0.34	0.50	56
HFS2R12	3/4	19	1.07	27.2	2,277	15.7	4-3/4	120.0	0.41	0.60	56
HFS2R16*	1	25	1.40	35.6	2,030	14.0	6	150.0	0.73	1.08	56



WARNING

This product can expose you to chemicals including Antimony Oxide (Antimony Trioxide), which is known to the State of California to cause cancer, and 2-Imidazolidinethione, which is known to the State of California to cause birth defects or other reproductive harm. For more information go to www.P65Warnings.ca.gov.

H6 – Low Temperature SAE 100R17 Hydraulic Hose

Copolyester Core Tube

Largest temperature range in a medium pressure hydraulic hose.

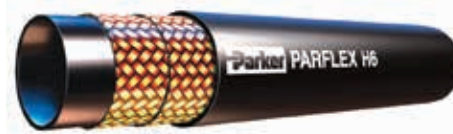

Features

- Largest temperature range in a medium pressure hydraulic hose
- Low length change under pressure
- Ideal for over-the-sheave boom applications

Construction

- Tube: Copolyester
- Reinforcement: One or two high tensile steel wire braids
- Cover: Abrasion resistant copolyester

Operating Parameters

- Temperature Range:
 - ♦ Petroleum based hydraulic fluids and lubricating oils within a temperature range:
 - H604 to H608 -70°F (-57°C) to 250°F (121°C)
 - H610 to H612 -50°F (-45°C) to 250°F (121°C)
 - ♦ Synthetic, synthetic blend, water, and water/oil emulsion hydraulic fluids limited to 135°F (57°C)
- Vacuum Rating: 28 inch Hg
- Change in length at Max. Working Pressure: +2% to -4%
- Min. Burst Pressure is 4x Max. Working Pressure at 73°F (23°C)

Compliance

- Meets/Exceeds SAE J517 100R17 performance

Fittings

- 56 Series – pg. E-33 HY Series - Fittings available from Parker Hose Products Division
- For most Parker products, Crimp Die Selection charts are found online at www.parker.com/crimpsource
- Access instructions are on pg. G-3

Notes

- *Two wire braid
- Twin line hose available
- Preformed assemblies
- Non-perforated cover

Color

- ● Black

Series H6

[Visit the webpage](#)

Part Number	Nominal I.D.		Maximum O.D.		Maximum Working Pressure		Minimum Bend Radius		Weight		Permanent Fitting Series
	inch	mm	inch	mm	psi	MPa	inch	mm	lbs./ft.	kg/mtr	
H604	1/4	6.3	0.49	12.5	3,045	21.0	2	50.0	0.11	0.16	56
H606	3/8	10	0.65	16.4	3,045	21.0	2-1/2	63.5	0.19	0.28	56
H608	1/2	12.5	0.78	19.8	3,045	21.0	3-1/2	88.9	0.25	0.38	56
H610*	5/8	16	1.00	25.3	3,045	21.0	4	100.0	0.48	0.71	HY
H612*	3/4	19	1.17	29.6	3,045	21.0	4-3/4	120.0	0.67	1.00	HY



WARNING

This product can expose you to chemicals including Antimony Oxide [Antimony Trioxide], which is known to the State of California to cause cancer, and 2-Imidazolidinethione, which is known to the State of California to cause birth defects or other reproductive harm. For more information go to www.P65Warnings.ca.gov.

R6 – Abrasion King, SAE 100R17 Hydraulic Hose

Copolyester Core Tube

Low temperature and abrasion resistant fabric cover.



Features

- Light weight
- Excellent flexibility
- Excellent abrasion resistance
- Blue plait provides hose identification

Construction

- Tube: Copolyester
- Reinforcement: One or two high tensile steel wire braids
- Cover: Abrasion-resistant Nylon Fabric

Operating Parameters

- Temperature Range:
 - ♦ Petroleum based hydraulic fluids and lubricating oils within a temperature range:
 - R604 to R610 -70°F (-57°C) to 250°F (121°C)
 - R612 -50°F (-45°C) to 212°F (100°C)
 - ♦ Synthetic, synthetic blend, water, and water/oil emulsion hydraulic fluids limited to 135°F (57°C)
- Vacuum Rating: 28 inch Hg
- Change in length at Max. Working Pressure: +2% to -4%
- Min. Burst Pressure is 4x Max. Working Pressure at 73°F (23°C)

Compliance

- Meets/Exceeds SAE J517 100R17 performance

Fittings

- HY Series - Fittings available from Parker Hose Products Division
- For most Parker products, Crimp Die Selection charts are found online at www.parker.com/crimpsource
- Access instructions are on pg. G-3

Notes

- *Two wire braid
- Non-perforated cover

Color

- ● Black

Series R6

[Visit the webpage](#)

Part Number	Nominal I.D.		Maximum O.D.		Maximum Working Pressure		Minimum Bend Radius		Weight		Permanent Fitting Series
	inch	mm	inch	mm	psi	MPa	inch	mm	lbs./ft.	kg/mtr	
R604	1/4	6.3	0.53	13.5	3000	20.7	2	50.8	0.11	0.16	HY
R606	3/8	10	0.69	17.5	3000	20.7	2-1/2	63.5	0.20	0.30	HY
R608	1/2	12.5	0.84	21.3	3000	20.7	3-1/2	88.9	0.27	0.40	HY
R610*	5/8	16	1.09	27.7	3000	20.7	4	102.0	0.51	0.76	HY
R612*	3/4	19	1.24	31.5	3000	20.7	4-3/4	120.7	0.71	1.06	HY



WARNING

This product can expose you to chemicals including Antimony Oxide (Antimony Trioxide), which is known to the State of California to cause cancer, and 2-Imidazolidinethione, which is known to the State of California to cause birth defects or other reproductive harm. For more information go to www.P65Warnings.ca.gov.

HTBR – Eliminator® Hybrid® Hydraulic Hose

Copolyester Core Tube

Four-spiral wire hose performance in a high tensile two-wire braid construction.



Features

- Four-spiral wire hose performance in a high tensile two-wire construction
- Ideal for applications typically reserved for spiral wire reinforced hoses
- Excellent flexibility
- Compact design

Construction

- Tube: Copolyester
- Reinforcement: Two high tensile steel wire braids
- Cover: Smooth Synthetic Rubber

Operating Parameters

- Temperature Range:
 - Petroleum based hydraulic fluids and lubricating oils within a temperature range -40°F (-40°C) to 212°F (100°C)
 - Synthetic, synthetic blend, water, and water/oil emulsion hydraulic fluids limited to 185°F (85°C) **HTB04 is limited to 135°F (57°C)
 - Water/glycol hydraulic fluids limited to 135°F (57°C)
- Vacuum Rating: 28 inch Hg
- Change in length at Max. Working Pressure: +2% to -4%
- Min. Burst Pressure is 4x Max. Working Pressure at 73°F (23°C)

Compliance

- MSHA compliant cover

Fittings

- HY Series 43 Series - Fittings available from Parker Hose Products Division
- For most Parker products, Crimp Die Selection charts are found online at www.parker.com/crimpsource
- Access instructions are on pg. G-3

Notes

- *HTB04, with HY-series fittings, must be assembled at the factory or by a Parflex approved facility
- Non-perforated cover

Color

- ● Black

Series HTBR

[Visit the webpage](#)

Part Number	Nominal I.D.		Maximum O.D.		Maximum Working Pressure		Minimum Bend Radius		Weight		Permanent Fitting Series
	inch	mm	inch	mm	psi	MPa	inch	mm	lbs./ft.	kg/mtr	
HTB04* **	1/4	6.3	0.62	15.7	7,000	48.3	4	102.0	0.27	0.40	HY
HTBR06	3/8	10	0.72	18.2	5,500	37.9	6	152.4	0.33	0.50	43
HTBR08	1/2	12.5	0.85	21.5	5,000	34.4	7	177.8	0.43	0.63	43
HTBR10	5/8	16	1.01	25.6	4,000	27.5	8	203.2	0.52	0.77	43
HTBR12	3/4	19	1.17	29.6	4,000	27.5	9-1/2	241.3	0.72	1.07	43
HTBR16	1	25	1.45	36.8	3,500	24.1	12	304.8	0.91	1.36	43



WARNING

This product can expose you to chemicals including Antimony Oxide [Antimony Trioxide], which is known to the State of California to cause cancer, and 2-Imidazolidinethione, which is known to the State of California to cause birth defects or other reproductive harm. For more information go to www.P65Warnings.ca.gov.

560TJ – TOUGHJACKET™ SAE 100R1AT Hydraulic Hose

Copolyester Core Tube

Twin or multi-line available.
General hydraulic hose.



Features

- Twin or multi-line available.
- Lighter and smaller than 100R1AT with longer lengths
- Fast response hose
- TOUGHJACKET Polyurethane cover for best abrasion resistance
- Low length change under pressure makes it an ideal solution for boom or cable track applications where long lengths are required
- Twin or multi-line hose/hose assembly production capabilities

Construction

- Tube: Copolyester
- Reinforcement: High Tensile Steel Wire Braid
- Cover: TOUGHJACKET Polyurethane

Operating Parameters

- Temperature Range:
 - Petroleum based hydraulic fluids and lubricating oils within a temperature range -40°F (-40°C) to 250°F (121°C)
 - Synthetic, synthetic blend, water, and water/oil emulsion hydraulic fluids limited to 185°F (85°C)
 - Water/glycol hydraulic fluids limited to 135°F (57°C)
- Vacuum Rating: 28 inch Hg
- Change in length at Max. Working Pressure: +/-2%
- Min. Burst Pressure is 4x Max. Working Pressure at 73°F (23°C)

Compliance

- Meets/Exceeds SAE J517 100R1AT performance
- MSHA compliant cover

Fittings

- 56 Series – pg. E-33
- For most Parker products, Crimp Die Selection charts are found online at www.parker.com/crimpsource
- Access instructions are on pg. G-3

Notes

- Non-perforated cover

Color

- ● Black



[Visit the webpage](#)

Series 560TJ

Part Number	Nominal I.D.		Maximum O.D.		Maximum Working Pressure		Minimum Bend Radius		Weight		Permanent Fitting Series
	inch	mm	inch	mm	psi	MPa	inch	mm	lbs./ft.	kg/mtr	
560TJ-3	3/16	5	0.39	9.9	3,626	25.0	3/4	19.1	0.01	0.11	56
560TJ-4	1/4	6.3	0.47	11.9	3,263	22.5	1-1/2	38.1	0.09	0.14	56
560TJ-5	5/16	8	0.53	13.4	3,118	21.5	1-3/4	44.5	0.11	0.16	56
560TJ-6	3/8	10	0.61	15.5	2,750	19.0	2	50.8	0.14	0.21	56
560TJ-8	1/2	12.5	0.75	19.0	2,500	17.2	3	76.2	0.19	0.29	56
560TJ-10	5/8	16	0.93	23.6	2,000	13.8	4	101.6	0.31	0.47	56
560TJ-12	3/4	19	1.04	26.4	1,750	12.1	4-1/4	107.9	0.28	0.42	56



WARNING

This product can expose you to chemicals including Antimony Oxide (Antimony Trioxide), which is known to the State of California to cause cancer, and 2-Imidazolidinethione, which is known to the State of California to cause birth defects or other reproductive harm. For more information go to www.P65Warnings.ca.gov.

563TJ – TOUGHJACKET™ SAE 100R17 Hydraulic Hose

Copolyester Core Tube - 3,000 psi

Lowest length change under pressure (+/- 1%).



Features

- Low length change under pressure makes it an ideal solution for boom or cable track applications where long lengths are required
- Up to 5% smaller O.D. than comparable 100R17 hoses
- Up to 42% lighter than comparable 100R17 hoses
- Excellent flexibility
- Consistent long-lengths
- TOUGHJACKET Polyurethane cover for best abrasion resistance
- Twin or multi-line hose/hose assembly production capabilities

Compliance

- Meets/Exceeds SAE J517 100R17 performance
- MSHA compliant cover

Construction

- Tube: Copolyester
- Reinforcement: One or two high tensile steel wire braids
- Cover: TOUGHJACKET Polyurethane

Fittings

- 56 Series – pg. E-33
- For most Parker products, Crimp Die Selection charts are found online at www.parker.com/crimpsource
- Access instructions are on pg. G-3

Operating Parameters

- Temperature Range:
 - Petroleum based hydraulic fluids and lubricating oils within a temperature range -40°F (-40°C) to 250°F (121°C)
 - Synthetic, synthetic blend, water, and water/oil emulsion hydraulic fluids limited to 185°F (85°C)
 - Water/glycol hydraulic fluids limited to 135°F (57°C)
- Vacuum Rating: 28 inch Hg
- Change in length at Max. Working Pressure:
 - 4 to -8: +/- 1%
 - 10 to -16: +/- 2%
- Min. Burst Pressure is 4x Max. Working Pressure at 73°F (23°C)

Notes

- Non-Perforated Cover
- For a lower temperature working hose -70°F (-57°C), see 563LT
- *Two wire braid

Color

- ● Black



Series 563TJ

[Visit the webpage](#)

Part Number	Nominal I.D.		Maximum O.D.		Maximum Working Pressure		Minimum Bend Radius		Weight		Permanent Fitting Series
	inch	mm	inch	mm	psi	MPa	inch	mm	lbs./ft.	kg/mtr	
563TJ-4	1/4	6.3	0.47	11.9	3,045	21.0	1-1/2	38.1	0.09	0.14	56
563TJ-6	3/8	10	0.64	16.3	3,045	21.0	2	50.8	0.19	0.29	56
563TJ-8	1/2	12.5	0.77	19.5	3,045	21.0	2-3/4	69.9	0.24	0.36	56
563TJ-10*	5/8	16	0.97	24.6	3,045	21.0	3-1/2	88.9	0.40	0.60	43
563TJ-12*	3/4	19	1.12	28.3	3,045	21.0	4-1/4	108.0	0.55	0.82	43
563TJ-16*	1	25	1.45	36.9	3,045	21.0	6	150.0	0.88	1.31	43



WARNING

This product can expose you to chemicals including Antimony Oxide [Antimony Trioxide], which is known to the State of California to cause cancer, and 2-Imidazolidinethione, which is known to the State of California to cause birth defects or other reproductive harm. For more information go to www.P65Warnings.ca.gov.

563LT – SAE 100R17 Low Temperature Hydraulic Hose

Copolyester Core Tube

Largest temperature range in a medium pressure hydraulic hose.



Features

- Lowest length change under pressure
- 3,000 psi constant pressure
- Ideal for over-the-sheave applications in cold temperature applications
- Twin or multi-line hose/hose assembly production capabilities

Construction

- Tube: Copolyester
- Reinforcement: High Tensile Steel Wire Braid
- Cover: Copolyester

Operating Parameters

- Temperature Range:
 - ♦ Petroleum based hydraulic fluids and lubricating oils within a temperature range:
 - 563LT-6 to 563LT-8 -70°F (-57°C) to 250°F (121°C)
 - 563LT-10 -50°F (-45°C) to 250°F (121°C)
 - ♦ Synthetic, synthetic blend, water, and water/oil emulsion hydraulic fluids limited to 185°F (85°C)
 - ♦ Water/glycol hydraulic fluids limited to 135°F (57°C)
- Vacuum Rating: 28 inch Hg
- Change in length at Max. Working Pressure:
 - 6 & 8: +/-1%
 - 10: +/-2%
- Min. Burst Pressure is 4x Max. Working Pressure at 73°F (23°C)

Compliance

- Meets/Exceeds SAE 100R17 performance

Fittings

- 56 Series – pg. E-33 43 Series - Fittings available from Parker Hose Products Division
- For most Parker products, Crimp Die Selection charts are found online at www.parker.com/crimpsource
- Access instructions are on pg. G-3

Notes

- *Two-wire braid
- Non-perforated cover

Color

- ● Black



[Visit the webpage](#)

Series 563LT

Part Number	Nominal I.D.		Maximum O.D.		Maximum Working Pressure		Minimum Bend Radius		Weight		Permanent Fitting Series
	inch	mm	inch	mm	psi	MPa	inch	mm	lbs./ft.	kg/mtr	
563LT-6	3/8	10	0.64	16.3	3,045	21.0	2	50.8	0.19	0.29	56
563LT-8	1/2	12.5	0.77	19.5	3,045	21.0	2-3/4	69.9	0.24	0.36	56
563LT-10*	5/8	16	0.97	24.6	3,045	21.0	3-1/2	88.9	0.40	0.60	43



WARNING

This product can expose you to chemicals including Antimony Oxide (Antimony Trioxide), which is known to the State of California to cause cancer, and 2-Imidazolidinethione, which is known to the State of California to cause birth defects or other reproductive harm. For more information go to www.P65Warnings.ca.gov.

590TJ – TOUGHJACKET™ Hydraulic Hose

Copolyester Core Tube

Two-wire strength, one wire construction for improved bend radius.



Features

- Two wire strength, one wire construction, improved bend radius results
- Low length change under pressure makes it an ideal solution for boom or cable track applications where long lengths are required
- Twin and multi-line available
- TOUGHJACKET Polyurethane cover for best abrasion resistance
- Twin or multi-line hose/hose assembly production capabilities

Construction

- Tube: Copolyester
- Reinforcement: One or two high tensile steel wire braids
- Cover: TOUGHJACKET Polyurethane

Operating Parameters

- Temperature Range:
 - Petroleum based hydraulic fluids and lubricating oils within a temperature range -40°F (-40°C) to 250°F (121°C)
 - Synthetic, synthetic blend, water, and water/oil emulsion hydraulic fluids limited to 185°F (85°C)
 - Water/glycol hydraulic fluids limited to 135°F (57°C)
- Vacuum Rating: 28 inch Hg
- Change in length at Max. Working Pressure: +/-2%
- Min. Burst Pressure is 4x Max. Working Pressure at 73°F (23°C)

Compliance

- MSHA compliant cover

Fittings

- 56 Series – pg. E-33 43 Series - Fittings available from Parker Hose Products Division
- For most Parker products, Crimp Die Selection charts are found online at www.parker.com/crimpsource
- Access instructions are on pg. G-3

Notes

- Non-perforated cover
- *Two wire braid

Color

- ● Black



[Visit the webpage](#)

Series 590TJ

Part Number	Nominal I.D.		Maximum O.D.		Maximum Working Pressure		Minimum Bend Radius		Weight		Permanent Fitting Series
	inch	mm	inch	mm	psi	MPa	inch	mm	lbs./ft.	kg/mtr	
590TJ-4	1/4	6.3	0.49	12.5	5,076	35.0	1-3/4	44.5	0.13	0.20	56
590TJ-6	3/8	10	0.64	16.3	4,061	28.0	2-1/4	57.2	0.19	0.29	56
590TJ-8	1/2	12.5	0.76	19.3	3,553	24.5	3-1/4	82.6	0.24	0.36	56
590TJ-12	3/4	19	1.08	27.3	2,500	17.2	4-3/4	120.0	0.39	0.58	43
590TJ-16*	1	25	1.42	36.0	2,030	14.0	6	150.0	0.71	1.06	43



WARNING

This product can expose you to chemicals including Antimony Oxide [Antimony Trioxide], which is known to the State of California to cause cancer, and 2-Imidazolidinethione, which is known to the State of California to cause birth defects or other reproductive harm. For more information go to www.P65Warnings.ca.gov.

594TJ – TOUGHJACKET™ SAE 100R19 Hydraulic Hose

Copolyester Core Tube - 4,000 psi

Four-spiral wire performance in a two-wire braid construction.



Features

- Four-spiral wire hose performance in a high tensile two-wire braid construction
- Excellent flexibility
- Consistent long-lengths
- TOUGHJACKET Polyurethane cover for best abrasion resistance
- Twin or multi-line hose/hose assembly production capabilities

Construction

- Tube: Copolyester
- Reinforcement: One or two high tensile steel wire braids
- Cover: TOUGHJACKET Polyurethane™

Operating Parameters

- Temperature Range:
 - Petroleum based hydraulic fluids and lubricating oils within a temperature range -40°F (-40°C) to 212°F (100°C)
 - Synthetic, synthetic blend, water, and water/oil emulsion hydraulic fluids limited to 185°F (85°C); **594TJ-10 is limited to 135°F (57°C)
 - Water/glycol hydraulic fluids limited to 135°F (57°C)
- Vacuum Rating: 28 inch Hg
- Change in length at Max. Working Pressure:
 - 4 to -10: +/- 2%
 - 12: +2% to -4%
- Min. Burst Pressure is 4x Max. Working Pressure at 73°F (23°C)

Compliance

- Meets/Exceeds SAE 100R19 performance
- MSHA compliant cover

Fittings

- 56 Series – pg. E-33 43 Series - Fittings available from Parker Hose Products Division
- For most Parker products, Crimp Die Selection charts are found online at www.parker.com/crimpsource
- Access instructions are on pg. G-3

Notes

- Non-perforated cover
- *Two wire braid

Color

- ● Black



[Visit the webpage](#)

Series 594TJ

Part Number	Nominal I.D.		Maximum O.D.		Maximum Working Pressure		Minimum Bend Radius		Weight		Permanent Fitting Series
	inch	mm	inch	mm	psi	MPa	inch	mm	lbs./ft.	kg/mtr	
594TJ-4	1/4	6.3	0.49	12.5	4,061	28.0	1-3/4	44.5	0.13	0.19	56
594TJ-6	3/8	10	0.64	16.3	4,061	28.0	2-1/2	63.5	0.19	0.28	56
594TJ-8*	1/2	12.5	0.85	21.5	4,061	28.0	3-1/2	88.9	0.39	0.59	43
594TJ-10* **	5/8	16	1.04	26.4	4,061	28.0	4	100.0	0.59	0.88	43
594TJ-12*	3/4	19	1.17	29.7	4,061	28.0	4-3/4	120.0	0.72	1.07	43



WARNING

This product can expose you to chemicals including Antimony Oxide (Antimony Trioxide), which is known to the State of California to cause cancer, and 2-Imidazolidinethione, which is known to the State of California to cause birth defects or other reproductive harm. For more information go to www.P65Warnings.ca.gov.

510C – SAE 100R7 Hydraulic Hose

Copolyester Core Tube

Largest size range for a medium pressure hydraulic hose.



Features

- Excellent abrasion resistance
- Excellent flexibility
- Low coefficient of friction cover
- Medium pressure service for permanent and field attachable fittings

Construction

- Tube: Copolyester
- Reinforcement: Fiber
- Cover: Polyurethane

Operating Parameters

- Temperature Range:
 - Petroleum based hydraulic fluids and lubricating oils within a temperature range -40°F (-40°C) to 212°F (100°C)
 - Synthetic, synthetic blend, water, and water/oil emulsion hydraulic fluids limited to 135°F (57°C)
- Vacuum Rating: 28 inch Hg
- Change in length at Max. Working Pressure: +/-2%
- Min. Burst Pressure is 4x Max. Working Pressure at 73°F (23°C)

Compliance

- Meets/Exceeds SAE J517 100R7 (excluding -2)
- MSHA compliant cover (excluding -4)
- DNV-GL Type Approved

Fittings

- 56 Series – pg. E-33 51 Series – pg. E-22
- For most Parker products, Crimp Die Selection charts are found online at www.parker.com/crimpsource
- Access instructions are on pg. G-3

Notes

- Perforated cover
- *3/16" and 1/4" working pressure reduced to 3,000 and 2,750 psi respectively when using field attachable fittings
- 51 Series field attachable fittings are not intended for use on hose that has previously been in service

Color

- ● Black

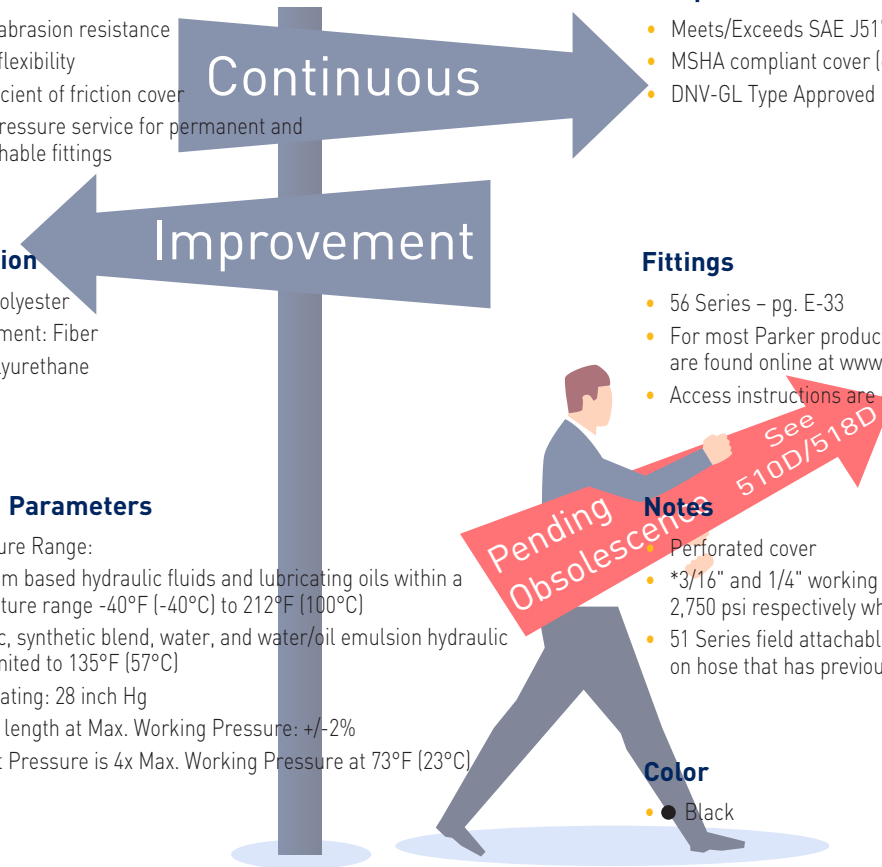

Series 510C

[Visit the webpage](#)

Part Number	Nominal I.D.		Maximum O.D.		Maximum Working Pressure		Minimum Bend Radius		Weight		Permanent Fitting Series	Permanent Fitting Series
	inch	mm	inch	mm	psi	MPa	inch	mm	lbs./ft.	kg/mtr		
510C-2	1/8	3.2	0.34	8.6	2,500	17.2	1/2	13.0	0.03	0.05	56	-
510C-3	3/16	5	0.43	10.9	3,250	22.4	3/4	19.0	0.05	0.07	56	51*
510C-4	1/4	6.3	0.47	11.9	3,000	20.7	1-1/2	38.0	0.05	0.08	56	51*
510C-5	5/16	8	0.57	14.5	2,500	17.2	1-3/4	44.0	0.08	0.11	56	51
510C-6	3/8	10	0.64	16.3	2,250	15.5	2	51.0	0.10	0.14	56	51
510C-8	1/2	12.5	0.81	20.6	2,250	15.5	3	76.0	0.15	0.22	56	51
510C-12	3/4	19	1.09	27.7	1,250	8.7	5	127.0	0.21	0.31	56	51
510C-16	1	25	1.32	33.5	1,000	6.9	8	203.0	0.27	0.40	56	51

WARNING



This product can expose you to chemicals including Nickel compounds, which is known to the State of California to cause cancer, and Toluene, which is known to the State of California to cause birth defects or other reproductive harm. For more information go to www.P65Warnings.ca.gov.

510D – SAE 100R7 Hydraulic Hose

Nylon Core Tube

Largest size selection
in a 100R7 hose.



Features

- Matte cover for low coefficient of friction
- Special order colors
- Twin or multi-line available
- Good chemical compatibility
- Approved for use with 51R-Series Field Attachable and Rapid Assembly connections

Construction

- Tube: Nylon: -3 to -12
Copolyester: -16
- Reinforcement: Fiber
- Cover: Polyurethane

Operating Parameters

- Temperature Range:
-40°F (-40°C) to 212°F (100°C)
 - Synthetic, synthetic blend, water, and water/oil emulsion hydraulic fluids limited to 135°F (57°C) {510D-16 only}
- Vacuum Rating: 28 inch Hg
- Change in length at Max. Working Pressure: +/-2%
- Min. Burst Pressure is 4x Max. Working Pressure at 73°F (23°C)

Compliance

- Meets/Exceeds SAE J517 100R7
- MSHA compliant cover
- DNV-GL Type Approved
- ISO 3949-R7-1

Fittings

- 56 Series – pg. E-33 51R Series - pg. E-24
- For most Parker products, Crimp Die Selection charts are found online at www.parker.com/crimpsource
- Access instructions are on pg. G-3

Notes

- Perforated cover
- For -2 hose needs, please reference HLBD02 on pg. A-62

Color

- ● Black

Series 510D

[Visit the webpage](#)

Part Number	Nominal I.D.		Maximum O.D.		Maximum Working Pressure		Minimum Bend Radius		Weight		Permanent Fitting Series	Field Attachable Fitting Series
	inch	mm	inch	mm	psi	MPa	inch	mm	lbs./ft.	kg/mtr		
510D-3	3/16	5	0.43	10.9	3,250	22.4	3/4	19.0	0.05	0.07	56	51R
510D-4	1/4	6.3	0.47	11.9	3,000	21.0	1-1/2	38.0	0.06	0.09	56	51R
510D-5	5/16	8	0.57	14.5	2,500	17.5	1-3/4	44.0	0.08	0.11	56	-
510D-6	3/8	10	0.64	16.3	2,250	15.8	2	51.0	0.10	0.14	56	51R
510D-8	1/2	12.5	0.81	20.6	2,250	15.8	3	76.0	0.15	0.22	56	51R
510D-10	5/8	16	0.98	24.9	2,750	19.2	6	152.0	0.21	0.31	56	-
510D-12	3/4	19	1.09	27.7	1,250	8.8	5	127.0	0.21	0.31	56	-
510D-16	1	25	1.32	33.5	1,000	7.0	8	203.0	0.27	0.40	56	-

WARNING



This product can expose you to chemicals including Nickel compounds, which is known to the State of California to cause cancer, and Toluene, which is known to the State of California to cause birth defects or other reproductive harm. For more information go to www.P65Warnings.ca.gov.

518C – SAE 100R7 Non-conductive Hose

Copolyester Core Tube

Hydraulic service where hydraulic circuit exposure and contact with high voltage may be encountered.



Features

- Twin or multi-line constructions available
- High density braid for maximum impulse life without loss of flexibility
- Low coefficient of friction cover

Construction

- Tube: Copolyester
- Reinforcement: Fiber
- Cover: Polyurethane

Operating Parameters

- Temperature Range:
 - Petroleum based hydraulic fluids and lubricating oils within a temperature range -40°F (-40°C) to 212°F (100°C)
 - Synthetic, synthetic blend, water, and water/oil emulsion hydraulic fluids limited to 135°F (57°C)
- Vacuum Rating: 28 inch Hg
- Change in length at Max. Working Pressure: +/-2%
- Min. Burst Pressure: (SAE requires 4:1 Design Factor)
 - 4:1 design factor required per SAE J517 100R7
 - 3:1 min design factor acceptable per ANSI A92.2

Compliance

- Meets SAE J517 for less than 50 micro-amps leakage under 75,000 volts per ft.
- Meets/Exceeds SAE J517 100R7 specifications and Electrical Standards except 518C-2 with respect to maximum working pressure
- DNV-GL Type Approved
- ANSI A92.2

Fittings

- 56 Series – pg. E-33 51 Series – pg. E-22
- For most Parker products, Crimp Die Selection charts are found online at www.parker.com/crimpsource
- Access instructions are on pg. G-3

Notes

- Non-perforated cover
- Lay lines on this hose will have both ANSI and SAE maximum working pressure listed. ANSI A92.2 "Vehicle Mounted Elevating and Rotating Aerial Devices"
- *3/16" and 1/4" working pressure reduced to 3,000 and 2,750 psi respectively when using field attachable fittings
- 51 Series field attachable fittings are not intended for use on hose that has previously been in service

Color

- Orange (non-conductive)

Series 518C

[Visit the webpage](#)

Part Number	Nominal I.D.		Maximum O.D.		ANSI A92.2 Maximum Working Pressure		SAE 100R7 Maximum Working Pressure		Minimum Bend Radius		Weight		Permanent Fitting Series	Field Attachable Fitting Series
	inch	mm	inch	mm	psi	MPa	psi	MPa	inch	mm	lbs./ft.	kg/mtr		
518C-2	1/8	3.2	0.34	8.6	3,150	21.7	2,500	17.2	1/2	13.0	0.03	0.05	56	-
518C-3	3/16	5	0.43	10.9	3,250	22.4	3,250	22.4	3/4	19.0	0.05	0.07	56	51*
518C-4	1/4	6.3	0.47	11.9	3,150	21.7	3,000	21.0	1-1/2	38.0	0.05	0.08	56	51*
518C-5	5/16	8	0.57	14.5	3,150	21.7	2,500	17.2	1-3/4	44.0	0.08	0.11	56	51
518C-6	3/8	10	0.64	16.3	3,000	20.7	2,250	15.5	2	51.0	0.10	0.14	56	51
518C-8	1/2	12.5	0.81	20.6	3,000	20.7	2,250	15.5	3	76.0	0.15	0.22	56	51
518C-12	3/4	19	1.09	27.7	1,660	11.4	1,250	8.7	5	127.0	0.21	0.31	56	51
518C-16	1	25	1.32	33.5	1,330	9.2	1,000	6.9	8	203.0	0.27	0.40	56	51

WARNING



This product can expose you to chemicals including Nickel compounds, which is known to the State of California to cause cancer, and Toluene, which is known to the State of California to cause birth defects or other reproductive harm. For more information go to www.P65Warnings.ca.gov.

518D – SAE 100R7 Non-conductive Hose

Nylon Core Tube

Nylon core for maximum resistance in hydraulic circuit applications where contact with high voltage may be encountered.



Features

- Nylon core for maximum resistance to permeable fluids
- -4 construction features:
 - Super high density braid resulting in compact braid O.D.
 - Heavier polyurethane jacket improving abrasion resistance and mutli/twin-line separation for bonded assemblies
- Low coefficient of friction cover
- Twin or multi-line constructions available
- Approved for use with 51R-Series Field Attachable and Rapid Assembly connections

Construction

- Tube: Nylon: -2 to -12
Copolyester: -16
- Reinforcement: Fiber
- Cover: Polyurethane

Operating Parameters

- Temperature Range:
 - 40°F (-40°C) to 212°F (100°C)
 - Synthetic, synthetic blend, water, and water/oil emulsion hydraulic fluids limited to 135°F (57°C) (518D-16 only)
- Vacuum Rating: 28 inch Hg
- Change in length at Max. Working Pressure: +/-2%
- Min. Burst Pressure: (SAE requires 4:1 Design Factor)
 - 4:1 design factor required per SAE J517 100R7
 - 3:1 min design factor acceptable per ANSI A92.2

Compliance

- Meets SAE J517 electrical standards (non-conductivity)
- Meets/Exceeds SAE J517 100R7
- DNV-GL Type Approved
- ANSI A92.2
- ISO 3949-R7-2

Fittings

- 56 Series – pg. E-33 51R Series – pg. E-24
- For most Parker products, Crimp Die Selection charts are found online at www.parker.com/crimpsource
- Access instructions are on pg. G-3

Notes

- Non-perforated cover
- Lay lines on this hose will have both ANSI and SAE maximum working pressure listed. ANSI A92.2 "Vehicle Mounted Elevating and Rotating Aerial Devices"

Color

- Orange (non-conductive)

Series 518D

[Visit the webpage](#)

Part Number	Nominal I.D.		Maximum O.D.		ANSI A92.2 Maximum Working Pressure		SAE 100R7 Maximum Working Pressure		Minimum Bend Radius		Weight		Permanent Fitting Series	Field Attachable Fitting Series
	inch	mm	inch	mm	psi	MPa	psi	MPa	inch	mm	lbs./ft.	kg/mtr		
518D-2	1/8	3.2	0.34	8.6	3,150	21.7	3,000	21.0	1/2	13.0	0.03	0.05	56	-
518D-3	3/16	5	0.43	10.9	3,250	22.4	3,250	22.4	3/4	19.0	0.05	0.07	56	51R
518D-4	1/4	6.3	0.47	11.9	3,150	21.7	3,000	21.0	1-1/2	38.0	0.06	0.09	56	51R
518D-5	5/16	8	0.57	14.5	3,150	21.7	2,500	17.5	1-3/4	44.0	0.08	0.11	56	-
518D-6	3/8	10	0.64	16.3	3,000	21.0	2,250	15.8	2	51.0	0.10	0.14	56	51R
518D-8	1/2	12.5	0.81	20.6	3,000	21.0	2,250	15.8	3	76.0	0.15	0.22	56	51R
518D-10	5/8	16	0.98	24.9	3,000	21.0	2,750	19.2	6	152.0	0.21	0.31	56	-
518D-12	3/4	19	1.09	27.7	1,660	11.4	1,250	8.8	5	127.0	0.21	0.31	56	-
518D-16	1	25	1.32	33.5	1,330	9.2	1,000	7.0	8	203.0	0.27	0.40	56	-



WARNING

This product can expose you to chemicals including Nickel compounds, which is known to the State of California to cause cancer, and Toluene, which is known to the State of California to cause birth defects or other reproductive harm. For more information go to www.P65Warnings.ca.gov.

520N/528N – SAE 100R8 Hydraulic Hose

Nylon Core Tube

Fast response with high density braid;
available in twin-line constructions.



Features

- Twin and multi-line available
- Fast response, lighter and smaller O.D. than 100R2 hose

Construction

- Tube: Nylon
- Reinforcement: Aramid Fiber
- Cover: Polyurethane

Operating Parameters

- Temperature Range:
-40°F (-40°C) to 212°F (100°C)
- Vacuum Rating: 28 inch Hg
- Change in length at Max. Working Pressure: +/-2%
- Min. Burst Pressure is 4x Max. Working Pressure at 73°F (23°C)

Compliance

- Meets/Exceeds SAE J517 100R8
- Meets SAE J517 electrical standards (non-conductivity) - 528N
- MSHA compliant cover - 520N
- DNV-GL Type Approved

Fittings

- 56 Series – pg. E-33
- For most Parker products, Crimp Die Selection charts are found online at www.parker.com/crimpsource
- Access instructions are on pg. G-3

Notes

- Perforated cover - 520N
- Non-perforated cover - 528N

Color

- ● Black - 520N
- ● Orange (non-conductive) - 528N

Series 520N/528N

[Visit the webpage](#)

Part Number		Nominal I.D.		Maximum O.D.		Maximum Working Pressure		Minimum Bend Radius		Weight		Permanent Fitting Series
Non-Conductive		inch	mm	inch	mm	psi	MPa	inch	mm	lbs./ft.	kg/mtr	
520N-3	528N-3	3/16	5	0.43	10.9	5,000	34.5	1-1/2	38.0	0.05	0.07	56
520N-4	528N-4	1/4	6.3	0.51	13.0	5,000	34.5	2	51.0	0.07	0.10	56
520N-5	528N-5	5/16	8	0.57	14.5	4,500	31.0	2-1/2	64.0	0.08	0.12	56
520N-6	528N-6	3/8	10	0.65	16.5	4,000	27.6	2-1/2	64.0	0.08	0.13	56
520N-8	528N-8	1/2	12.5	0.81	20.6	3,500	24.1	4	102.0	0.14	0.20	56



WARNING

This product can expose you to chemicals including Nickel compounds, which is known to the State of California to cause cancer, and Toluene, which is known to the State of California to cause birth defects or other reproductive harm. For more information go to www.P65Warnings.ca.gov.

527BA– Breathing Air Refill Hose

Nylon Core Tube

7,000 psi constant pressure.



Features

- 7,000 psi constant pressure hose

Construction

- Tube: Nylon
- Reinforcement: Aramid Fiber
- Cover: Polyurethane

Operating Parameters

- Temperature Range: -40°F (-40°C) to 180°F (82°C)
- Vacuum Rating: 28 inch Hg
- Change in length at Max. Working Pressure: +/-2%
- Min. Burst Pressure is 4x Max. Working Pressure at 73°F (23°C)

Color

- ● Blue

Compliance

- CGA G7.1-1 Grade E Breathing Air Standards
- NFPA 1901

Fittings

- CG Series – pg. E-72

101CG-2-X	102CG-4-X	137CG-4-X	141CG-4-X
101CG-4-X	103CG-4-X	139CG-4-X	1L9CG-4-X
102CG-2-X	106CG-4-X	13ECG-4-X	
- Approved configurations referenced above
- When used with 527BA hose only, Parflex -4 JIC and -4 O-ring boss fittings are rated for 7000 psi (48.3 MPa) working pressure
- Please note X in the part number references the qualified hose sizes above but does not indicate availability
- For most Parker products, Crimp Die Selection charts can be found online at www.parker.com/crimpsource
- Access instructions are on pg. G-3

Notes

- Perforated cover
- Not for use as part of a SCBA systems
- This hose is not for use between a pressure reducing regulator and breathing mask
- For fitting attachment lubricate only with water or non-toxic lubricant. Do not assemble with petroleum or hydrocarbon based lubricants. Do not flush with solvents of any kind
- This hose does not contain a conductive element; therefore, it should not be used with explosive gases such as pure oxygen and hydrogen
- Hose is compliant with CGA Grade E Breathing Air Standards, however air quality is dependent upon all system components

Series 527BA

[Visit the webpage](#)

Part Number	Nominal I.D.		Maximum O.D.		Maximum Working Pressure		Minimum Bend Radius		Weight		Permanent Fitting Series
	inch	mm	inch	mm	psi	MPa	inch	mm	lbs./ft.	kg/mtr	
527BA-3	3/16	5	0.43	10.9	7,000	48.3	1-1/2	38.0	0.05	0.07	CG
527BA-4	1/4	6.3	0.52	13.2	7,000	48.3	2	51.0	0.07	0.11	CG

WARNING



This product can expose you to chemicals including Nickel compounds, which is known to the State of California to cause cancer, and Toluene, which is known to the State of California to cause birth defects or other reproductive harm. For more information go to www.P65Warnings.ca.gov.

540N – SAE 100R7 - Hydraulic Hose

Nylon Core Tube

Low coefficient of friction jacket.



Features

- Low coefficient of friction jacket
- Special order colors
- Twin or multi-line available
- Good chemical compatibility

Construction

- Tube: Nylon
- Reinforcement: Fiber
- Cover: Polyurethane

Operating Parameters

- Temperature Range: -40°F (-40°C) to 212°F (100°C)
- Vacuum Rating: 28 inch Hg
- Change in length at Max. Working Pressure: +/-2%
- Min. Burst Pressure is 4x Max. Working Pressure at 73°F (23°C)

Compliance

- Meets/Exceeds SAE J517 100R7
- MSHA compliant cover
- DNV-GL Type Approved

Fittings

- 56 Series – pg. E-33
- For most Parker products, Crimp Die Selection charts are found online at www.parker.com/crimpsource
- Access instructions are on pg. G-3

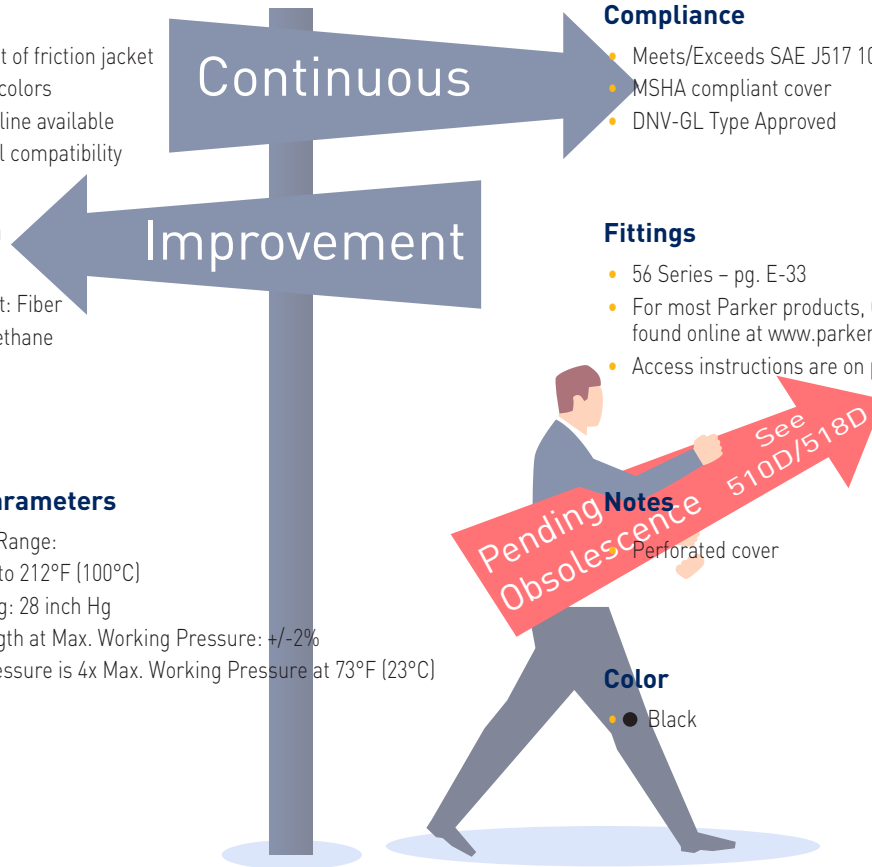

Series 540N

[Visit the webpage](#)

Part Number	Nominal I.D.		Maximum O.D.		Maximum Working Pressure		Minimum Bend Radius		Weight		Permanent Fitting Series
	inch	mm	inch	mm	psi	MPa	inch	mm	lbs./ft.	kg/mtr	
540N-2	1/8	3.2	0.34	8.6	3,000	20.7	1/2	13.0	0.03	0.05	56
540N-3	3/16	5	0.44	10.9	3,000	20.7	3/4	19.0	0.04	0.06	56
540N-4	1/4	6.3	0.50	12.7	2,750	19.0	1-1/2	38.0	0.07	0.10	56
540N-5	5/16	8	0.58	14.7	2,500	17.2	1-3/4	44.0	0.07	0.10	56
540N-6	3/8	10	0.65	16.5	2,250	15.5	2	51.0	0.09	0.13	56
540N-8	1/2	12.5	0.81	20.6	2,000	13.8	3	76.0	0.13	0.19	56
540N-12	3/4	19	1.05	26.7	1,250	8.6	6	152.0	0.17	0.25	56



WARNING

This product can expose you to chemicals including Nickel compounds, which is known to the State of California to cause cancer, and Toluene, which is known to the State of California to cause birth defects or other reproductive harm. For more information go to www.P65Warnings.ca.gov.

540P – SAE 100R7 Specialty Water Hose

Polyethylene Core Tube

Non leaching core tube.



Features

- Plasticizer free non-leaching core tube
- Low-moisture permeability
- Ideal for potable water, distilled water and de-ionized water

Construction

- Tube: Polyethylene
- Reinforcement: Fiber
- Cover: Polyurethane

Operating Parameters

- Temperature Range: -40°F (-40°C) to 150°F (66°C)
- Vacuum Rating: 28 inch Hg
- Change in length at Max. Working Pressure: +/-2%
- Min. Burst Pressure is 4x Max. Working Pressure at 73°F (23°C)

Compliance

- Meets/Exceeds SAE J517 100R7
- FDA, CFR21 Part 177 compliant core

Fittings

- 56 Series – pg. E-33
- For most Parker products, Crimp Die Selection charts are found online at www.parker.com/crimpsource
- Access instructions are on pg. G-3

Notes

- Perforated cover

Color

- ● Aqua

Series 540P

[Visit the webpage](#)

Part Number	Nominal I.D.		Maximum O.D.		Maximum Working Pressure		Minimum Bend Radius		Weight		Permanent Fitting Series
	inch	mm	inch	mm	psi	MPa	inch	mm	lbs./ft.	kg/mtr	
540P-4	1/4	6.4	.50	12.7	2,750	19.0	1-1/4	32.0	.05	.08	56
540P-6	3/8	9.5	.65	16.5	2,250	15.5	2	51.0	.09	.13	56
540P-8	1/2	12.7	.81	20.6	2,000	13.8	3	76.0	.13	.19	56

WARNING



This product can expose you to chemicals including Nickel compounds, which is known to the State of California to cause cancer, and Toluene, which is known to the State of California to cause birth defects or other reproductive harm. For more information go to www.P65Warnings.ca.gov.

53DM/538DM – DuraMax™ SAE 100R18 Low Temperature Hydraulic Hose

Copolyester Core Tube

Superior flexibility in cold temperature applications.



Features

- Low coefficient of friction cover
- Superior flexibility in cold temperature applications
- Excellent for over-the-sheave applications
- Better bend radius than SAE J517 and 100R7
- 3000 psi constant pressure

Construction

- Tube: Copolyester
- Reinforcement: Fiber
- Cover: Copolyester

Operating Parameters

- Temperature Range:
 - Petroleum based hydraulic fluids and lubricating oils within a temperature range -70°F (-57°C) to 212°F (100°C)
 - Synthetic, synthetic blend, water, and water/oil emulsion hydraulic fluids limited to 135°F (57°C)
- Vacuum Rating: 28 inch Hg
- Change in length at Max. Working Pressure: +/-2%
- Min. Burst Pressure is 4x Max. Working Pressure at 73°F (23°C)

Compliance

- Meets/Exceeds SAE J517 100R18
- Meets SAE J517 electrical standards (non-conductivity) - 538DM

Fittings

- 56 Series – pg. E-33
- For most Parker products, Crimp Die Selection charts are found online at www.parker.com/crimpsource
- Access instructions are on pg. G-3

Notes

- Perforated cover - 53DM
- Non-perforated cover - 538DM

Color

- ● Black - 53DM
- ● Orange (non-conductive) - 538DM



Series 53DM/538DM

[Visit the webpage](#)

Part Number	Nominal I.D.	Maximum O.D.		Maximum Working Pressure		Minimum Bend Radius		Weight		Permanent Fitting Series		
		inch	mm	psi	MPa	inch	mm	lbs./ft.	kg/mtr			
53DM-4	-	1/4	6.3	0.49	11.9	3,000	20.7	1-1/4	32.0	0.07	0.10	56
53DM-6	538DM-6	3/8	10	0.66	16.7	3,000	20.7	2	51.0	0.11	0.16	56
53DM-8	-	1/2	12.5	0.84	21.3	3,000	20.7	3-1/2	89.0	0.17	0.26	56
53DM-10	-	5/8	16	1.03	26.2	3,000	20.7	4	102.0	0.22	0.33	56
53DM-12	-	3/4	19	1.13	28.7	3,000	20.7	6-1/2	165.0	0.26	0.39	CG



WARNING

This product can expose you to chemicals including N-Methylpyrrolidone, which is known to the State of California to cause cancer. For more information go to www.P65Warnings.ca.gov.

55LT – SAE 100R7 Low Temperature Hydraulic Hose

Copolyester Core Tube

Superior flexibility in cold temperature applications.



Features

- Twin and multi-line available
- Superior flexibility in cold temperature applications
- Excellent for over-the-sheave applications

Compliance

- Meets/Exceeds SAE J517 100R7

Construction

- Tube: Copolyester
- Reinforcement: Fiber
- Cover: Copolyester

Fittings

- 56 Series – pg. E-33
- For most Parker products, Crimp Die Selection charts are found online at www.parker.com/crimpsource
- Access instructions are on pg. G-3

Operating Parameters

- Temperature Range:
 - 70°F (-57°C) to 212°F (100°C)
 - Water/glycol hydraulic fluids limited to 135°F (57°C)
- Vacuum Rating: 28 inch Hg
- Change in length at Max. Working Pressure: +/-2%
- Min. Burst Pressure is 4x Max. Working Pressure at 73°F (23°C)

Notes

- Perforated cover

Color

- ● Black



Series 55LT

[Visit the webpage](#)

Part Number	Nominal I.D.		Maximum O.D.		Maximum Working Pressure		Minimum Bend Radius		Weight		Permanent Fitting Series
	inch	mm	inch	mm	psi	MPa	inch	mm	lbs./ft.	kg/mtr	
55LT-2	1/8	3.2	0.34	8.6	3,000	20.7	1/2	13.0	0.03	0.05	56
55LT-3	3/16	5	0.43	10.9	3,250	22.4	3/4	19.0	0.05	0.08	56
55LT-4	1/4	6.3	0.51	13.0	3,000	20.7	1-1/4	32.0	0.07	0.10	56
55LT-5	5/16	8	0.57	14.5	2,500	17.2	1-3/4	44.0	0.09	0.13	56
55LT-6	3/8	10	0.65	16.5	2,250	15.5	2	51.0	0.10	0.14	56
55LT-8	1/2	12.5	0.81	20.6	2,000	13.8	3	76.0	0.14	0.21	56

WARNING



This product can expose you to chemicals including Nickel compounds, which is known to the State of California to cause cancer, and Toluene, which is known to the State of California to cause birth defects or other reproductive harm. For more information go to www.P65Warnings.ca.gov.

56DH – Diagnostic Hose

Nylon Core Tube

Improved signal response due to smaller I.D. and low volumetric expansion.



Features

- Improved signal response due to smaller I.D. and low volumetric expansion
- Excellent flexibility
- Ease of routing due to flexibility and small O.D.
- Light weight - up to 70% less than other diagnostic hoses
- Twin and multi-line constructions available

Construction

- Tube: Nylon
- Reinforcement: Aramid Fiber
- Cover: Polyurethane

Operating Parameters

- Temperature Range: -40°F (-40°C) to 200°F (93°C)
- Vacuum Rating: 28 inch Hg
- Change in length at Max. Working Pressure: +/-2%
- Min. Burst Pressure is 4x Max. Working Pressure at 73°F (23°C)

Compliance

- MSHA compliant cover

Fittings

- CY Series - pg. E-62 SF Series - pg. E-81
- For most Parker products, Crimp Die Selection charts are found online at www.parker.com/crimpsource
- Access instructions are on pg. G-3

Notes

- Perforated cover

Color

- ● Black

Series 56DH

[Visit the webpage](#)

Part Number	Nominal I.D.		Maximum O.D.		Maximum Working Pressure		Minimum Bend Radius		Weight		Permanent Fitting Series
	inch	mm	inch	mm	psi	MPa	inch	mm	lbs./ft.	kg/mtr	
56DH-1.5	0.09	2.3	0.21	5.3	6,000	41.4	1/4	6.4	0.01	0.02	SF
56DH-2	0.14	3.6	0.32	8.1	6,000	41.4	1/2	13.0	0.03	0.05	CY



WARNING

This product can expose you to chemicals including Nickel compounds, which is known to the State of California to cause cancer, and Toluene, which is known to the State of California to cause birth defects or other reproductive harm. For more information go to www.P65Warnings.ca.gov.

575X - Fast response Hose

Nylon Core Tube

5,000 psi constant pressure
and long, continuous lengths.



Features

- Light weight
- Low change in length under pressure
- Low volumetric expansion
- Fast response even over longer lengths
- 5000 psi constant pressure

Construction

- Tube: Nylon
- Reinforcement: Aramid Fiber
- Cover: Polyurethane; 575XN -8 Nylon

Operating Parameters

- Temperature Range:
-40°F (-40°C) to 212°F (100°C)
- Vacuum Rating: 28 inch Hg
- Change in length at Max. Working Pressure: +/-2%
- Min. Burst Pressure is 4x Max. Working Pressure at 73°F (23°C)

Compliance

- MSHA compliant cover (575X only)
- DNV-GL Type Approved

Fittings

- CG Series – pg. E-72
- For most Parker products, Crimp Die Selection charts are found online at www.parker.com/crimpsource
- Access instructions are on pg. G-3

Notes

- Non-perforated cover
- 575XN - Not available in twin-line or multi-line constructions

Color

- ● Black

Series 575X/575XN

[Visit the webpage](#)

Part Number	Nominal I.D.		Maximum O.D.		Maximum Working Pressure		Minimum Bend Radius		Weight		Permanent Fitting Series
	inch	mm	inch	mm	psi	MPa	inch	mm	lbs./ft.	kg/mtr	
575X-3	3/16	5	0.43	10.9	5,000	34.5	1-1/2	38.0	0.05	0.07	CG
575X-4	1/4	6.3	0.51	13.0	5,000	34.5	2	51.0	0.07	0.10	CG
575X-6	3/8	10	0.64	16.3	5,000	34.5	3	76.0	0.09	0.13	CG
575XN-8	1/2	12.5	0.81	20.6	5,000	34.5	4	102.0	0.14	0.21	CG
575X-12	3/4	19	1.15	29.2	5,000	34.5	8	203.0	0.24	0.36	CG
575X-16	1	25	1.59	40.4	5,000	34.5	10	254.0	0.36	0.54	CG

WARNING



This product can expose you to chemicals including Nickel compounds, which is known to the State of California to cause cancer, and Toluene, which is known to the State of California to cause birth defects or other reproductive harm. For more information go to www.P65Warnings.ca.gov.

580N/588N – SAE 100R8 High Pressure Hydraulic Hose

Nylon Core Tube

Lighter weight and smaller O.D. than comparable hoses with same working pressure.



Features

- Twin and multi-line available
- Lighter weight and smaller O.D. than 100R2

Construction

- Tube: Nylon
- Reinforcement: Fiber
- Cover: Polyurethane

Operating Parameters

- Temperature Range: -40°F (-40°C) to 212°F (100°C)
- Vacuum Rating: 28 inch Hg
- Change in length at Max. Working Pressure: +/-2%
- Min. Burst Pressure is 4x Max. Working Pressure at 73°F (23°C)

Compliance

- Meets/Exceeds SAE J517 100R8
- Meets SAE J517 electrical standards (non-conductivity) - 588N
- MSHA compliant cover - 580N
- DNV-GL Type Approved

Fittings

- 56 Series – pg. E-33
- For most Parker products, Crimp Die Selection charts are found online at www.parker.com/crimpsource
- Access instructions are on pg. G-3

Notes

- Perforated cover - 580N
- *Non-perforated cover - 588N

Color

- ● Black - 580N
- ● Orange (non-conductive) - 588N

Series 580N/588N

[Visit the webpage](#)

Part Number		Nominal I.D.		Maximum O.D.		Maximum Working Pressure		Minimum Bend Radius		Weight		Permanent Fitting Series
Non-Conductive		inch	mm	inch	mm	psi	MPa	inch	mm	lbs./ft.	kg/mtr	
580N-8	588N-8*	1/2	12.5	0.89	22.6	3,500	24.1	4	102.0	0.21	0.31	56
580N-10	588N-10*	5/8	16	0.98	24.9	2,750	19.0	6	152.0	0.21	0.31	56
580N-12	588N-12*	3/4	19	1.15	29.2	2,250	15.5	8	203.0	0.23	0.35	56
580N-16	588N-16*	1	25	1.47	37.3	2,000	13.8	10	254.0	0.38	0.56	56



WARNING

This product can expose you to chemicals including Nickel compounds, which is known to the State of California to cause cancer, and Toluene, which is known to the State of California to cause birth defects or other reproductive harm. For more information go to www.P65Warnings.ca.gov.

83FR – DuraGard™ General Purpose Polyurethane

Polyurethane Core Tube

Weld spatter resistant.



Features

- Weld spatter resistant
- Excellent abrasion resistance
- Excellent flexibility
- Compact bend radius
- Specially Formulated Polyurethane tube
- Twin-line or multi-line constructions available

Construction

- Tube: Specially Formulated Polyurethane
- Reinforcement: Fiber
- Cover: Polyurethane

Operating Parameters

- Temperature Range: -20°F (-29°C) to 200°F (93°C)
- Vacuum Rating: 28 inch Hg
- Change in length at Max. Working Pressure: +/-2%
- Min. Burst Pressure is 4x Max. Working Pressure at 73°F (23°C)

Compliance

- Meets SAE J517 electrical standards (non-conductivity)
- UL94HB compliant
- MSHA compliant cover

Fittings

- 56 Series – pg. E-33 82 Series – Available from Parker Hose Products Division
- For most Parker products, Crimp Die Selection charts can be found online at www.parker.com/crimpsource
- Access instructions are on pg. G-3

Notes

- *Temperature and pressure reduced with 82 series Push-Lok Fitting: -20°F (-29°C) to 145°F (62°C) 175 psi maximum working pressure
- Non-perforated cover

Color

- ● Black (BLK)
- ● Blue (BLU)
- ● Brown (BRN)
- ● Green (GRN)
- ● Gray (GRA)
- ● Red (RED)

Series 83FR

[Visit the webpage](#)

Part Number	Nominal I.D.		Maximum O.D.		Maximum Working Pressure		Minimum Bend Radius		Weight		Permanent Fitting Series	Push-Lok Fitting*
	inch	mm	inch	mm	psi	MPa	inch	mm	lbs./ft.	kg/mtr		
83FR-4	1/4	6.3	0.48	12.2	300	2.1	1	25.0	0.05	0.07	56	82*
83FR-6	3/8	10	0.60	15.2	300	2.1	2	51.0	0.08	0.11	56	82*
83FR-8	1/2	12.5	0.76	19.3	300	2.1	2-1/2	64.0	0.12	0.17	56	82*
83FR-12	3/4	19	1.04	26.4	300	2.1	3-1/2	89.0	0.19	0.28	56	82*



WARNING

This product can expose you to chemicals including N-Methylpyrrolidone, which is known to the State of California to cause cancer. For more information go to www.P65Warnings.ca.gov.

1035HT – High Temperature Power Cleaning

Nylon Core Tube

Handles temperatures up to 230°F (110°C).



Features

- Non-marring
- Broad temperature range

Construction

- Tube: Nylon
- Reinforcement: Fiber
- Cover: Polyurethane

Operating Parameters

- Temperature Range: -40°F (-40°C) to 230°F (110°C)
- Vacuum Rating: 28 inch Hg
- Change in length at Max. Working Pressure: +/-2%
- Min. Burst Pressure is 4x Max. Working Pressure at 73°F (23°C)

Fittings

- 56 Series – pg. E-33
- For most Parker products, Crimp Die Selection charts are found online at www.parker.com/crimpsource
- Access instructions are on pg. G-3

Notes

- Perforated cover
- Chlorinated solvents should not be used
- Also available with a blue jacket (1035HT-4-BLU) upon request
- HBR (Hose Bend Restrictor) suggested for carpet cleaning applications - See Hose Guard in Tooling Equipment and Accessories Section pg. F-18

Color

- ● Yellow

Series 1035HT

[Visit the webpage](#)

Part Number	Nominal I.D.		Maximum O.D.		Maximum Working Pressure		Minimum Bend Radius		Weight		Permanent Fitting Series
	inch	mm	inch	mm	psi	MPa	inch	mm	lbs./ft.	kg/mtr	
1035HT-4	1/4	6.3	0.50	12.7	1,750	12.1	1-1/2	38.0	0.06	0.08	56



WARNING

This product can expose you to chemicals including Nickel compounds, which is known to the State of California to cause cancer, and Toluene, which is known to the State of California to cause birth defects or other reproductive harm. For more information go to www.P65Warnings.ca.gov.

B9 – General Purpose Transfer Hose

Polyurethane Core Tube

Specially formulated polyurethane for increased chemical resistance.



Features

- Excellent flexibility
- Light weight
- Specially Formulated Polyurethane core tube for good chemical compatibility

Construction

- Tube: Specially Formulated Polyurethane
- Reinforcement: Fiber
- Cover: Specially Formulated Polyurethane

Fittings

- 56 Series – pg. E-33 82 Series - Fittings available from Parker Hose Products Division
- For most Parker products, Crimp Die Selection charts can be found online at www.parker.com/crimpsource
- Access instructions are on pg. G-3

Operating Parameters

- Temperature Range:
 - 40°F (-40°C) to 200°F (93°C)
 - Water/glycol hydraulic fluids limited to 130°F (54°C)
- Vacuum Rating: 28 inch Hg
- Change in length at Max. Working Pressure: +/-2%
- Min. Burst Pressure is 4x Max. Working Pressure at 73°F (23°C)

Notes

- *Temperature and pressure reduced with 82 series Push-Lok Fitting: -20°F (-29°C) to 100°F (38°C) 100 psi maximum working pressure
- Non-perforated cover

Color

- ● Red
- ● Black (BK) - B904BK

Series B9

[Visit the webpage](#)

Part Number	Nominal I.D.		Maximum O.D.		Maximum Working Pressure		Minimum Bend Radius		Weight		Permanent Fitting Series	Push-Lok Fitting*
	inch	mm	inch	mm	psi	MPa	inch	mm	lbs./ft.	kg/mtr		
B903	3/16	5	0.39	9.9	250	1.7	1	25.0	0.04	0.06	56	–
B904	1/4	6.3	0.46	11.7	250	1.7	1-1/2	38.0	0.05	0.07	56	82*
B905	5/16	8	0.55	14.0	250	1.7	2	51.0	0.08	0.12	56	–
B906	3/8	10	0.64	16.3	250	1.7	3	76.0	0.09	0.13	56	82*
B908	1/2	12.5	0.78	19.8	250	1.7	3	76.0	0.13	0.19	56	82*
B910	3/4	16	0.92	23.4	250	1.7	4	102.0	0.20	0.30	56	82*



WARNING

This product can expose you to chemicals including N-Methylpyrrolidone, which is known to the State of California to cause cancer. For more information go to www.P65Warnings.ca.gov.

5CNG – Compressed Natural Gas Hose

Electrically Conductive Nylon Core Tube

High pressure CNG transfer hose conforms to ANSI, CSA, ECE, and NFPA 52.



Features

- Electrically conductive core tube perforated polyurethane cover
- Sizes up to 1"
- Twin-line assemblies available to reduce installation time, eliminate tangling and reduce component part numbers

Construction

- Tube: Electrically Conductive Nylon
- Reinforcement: Aramid Fiber
- Cover: Polyurethane

Operating Parameters

- Temperature Range: -40°F (-40°C) to 185°F (85°C)
- Vacuum Rating: 28 inch Hg
- Change in length at Max. Working Pressure: +/-2%
- Min. Burst Pressure is 4x Max. Working Pressure at 73°F (23°C)

Color

- ● Red

Compliance

- ANSI/CSA NGV 4.2*CSA 12.52 (Class A, Class D)
- ECE R110 CNG Class 6
- ANSI NGV 3.1*CSA 12.3 (Class B - P36) 5CNG-8 only
- NFPA 52
- CSA Certified (www.csagroup.org)

Fittings

- CG Series – pg. E-72

Notes

- Perforated cover
- Assemblies only - CNG hose must be assembled at the factory or by a Parflex approved facility
- Appropriate wire and vinyl guards must be used on ANSI/CSA compliant single-line and twin-line bonded hose assemblies.
 - {-4 to -8 SS wire guards - pg. F-17}
 - {-12 & -16 Vinyl guards - pg. F-16}

Accessories

- 5PSG - Stainless steel spring guard
- CNGG5 - Vinyl hose guardd

Series 5CNG

[Visit the webpage](#)

Part Number	Nominal I.D.		Maximum O.D.		Maximum Working Pressure		Minimum Bend Radius		Weight	
	inch	mm	inch	mm	psi	MPa	inch	mm	lbs./ft.	kg/mtr
5CNG-4	1/4	6.3	0.55	14.0	5,000	34.5	2	51.0	0.08	0.11
5CNG-6	3/8	10	0.65	16.5	5,000	34.5	3	76.0	0.09	0.13
5CNG-8	1/2	12.5	0.90	22.9	5,000	34.5	4	102.0	0.21	0.31
5CNG-12	3/4	19	1.19	30.2	5,000	34.5	7-1/2	191.0	0.24	0.36
5CNG-16	1	25	1.59	40.4	5,000	34.5	10	254.0	0.36	0.53



WARNING

This product can expose you to chemicals including Antimony Oxide [Antimony Trioxide], which is known to the State of California to cause cancer, and 2-Imidazolidinethione, which is known to the State of California to cause birth defects or other reproductive harm. For more information go to www.P65Warnings.ca.gov.

CNGRP – Regulated Pressure Natural Gas Hose

Electrically Conductive Nylon Core Tube

Low pressure CNG transfer for on-vehicle use downstream of the pressure regulator.



Features

- For use downstream of the pressure regulator
- Approved for both under body and engine compartment installations

Compliance

- ANSI CSA NGV 3.1
- NFPA 52
- CSA 12.3, Class C
- CSA Certified (www.csagroup.org)

Construction

- Tube: Electrically Conductive Nylon
- Reinforcement: Stainless Steel
- Cover: TPV

Fittings

- 91N Series - pg. E-51
- | | | |
|---------------|---------------|---------------|
| 10691N-8-10C | 10691N-12-12C | 1JC91N-12-12C |
| 10691N-10-10C | 1AL91N-10-12C | 1TU91N-10-12C |
| 10691N-10-12C | 1AL91N-12-12C | 1TU91N-12-12C |

Operating Parameters

- Temperature Range:
-40°F (-40°C) to 250°F (121°C)
- Change in length at Max. Working Pressure: +2%/-4%
- Min. Burst Pressure is 4x Max. Working Pressure at 73°F (23°C)

Notes

- For use with natural gas only
- Factory-made assemblies only
- For sizes 3, 4 and 6 please contact the division for information on 8LPG hose which is certified according to ECE R 67 class 1, ECE R110 and AS/NZS 1869

Color

- ● Red

Series CNGRP

[Visit the webpage](#)

Part Number	Nominal I.D.		Maximum O.D.		Maximum Working Pressure		Minimum Bend Radius		Weight	
	inch	mm	inch	mm	psi	MPa	inch	mm	lbs./ft.	kg/mtr
CNGRP-10	1/2	12.5	0.89	22.6	500	3.5	4	102.0	0.26	0.39
CNGRP-12	3/4	16	1.04	26.4	500	3.5	5	127.0	0.30	0.45



WARNING

This product can expose you to chemicals including Antimony Oxide (Antimony Trioxide), which is known to the State of California to cause cancer, and 2-Imidazolidinethione, which is known to the State of California to cause birth defects or other reproductive harm. For more information go to www.P65Warnings.ca.gov.

8LPG – Propane and Natural Gas Hose

Nylon Core Tube

In LPG and CNG systems, 8LPG hose allows for customization, reliability and versatility.



Features

- Flexibility and small bend radius makes mounting and installations easier and quicker
- Available in long lengths which reduces fitting components, weight and possible leak points
- Preformed hoses available for mounting in long chassis like buses and trucks

Construction

- Tube: Nylon (Polyamide)
- Reinforcement: Fiber
- Cover: Nylon (Polyamide)

Operating Parameters

- Temperature Range :
-13°F (-25°C) to 212°F (100°C)
- Vacuum Rating: 28 inch Hg
- Min. Burst Pressure is 4x Max. Working Pressure at 73°F (23°C)

Color

- ● Black

Compliance

- ECE R67 Class 1
- ECE R110 CNG Class 6
- CSA Certified (www.csagroup.org)

Fittings

- PX-LPG Series Contact Parflex for options

Notes

- Perforated cover
- Flame resistant cover, add -FR (*Improved mechanical and chemical protection through flame resistant 2nd outer cover)
- Factory assemblies only

Series 8LPG

[Visit the webpage](#)

Part Number	Nominal I.D.		Maximum O.D.		Maximum Working Pressure		Minimum Bend Radius		Weight	
	inch	mm	inch	mm	psi	MPa	inch	mm	lbs./ft.	kg/mtr
8LPG-3	3/16	4.8	2.03	8	435	3.0	1.90	50	0.23	0.33
8LPG-3-FR*			2.41	9.5			2.95	75	0.39	0.58
8LPG-4	1/4	6.3	2.49	9.8	435	3.0	3.54	90	0.29	0.43
8LPG-4-FR*			2.92	11.5			3.94	100	0.48	0.71
8LPG-5	5/16	7.9	3.10	12.2	435	3.0	1.90	50	0.45	0.67
8LPG-5-FR*			3.51	13.8			2.95	75	0.57	0.85
8LPG-6	3/8	9.5	3.48	13.7	435	3.0	3.54	90	1.13	0.75
8LPG-6-FR*			3.89	15.3			435	3.0	3.94	100



WARNING

This product can expose you to chemicals including Titanium dioxide, which is known to the State of California to cause cancer. For more information go to www.P65Warnings.ca.gov.

HLB/HLBD – SAE 100R7 Hydraulic & Lubrication Hose

Copolyester Core Tube/Nylon Core Tube

Compact 1/8" I.D. hoses save hundreds of dollars of waste.



Features

- HLB/HLBD remote lubrication system versus 1/4" rubber hoses can save money per line in reduced component and installation labor costs
- Unique GK bulkhead hose fittings with integrated nipple can save money per zerk connection in unnecessary adapter costs
- Compact 1/8" hoses save hundreds of dollars of waste in your operation by eliminating gallons of unnecessary "in-line" grease versus larger bore rubber hoses

Construction

- Tube: HLBD02 - Nylon
HLB03 - Copolyester
- Reinforcement: Fiber
- Cover: Polyurethane

Operating Parameters

- Temperature Range:
 - Petroleum based hydraulic fluids and lubricating oils within a temperature range -40°F (-40°C) to 212°F (100°C)
 - Synthetic, synthetic blend, water, and water/oil emulsion hydraulic fluids limited to 135°F (57°C) (HLB03 only)
 - BU Series Field Attachable Fitting limited to 120°F (48°C)
- Vacuum Rating: 28 inch Hg
- Change in length at Max. Working Pressure: +/-3%
- Min. Burst Pressure is 4x Max. Working Pressure at 73°F (23°C)

Compliance

- Meets/Exceeds SAE J517 100R7 - HLBD02
- MSHA compliant cover

Fittings

- CY Series – pg. E-62 BU Series - pg. E-31
- For most Parker products, Crimp Die Selection charts are found online at www.parker.com/crimpsource
- Access instructions are on pg. G-3

Notes

- Perforated cover - HLBD02
- Non-perforated cover - HLB03

Color

- ● Black

Series HLB/HLBD

[Visit the webpage](#)

Part Number	Nominal I.D.		Maximum O.D.		Maximum Working Pressure		Minimum Bend Radius		Weight		Permanent Fitting Series	Field Attachable Series
	inch	mm	inch	mm	psi	MPa	inch	mm	lbs./ft.	kg/mtr		
HLBD02	1/8	3.2	0.32	8.1	3,000	20.7	1/2	13.0	0.03	0.04	CY	BU
HLB03	3/16	5	0.41	10.4	3,000	20.7	3/4	19.0	0.06	0.08	CY	BU

WARNING



This product can expose you to chemicals including Nickel compounds, which is known to the State of California to cause cancer, and Toluene, which is known to the State of California to cause birth defects or other reproductive harm. For more information go to www.P65Warnings.ca.gov.

MSH – Marine Steering Hose

Nylon Core Tube

Salt water resistant.



Features

- Fast, accurate response
- Permanent or field attachable fittings
- Salt water, corrosion resistant
- Ideal for marine hydraulic steering systems

Construction

- Tube: Nylon
- Reinforcement: Fiber
- Cover: Polyurethane

Fittings

- MS Series – pg. E-65; E-80
- For most Parker products, Crimp Die Selection charts are found online at www.parker.com/crimpsource
- Access instructions are on pg. G-3

Operating Parameters

- Temperature Range: -40°F (-40°C) to 200°F (93°C)
- Vacuum Rating: 28 inch Hg
- Change in length at Max. Working Pressure: +/-2%
- Min. Burst Pressure is 4x Max. Working Pressure at 73°F (23°C)

Notes

- Non-perforated cover
- Bend restrictor (HBR) available for only permanent fittings (pg. F-16)

Color

- ● Black

Series MSH

[Visit the webpage](#)

Part Number	Nominal I.D.		Maximum O.D.		Maximum Working Pressure		Minimum Bend Radius		Weight		Permanent Fitting Series	Field Attachable Series
	inch	mm	inch	mm	psi	MPa	inch	mm	lbs./ft.	kg/mtr		
MSH-5	5/16	8	0.48	12.2	1,000	6.9	2-1/4	57.0	0.05	0.07	MS	MS
MSH-6	3/8	10	0.59	15.0	1,000	6.9	3	76.0	0.07	0.11	MS	MS



WARNING

This product can expose you to chemicals including Nickel compounds, which is known to the State of California to cause cancer, and Toluene, which is known to the State of California to cause birth defects or other reproductive harm. For more information go to www.P65Warnings.ca.gov.

MSXL – Fast Response Marine Steering Hose

Nylon Core Tube

Fast, accurate response with a salt water resistant cover.



Features

- Fast, accurate response in marine steering systems
- Low volumetric expansion
- Salt water resistant cover
- Ideal for marine hydraulic steering systems

Construction

- Tube: Nylon
- Reinforcement: Aramid Fiber
- Cover: Polyurethane

Fittings

- MS Series – Permanent Crimp Only E-80
- For most Parker products, Crimp Die Selection charts are found online at www.parker.com/crimpsource
- Access instructions are on pg. G-3

Operating Parameters

- Temperature Range: -40°F (-40°C) to 185°F (85°C)
- Vacuum Rating: 28 inch Hg
- Change in length at Max. Working Pressure: +/-2%
- Min. Burst Pressure is 4x Max. Working Pressure at 73°F (23°C)

Notes

- Non-perforated cover
- Bend restrictor (HBR) available for only permanent fittings (pg. F-16)

Color

- ● Black

Series MSXL

[Visit the webpage](#)

Part Number	Nominal I.D.		Maximum O.D.		Maximum Working Pressure		Minimum Bend Radius		Weight		Permanent Fitting Series
	inch	mm	inch	mm	psi	MPa	inch	mm	lbs./ft.	kg/mtr	
MSXL-5	5/16	8	0.50	12.7	1,500	10.3	2-1/4	57.0	0.05	0.07	MS



WARNING

This product can expose you to chemicals including Nickel compounds, which is known to the State of California to cause cancer, and Toluene, which is known to the State of California to cause birth defects or other reproductive harm. For more information go to www.P65Warnings.ca.gov.

PTH – Marine Power Tilt Hose

Nylon Core Tube

Designed for power tilt mechanisms, trim tab assemblies and jack plate assemblies.



Features

- Compact design
- Abrasion resistant polyurethane cover
- Excellent flexibility
- Corrosion resistant

Construction

- Tube: Nylon
- Reinforcement: Fiber and Stainless Steel Wire
- Cover: Polyurethane

Fittings

- 92 Series – pg. E-61
- For most Parker products, Crimp Die Selection charts are found online at www.parker.com/crimpsource
- Access instructions are on pg. G-3

Operating Parameters

- Temperature Range:
 - 40°F (-40°C) to 212°F (100°C)
- Change in length at Max. Working Pressure: +/-2%
- Min. Burst Pressure is 4x Max. Working Pressure at 73°F (23°C)

Notes

- Non-perforated cover
- Also available as custom order with black cover
- SS wire overbraid for enhanced kink resistance and cut through protection

Color

- ○ Clear

Series PTH

[Visit the webpage](#)

Part Number	Nominal I.D.		Maximum O.D.		Maximum Working Pressure		Minimum Bend Radius		Weight		Permanent Fitting Series
	inch	mm	inch	mm	psi	MPa	inch	mm	lbs./ft.	kg/mtr	
PTH-3	3/16	5	0.43	10.9	3,000	20.7	3/4	19.0	0.08	0.11	92



WARNING

This product can expose you to chemicals including Nickel compounds, which is known to the State of California to cause cancer, and Toluene, which is known to the State of California to cause birth defects or other reproductive harm. For more information go to www.P65Warnings.ca.gov.

S5N – Predator™ Hose (Water Jetting/Lateral Cleaning)

Nylon Core Tube

High-pressure water equipment
in lateral sewer lines.



Features

- Easily identified lime green cover signifies 4000 psi constant pressure
- Slim profile and light weight provide easy handling and routing
- High-pressure water equipment for cleaning or debris removal in lateral sewer lines

Construction

- Tube: Gray Nylon
- Reinforcement: Aramid Fiber
- Cover: Polyurethane

Fittings

- 56 Series – pg. E-33
- For most Parker products, Crimp Die Selection charts are found online at www.parker.com/crimpsource
- Access instructions are on pg. G-3

Operating Parameters

- Temperature Range:
-40°F (-40°C) to 135°F (57°C)
- Vacuum Rating: 28 inch Hg
- Change in length at Max. Working Pressure: +/-2%
- Min. Burst Pressure is 4x Max. Working Pressure at 73°F (23°C)

Notes

- Perforated cover
- All standard assembly lengths coupled with rigid male pipe (NPT) each end
- Not for use in hydraulic applications

Color

- ● Green

Series S5N

[Visit the webpage](#)

Part Number	Nominal I.D.		Maximum O.D.		Maximum Working Pressure		Minimum Bend Radius		Weight		Permanent Fitting Series
	inch	mm	inch	mm	psi	MPa	inch	mm	lbs./ft.	kg/mtr	
S508N	1/2	12.5	0.81	20.6	4000	28.0	4	102.0	0.16	0.24	56

WARNING



This product can expose you to chemicals including Nickel compounds, which is known to the State of California to cause cancer, and Toluene, which is known to the State of California to cause birth defects or other reproductive harm. For more information go to www.P65Warnings.ca.gov.

S6 – Predator™ Hose (Sewer Cleaning)

Copolyester Core Tube

2,500 psi pressure and high-volume water equipment in large sewer lines.



Features

- Easily identified orange cover signifies 2500 psi constant pressure
- Bonded construction provides excellent kink resistance and flexibility
- High-pressure and high-volume water equipment for cleaning or debris removal in large sewer lines

Construction

- Tube: Gray Copolyester
- Reinforcement: Fiber
- Cover: Polyurethane

Fittings

- SQ Series (Swage Only) – pg. E-82 HY Series – Fittings available from Parker Hose Products Division
- For most Parker products, Crimp Die Selection charts can be found online at www.parker.com/crimpsource
- Access instructions are on pg. G-3

Operating Parameters

- Temperature Range: -40°F (-40°C) to 135°F (57°C)
- Vacuum Rating: 28 inch Hg
- Change in length at Max. Working Pressure: +/-2%
- Min. Burst Pressure is 2.5x Max. Working Pressure at 73°F (23°C)

Notes

- All standard assembly lengths coupled with rigid male pipe (NPT) each end
- Not for use in hydraulic applications
- Perforated cover

Color

- ● Orange

Series S6

[Visit the webpage](#)

Part Number	Nominal I.D.		Maximum O.D.		Maximum Working Pressure		Minimum Bend Radius		Weight		Permanent Fitting Series
	inch	mm	inch	mm	psi	MPa	inch	mm	lbs./ft.	kg/mtr	
S612	3/4	19	1.15	29.2	2,500	17.2	4	102.0	0.27	0.40	SQ/HY
S616	1	25	1.42	36.1	2,500	17.2	6	152.0	0.36	0.53	SQ/HY



WARNING

This product can expose you to chemicals including Nickel compounds, which is known to the State of California to cause cancer, and Toluene, which is known to the State of California to cause birth defects or other reproductive harm. For more information go to www.P65Warnings.ca.gov.

S9 – Predator™ Hose (Sewer Cleaning)

Copolyester Core Tube

3,000 psi pressure and high-volume water equipment in large sewer lines.



Features

- Easily identified blue cover signifies 3000 psi constant pressure
- Bonded construction provides excellent kink resistance and flexibility
- High-pressure and high-volume water equipment for cleaning or debris removal in large sewer lines

Construction

- Tube: Gray Copolyester
- Reinforcement: Aramid Fiber
- Cover: Polyurethane

Fittings

- SQ Series (Swage Only) – pg. E-68 HY Series - Fittings available from Parker Hose Products Division
- For most Parker products, Crimp Die Selection charts can be found online at www.parker.com/crimpsource
- Access instructions are on pg. G-3

Operating Parameters

- Temperature Range: -40°F (-40°C) to 135°F (57°C)
- Vacuum Rating: 28 inch Hg
- Change in length at Max. Working Pressure: +/-2%
- Min. Burst Pressure is 2.5x Max. Working Pressure at 73°F (23°C)

Notes

- All standard assembly lengths coupled with rigid male pipe (NPT) each end
- Not for use in hydraulic applications
- Perforated cover

Color

- ● Blue

Series S9

[Visit the webpage](#)

Part Number	Nominal I.D.		Maximum O.D.		Maximum Working Pressure		Minimum Bend Radius		Weight		Permanent Fitting Series
	inch	mm	inch	mm	psi	MPa	inch	mm	lbs./ft.	kg/mtr	
S912	3/4	19	1.16	29.5	3,000	20.7	4	102.0	0.28	0.42	SQ/HY
S916	1	25	1.48	37.6	3,000	20.7	8	203.0	0.41	0.61	SQ/HY

WARNING



This product can expose you to chemicals including Nickel compounds, which is known to the State of California to cause cancer, and Toluene, which is known to the State of California to cause birth defects or other reproductive harm. For more information go to www.P65Warnings.ca.gov.

919/919B - SAE 100R14 PTFE Hose

PTFE Core Tube

Best chemical resistance with high operating temperature (450°F/232°C).



Features

- Excellent chemical compatibility
- Handles extreme temperatures to 450°F
- Environmentally safe
- Resists moisture
- Low friction minimizes pressure drops and deposits

Construction

- Tube: 919 - Natural FDA Compliant PTFE
919B - Black Static-Dissipative PTFE
- Reinforcement: 304 Stainless Steel Braid

Operating Parameters

- Temperature Range:
-100°F (-73°C) to 450°F (232°C)
- Change in length at Max. Working Pressure: +2% to -4%
- Min. Burst Pressure is 4x Max. Working Pressure at 73°F (23°C)

Compliance

- Meets/Exceeds SAE J517 100R14A - 919
- Meets/Exceeds SAE J517 100R14B - 919B
- FDA CFR21 Part 177 compliant core - 919

Fittings

- 90 Series – pg. E-26 91/91N Series – pg. E-52
- For most Parker products, Crimp Die Selection charts are found online at www.parker.com/crimpsource
- Access instructions are on pg. G-3

Notes

- Use hose type 919B with static-dissipative core tube when conveying non-conducting fluids such as oils, paints, fuels, steam, etc.
- Constructed with minimum .030" PTFE tube wall thickness

Series 919/919B

[Visit the webpage](#)

Part Number		Nominal I.D.		Maximum O.D.		Maximum Working Pressure		Minimum Bend Radius		Vacuum Rating	Weight		Permanent Fitting Series	Field Attachable Series
Natural	Static-Dissipative	inch	mm	inch	mm	psi	MPa	inch	mm	Hg/73F	lbs./ft.	kg/mtr		
919-4	919B-4	3/16	5	0.33	8.2	3,000	20.7	2	50.0	28	0.06	0.09	91N	90
919-5	919B-5	1/4	6.3	0.40	10.1	3,000	20.7	3	75.0	28	0.09	0.13	91N	90
919-6	919B-6	5/16	8	0.46	11.6	2,500	17.2	4	100.0	28	0.10	0.15	91N	90
919-8	919B-8	13/32	10.4	0.56	14.3	2,000	13.8	5	127.0	28	0.13	0.19	91N	90
919-10	-	1/2	12.5	0.66	16.8	1,500	10.3	6-1/2	165.0	28	0.15	0.22	91N	90
919-12	-	5/8	16	0.79	20.1	1,200	8.3	7-1/2	191.0	12	0.19	0.28	91N	90
919-16	-	7/8	22	1.06	26.9	1,000	6.9	9	229.0	14	0.27	0.40	91N	90



WARNING

This product can expose you to chemicals including Tetrafluoroethylene, which is known to the State of California to cause cancer. For more information go to www.P65Warnings.ca.gov.

919J/919BJ – Silicone Covered SAE 100R14 PTFE Hose

PTFE Core Tube

Steam cleanable with silicone cover for operator protection.



Features

- Silicone cover provides a clean, smooth cover to protect the stainless steel wire reinforcement against wear, fraying and contaminants
- Steam cleanable

Compliance

- Meets/Exceeds SAE J517 100R14A - 919J
- Meets/Exceeds SAE J517 100R14B - 919BJ
- FDA CFR21 Part 177 compliant core - 919J

Construction

- Tube: 919J - Natural FDA Compliant PTFE
919BJ - Black Static-Dissipative PTFE
- Reinforcement: 304 Stainless Steel Braid
- Cover: Extruded Silicone

Fittings

- 91N Series – pg. E-52
- For most Parker products, Crimp Die Selection charts are found online at www.parker.com/crimpsource
- Access instructions are on pg. G-3

Operating Parameters

- Temperature Range:
-40°F (-40°C) to 450°F (232°C)
- Change in length at Max. Working Pressure: +2% to -4%
- Min. Burst Pressure is 4x Max. Working Pressure at 73°F (23°C)

Notes

- Cover must be skived prior to fitting attachment
- Constructed with minimum .030" PTFE tube wall thickness

Color

- Red - 919J
- Orange - 919BJ

Series 919J/919BJ

[Visit the webpage](#)

Part Number		Nominal I.D.		Maximum O.D.		Maximum Working Pressure		Minimum Bend Radius		Vacuum Rating	Weight		Permanent Fitting Series
Natural	Static-Dissipative	inch	mm	inch	mm	psi	MPa	inch	mm	Hg/73F	lbs./ft.	kg/mtr	
919J-4-RED	919BJ-4-ORG	3/16	5	0.45	11.4	3,000	20.7	2	50.0	28	0.12	0.18	91N
919J-5-RED	919BJ-5-ORG	1/4	6.3	0.52	13.2	3,000	20.7	3	75.0	28	0.14	0.21	91N
919J-6-RED	919BJ-6-ORG	5/16	8	0.58	14.8	2,500	17.2	4	100.0	28	0.17	0.25	91N
919J-8-RED	919BJ-8-ORG	13/32	10.4	0.68	17.3	2,000	13.8	5	127.0	28	0.20	0.30	91N
919J-10-RED	919BJ-10-ORG	1/2	12.5	0.78	19.8	1,500	10.3	6-1/2	165.0	28	0.24	0.35	91N
919J-12-RED	919BJ-12-ORG	5/8	16	0.91	23.1	1,200	8.3	7-1/2	191.0	12	0.29	0.43	91N
919J-16-RED	919BJ-16-ORG	7/8	22	1.19	30.2	1,000	6.9	9	229.0	14	0.38	0.56	91N



WARNING

This product can expose you to chemicals including Tetrafluoroethylene, which is known to the State of California to cause cancer. For more information go to www.P65Warnings.ca.gov.

919U - Abrasion Resistant SAE 100R14 PTFE Hose

PTFE Core Tube

Non-marring, abrasion resistant polyurethane cover.



Features

- Non-marring, abrasion resistant polyurethane cover protects the stainless steel wire reinforcement against wear, fraying and contaminants

Construction

- Tube: Natural FDA Compliant PTFE
- Reinforcement: 304 Stainless Steel Braid
- Cover: Polyurethane

Operating Parameters

- Temperature Range::
-40°F (-40°C) to 275°F (135°C)
- Change in length at Max. Working Pressure: +2% to -4%
- Min. Burst Pressure is 4x Max. Working Pressure at 73°F (23°C)

Compliance

- Meets/Exceeds SAE J517 100R14A
- Limited to temperature range of -40°F to 275°F
- FDA CFR21 Part 177 compliant core

Fittings

- 91N Series – pg. E-52
- For most Parker products, Crimp Die Selection charts are found online at www.parker.com/crimpsource
- Access instructions are on pg. G-3

Notes

- Cover must be skived prior to fitting attachment
- Constructed with minimum .030" PTFE tube wall thickness

Color

- ● Black

Series 919U

[Visit the webpage](#)

Part Number	Nominal I.D.		Maximum O.D.		Maximum Working Pressure		Minimum Bend Radius		Vacuum Rating	Weight		Permanent Fitting Series
	inch	mm	inch	mm	psi	MPa	inch	mm	Hg/73F	lbs./ft.	kg/mtr	
919U-4	3/16	5	0.37	9.4	3,000	20.7	2	50.0	28	0.08	0.13	91N
919U-6	5/16	8	0.51	13.0	2,500	17.2	4	100.0	28	0.13	0.20	91N
919U-8	13/32	10.4	0.61	15.5	2,000	13.8	5	127.0	28	0.15	0.22	91N
919U-12	5/8	16	0.84	21.4	1,200	8.3	7-1/2	191.0	12	0.22	0.33	91N
919U-16	7/8	22	1.12	28.5	1,000	6.9	9	229.0	14	0.31	0.47	91N



WARNING

This product can expose you to chemicals including Tetrafluoroethylene, which is known to the State of California to cause cancer. For more information go to www.P65Warnings.ca.gov.

929/929B - Heavy Wall SAE 100R14 PTFE Hose

PTFE Core Tube

Enhanced resistance to gas permeation due to increased PTFE wall thickness (.040").



Features

- Excellent kink resistance
- Enhanced resistance to gas permeation due to increased PTFE wall thickness (.040")
- Excellent chemical compatibility
- Handles extreme temperatures to 450°F

Construction

- Tube: 929 - Natural FDA Compliant PTFE
929B - Black Static-Dissipative PTFE
- Reinforcement: 304 Stainless Steel Braid

Operating Parameters

- Temperature Range:
-100°F (-73°C) to 450°F (232°C)
- Change in length at Max. Working Pressure: +2% to -4%
- Min. Burst Pressure is 4x Max. Working Pressure at 73°F (23°C)

Compliance

- Meets/Exceeds SAE J517 100R14A - 929
- Meets/Exceeds SAE J517 100R14B - 929B
- FDA CFR21 Part 177 compliant core - 929

Fittings

- 91N Series – pg. E-52
- For most Parker products, Crimp Die Selection charts are found online at www.parker.com/crimpsource
- Access instructions are on pg. G-3

Notes

- Use hose type 929B with static-dissipative core tube when conveying non-conducting fluids such as oils, paints, fuels, steam, etc.
- Constructed with minimum .040" PTFE tube wall thickness

Series 929/929B

[Visit the webpage](#)

Part Number		Nominal I.D.		Maximum O.D.		Maximum Working Pressure		Minimum Bend Radius		Vacuum Rating	Weight		Permanent Fitting Series
Natural	Static-Dissipative	inch	mm	inch	mm	psi	MPa	inch	mm	Hg/73F	lbs./ft.	kg/mtr	
929-4	929B-4	3/16	5	0.34	8.6	3,000	20.7	2	51.0	28	0.08	0.12	91N
929-6	929B-6	5/16	8	0.47	11.9	2,500	17.2	4	102.0	28	0.12	0.18	91N
929-8	929B-8	13/32	10.4	0.59	15.0	2,000	13.8	4-5/8	117.0	28	0.16	0.23	91N
-	929B-12	1/2	16	0.75	19.1	1,200	8.3	6-1/2	165.0	12	0.19	0.28	91N
-	929B-16	7/8	22	1.14	29.0	1,250	8.6	7-1/2	188.0	12	0.49	0.73	91N



WARNING

This product can expose you to chemicals including Tetrafluoroethylene, which is known to the State of California to cause cancer. For more information go to www.P65Warnings.ca.gov.

929BJ - Silicone Covered SAE 100R14 PTFE Hose

PTFE Core Tube

Silicone cover protects SS wire reinforcement against wear and fraying, up to 450°F.



Features

- Silicone cover protects SS wire reinforcement against wear and fraying, up to 450°F
- Silicone cover provides clean, smooth cover and prevents contaminants from accumulating in braid
- Excellent kink resistance
- Enhanced resistance to gas permeation due to increased PTFE wall thickness
- Steam cleanable

Construction

- Tube: Black Static-Dissipative PTFE
- Reinforcement: 304 Stainless Steel Braid
- Cover: Silicone

Operating Parameters

- Temperature Range: -65°F (-54°C) to 450°F (232°C)
- Change in length at Max. Working Pressure: +2% to -4%
- Min. Burst Pressure is 4x Max. Working Pressure at 73°F (23°C)

Compliance

- Meets/Exceeds SAE J517 100R14B

Fittings

- 91N Series – pg. E-52
- For most Parker products, Crimp Die Selection charts are found online at www.parker.com/crimpsource
- Access instructions are on pg. G-3

Notes

- Cover must be skived prior to fitting attachment
- Constructed with minimum .040" PTFE tube wall thickness

Color

- ● Brown

Series 929BJ

[Visit the webpage](#)

Part Number	Nominal I.D.		Maximum O.D.		Maximum Working Pressure		Minimum Bend Radius		Vacuum Rating Hg/73F	Weight		Permanent Fitting Series	
	Natural	inch	mm	inch	mm	psi	MPa	inch		mm	lbs./ft.		kg/mtr
929BJ-4	3/16		5	0.58	14.7	3,000	20.7	2	51.0	28	0.17	0.25	91N
929BJ-6	5/16		8	0.70	17.8	2,500	17.2	4	102.0	28	0.23	0.34	91N
929BJ-8	13/32		10.4	0.81	20.6	2,000	13.8	4-5/8	117.0	28	0.29	0.43	91N
929BJ-12	5/8		16	1.04	26.4	1,200	8.3	6-1/2	165.0	12	0.43	0.64	91N
929BJ-16	7/8		22	1.36	34.5	1,250	8.6	7-1/2	188.0	12	0.78	1.16	91N



WARNING

This product can expose you to chemicals including Tetrafluoroethylene, which is known to the State of California to cause cancer. For more information go to www.P65Warnings.ca.gov.

939/939B – Convoluted PTFE Hose

PTFE Core Tube

Up to 50% tighter bend radius than smoothbore PTFE hose.



Features

- Excellent flexibility for tighter routings
- Excellent kink resistance

Compliance

- FDA CFR21 Part 177 compliant core - 939

Construction

- Tube: 939 - Natural FDA Compliant PTFE
939B - Black Static-Dissipative PTFE
- Reinforcement: 304 Stainless Steel Braid

Fittings

- 93N Series – pg. E-62
- For most Parker products, Crimp Die Selection charts are found online at www.parker.com/crimpsource
- Access instructions are on pg. G-3

Operating Parameters

- Temperature Range:
-100°F (-73°C) to 450°F (232°C)
- Change in length at Max. Working Pressure: +/-2%
- Min. Burst Pressure is 4x Max. Working Pressure at 73°F (23°C)

Notes

- Use hose type 939B with static-dissipative core tube when conveying non-conducting fluids such as paints, fuels, steam, etc.
- *28 in/Hg can be obtained by using an internal spring guard See pg. F-20

Series 939J/939BJ

[Visit the webpage](#)

Part Number		Nominal I.D.		Maximum O.D.		Maximum Working Pressure		Minimum Bend Radius		Vacuum Rating	Weight		Permanent Fitting Series
Natural	Static-Dissipative	inch	mm	inch	mm	psi	MPa	inch	mm	Hg/73F	lbs./ft.	kg/mtr	
939-6	939B-6	3/8	10	0.59	15.0	1500	10.3	2-1/4	57.0	28	0.12	0.18	93N
939-8	939B-8	1/2	12.5	0.79	20.1	1350	9.3	2-7/8	73.0	28	0.21	0.31	93N
939-10	939B-10	5/8	16	0.88	22.4	1000	6.9	3	76.0	28	0.24	0.36	93N
939-12	939B-12	3/4	19	1.09	27.7	1100	7.6	3-3/4	95.0	28	0.32	0.47	93N
939-16	939B-16	1	25	1.33	33.8	1000	6.9	5	127.0	28	0.45	0.67	93N
939-20	939B-20	1-1/4	31.5	1.75	44.5	1000	6.9	6-1/4	159.0	20*	0.70	1.04	93N
939-24	939B-24	1-1/2	38	2.05	52.1	750	5.2	7-1/2	191.0	12*	0.80	1.18	93N
939-32	939B-32	2	51	2.56	65.0	250	1.7	10	254.0	5*	1.01	1.50	93N



WARNING

This product can expose you to chemicals including Tetrafluoroethylene, which is known to the State of California to cause cancer. For more information go to www.P65Warnings.ca.gov.

944B - High Pressure PTFE Hose

Static Dissipative PTFE Core Tube

Up to 4,500 working pressure.
Low friction minimizes pressure drops.

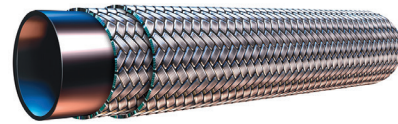

Features

- Excellent chemical compatibility
- Resists moisture
- Low friction minimizes pressure drops and deposits

Construction

- Tube: Black Static-Dissipative PTFE
- Reinforcement: 304 Stainless Steel Braid

Fittings

- 94 Series - pg. E-64

Operating Parameters

- Temperature Range:
-65°F (-54°C) to 400°F (204°C)
- Change in length at Max. Working Pressure: +/-2%
- Min. Burst Pressure is 3x Max. Working Pressure at 73F (23C)

Notes

- Factory made assemblies only
- Reduce pressure to 3000 psi (20.7 MPa) for pressure impulse applications

Series 944B

[Visit the webpage](#)

Part Number	Nominal I.D.		Maximum O.D.		Maximum Working Pressure		Minimum Bend Radius		Vacuum Rating	Weight	
	inch	mm	inch	mm	psi	MPa	inch	mm	Hg/73F	lbs./ft.	kg/mtr
944B-6	5/16	8	0.49	12.5	4,500	31.0	2-1/2	63.5	28	0.17	0.24
944B-8	7/16	10.4	0.62	15.6	4,500	31.0	2-7/8	73.2	28	0.25	0.35
944B-10	1/2	12.5	0.73	18.5	4,000	27.6	3-1/4	82.6	28	0.31	0.45
944B-12	5/8	16	0.99	25.1	4,000	27.6	4	101.6	28	0.74	1.05
944B-16	29/32	22	1.25	31.8	4,000	27.6	5	127.0	28	1.09	1.55



WARNING

This product can expose you to chemicals including Tetrafluoroethylene, which is known to the State of California to cause cancer. For more information go to www.P65Warnings.ca.gov.

955B – High Pressure PTFE Hose

Static Dissipative PTFE Core Tube

5,500 constant working pressure.
Low friction minimizes pressure drops.



Features

- Excellent chemical compatibility
- Resists moisture
- Low friction minimizes pressure drops and deposits

Construction

- Tube: Black Static-Dissipative PTFE
- Reinforcement: Multiple high density braids of 304 Stainless Steel

Fittings

- 95 Series – pg. E-64

Operating Parameters

- Temperature Range:
-65°F (-54°C) to 400°F (204°C)
- Change in length at Max. Working Pressure: +/-2%
- Min. Burst Pressure is 16,000 psi at 73F (23C)

Notes

- Factory-made assemblies only
- Reduce pressure to 4,000 psi (27.6 MPa) for pressure impulse applications

Series 955B

[Visit the webpage](#)

Part Number	Nominal I.D.		Maximum O.D.		Maximum Working Pressure		Minimum Bend Radius		Vacuum Rating	Weight	
	Natural	inch	mm	inch	mm	psi	MPa	inch	mm	Hg/73F	lbs./ft.
955B-4	15/64	6	0.50	12.7	5,500	37.9	3	76.0	28	0.23	0.34
955B-6	5/16	8	0.62	15.7	5,500	37.9	5	127.0	28	0.24	0.35
955B-8	7/16	11.1	0.75	19.1	5,500	37.9	5-3/4	146.0	28	0.46	0.68
955B-10	1/2	12.7	0.91	23.1	5,500	37.9	6-1/2	165.0	28	0.91	1.34
955B-12	5/8	16	1.08	27.4	5,500	37.9	7-3/4	197.0	28	0.92	1.36
955B-16	29/32	23	1.36	34.5	5,500	37.9	9-5/8	245.0	28	1.20	1.77



WARNING

This product can expose you to chemicals including Tetrafluoroethylene, which is known to the State of California to cause cancer. For more information go to www.P65Warnings.ca.gov.

STW/STB True Bore PTFE Hose

PTFE Core Tube

Features a larger I.D. than the equivalent SAE J517, 100R14 PTFE hose.



Features

- High temperature hose
- Excellent chemical compatibility
- Resists moisture
- Low friction minimizes pressure drops and deposits

Construction

- Tube: STW - Natural FDA Compliant PTFE
STB - Black Static-Dissipative PTFE
- Reinforcement: 304 Stainless Steel Braid

Operating Parameters

- Temperature Range:
-100°F (-73°C) to 450°F (232°C)
- Change in length at Max. Working Pressure: +2% to -4%
- Min. Burst Pressure is 4x Max. Working Pressure at 73°F (23°C)
- Pressure ratings based on 73°F (23°C) - Decrease working pressure 1% for every 2°F above 212°F

Compliance

- FDA CFR21 Part 177 compliant core - STW
- USP Class VI
- ISO 10993 Sections 5, 6, 10, 11

Fittings

- PAGE Fittings – pg. E-65
- Uses crimp collar ST300, see pg. E-66
- For most Parker products, Crimp Die Selection charts are found online at www.parker.com/crimpsource
- Access instructions are on pg. G-3

Notes

- "Z" indicates double braid
- See pg. A-21 for part numbering system
- Cannot be used with 90 or 91N series fittings

Series STW/STB

[Visit the webpage](#)

Part Number		Nominal I.D.		Maximum O.D.		Max. Working Pressure 73°F/23°C		Minimum Bend Radius		Vacuum Rating	Weight		Permanent Fitting Series
Natural	Static-Dissipative	inch	mm	inch	mm	psi	MPa	inch	mm	Hg/73F	lbs./ft.	kg/mtr	
04-STW	04-STB	1/4	6	.37	9	3,000	207	3	76	28	.08	.13	PAGE
06-STW	06-STB	3/8	10	.51	13	2,000	138	5	127	28	.11	.16	PAGE
08-STW	08-STB	1/2	13	.63	16	1,750	121	6-1/2	165	28	.16	.24	PAGE
12-STW	12-STB	3/4	19	.88	22	1,000	69	8.5	216	28	.20	.30	PAGE
16-STW	16-STB	1	25	1.13	29	1,000	69	12	305	20	.33	.49	PAGE
20Z-STW	20Z-STB	1-1/4	31.8	1.52	38.6	1,000	69	14	356	18	.68	1.02	PAGE
24Z-STW	24Z-STB	1-1/2	38.1	1.73	43.9	900	62	15	381	15	.79	1.18	PAGE



WARNING

This product can expose you to chemicals including Tetrafluoroethylene, which is known to the State of California to cause cancer. For more information go to www.P65Warnings.ca.gov.

SCW/SCB – Convoluted PTFE Hose, 316 Stainless Braid

PTFE Core Tube

Features extreme flexibility with 316 stainless steel braid reinforcement.



Features

- Excellent corrosion resistance
- Seamless
- Open pitch
- Self draining
- Environmentally safe; low effusion

Construction

- Tube: SCW - Natural FDA Compliant PTFE
SCB - Black Static-Dissipative PTFE
- Reinforcement: 316 Stainless Steel Braid

Operating Parameters

- Temperature Range:
-100°F (-73°C) to 500°F (260°C)
- Change in length at Max. Working Pressure: +2% to -4%
- Min. Burst Pressure is 4x Max. Working Pressure at 73°F (23°C)
- Pressure ratings based on 73°F (23°C)
- Decrease working pressure 1% for every 2°F above 212°F

Compliance

- FDA CFR21 Part 177 compliant core - SCW
- USP Class VI
- ISO 10993 Sections 5, 6, 10, 11

Fittings

- PAGE Fittings – pg. E-65
- Uses crimp collar SC300, see pg. E-66
- For most Parker products, Crimp Die Selection charts are found online at www.parker.com/crimpsource
- Access instructions are on pg. G-3

Notes

- See pg. A-21 for part numbering system
- Cannot be used with 93N series fittings

Series SCW/SCB

[Visit the webpage](#)

Part Number		Nominal I.D.		Maximum O.D.		Max. Working Pressure 73°F/ 23°C		Minimum Bend Radius		Vacuum Rating	Weight		Permanent Fitting Series
Natural	Static-Dissipative	inch	mm	inch	mm	psi	MPa	inch	mm	Hg/73F	lbs./ft.	kg/mtr	
04-SCW	04-SCB	1/4	6.4	0.46	11.7	1,500	10.3	3/4	19.0	28	0.08	0.11	PAGE
06-SCW	06-SCB	3/8	9.5	0.56	14.2	1,500	10.3	1	25.0	28	0.10	0.15	PAGE
08-SCW	08-SCB	1/2	12.7	0.76	19.3	1,500	10.3	1-1/2	38.0	28	0.16	0.23	PAGE
12-SCW	12-SCB	3/4	19.1	1.03	26.2	1,200	8.3	2	51.0	28	0.27	0.40	PAGE
16-SCW	16-SCB	1	25.4	1.34	34.0	1,000	6.9	2-1/2	64.0	28	0.37	0.55	PAGE
20-SCW	20-SCB	1-1/4	31.8	1.75	44.5	750	5.2	3	76.0	28	0.46	0.68	PAGE
24-SCW	24-SCB	1-1/2	38.1	1.95	49.5	650	4.5	3-3/4	95.0	28	0.55	0.81	PAGE
32-SCW	32-SCB	2	50.8	2.45	62.2	450	3.1	4-3/4	121.0	28	0.90	1.40	PAGE



WARNING

This product can expose you to chemicals including Tetrafluoroethylene, which is known to the State of California to cause cancer. For more information go to www.P65Warnings.ca.gov.

SCWV/SCBV Heavy Wall Convoluted PTFE Hose

PTFE Core Tube

Thicker wall handles vacuum applications at elevated temperatures.



Features

- Thicker wall - up to 33% more PTFE than SCW
- Handles vacuum applications at elevated temperatures
- Flare-Seal fittings - Continuous PTFE through the fitting, no area for material entrapment and increased flow
- Excellent chemical compatibility
- Easy Cleaning



Flare-Seal

Construction

- Tube: SCWV - Natural FDA Compliant PTFE
SCBV - Black Static-Dissipative PTFE
- Reinforcement: 316 Stainless Steel Braid

Compliance

- FDA CFR21 Part 177 compliant core - SCWV
- USP Class VI
- ISO 10993 Sections 5, 6, 10, 11

Fittings

- PAGE Fittings – pg. E-65

Operating Parameters

- Temperature Range:
-100°F (-73°C) to 500°F (260°C)
- Change in length at Max. Working Pressure: +2% to -4%
- Min. Burst Pressure is 4x Max. Working Pressure at 73°F (23°C)
- Pressure ratings based on 73°F (23°C)
- Decrease working pressure 1% for every 2°F above 212°F

Notes

- Factory-made assemblies only
- See pg. A-21 for part numbering system
- **Cannot be used with 93N Series Fittings**
- *Vacuum wire recommended to achieve 28 inch rating

Series SCWV/SCBV

[Visit the webpage](#)

Part Number		Nominal I.D.		Maximum O.D.		Max. Working Pressure 73°F / 23°C		Minimum Bend Radius		Vacuum Rating	Weight	
Natural	Static-Dissipative	inch	mm	inch	mm	psi	MPa	inch	mm	Hg/73F	lbs./ft.	kg/mtr
08-SCWV	08-SCBV	1/2	12.7	0.76	19.3	1,500	10.3	2	51.0	28	0.17	0.26
12-SCWV	12-SCBV	3/4	19.1	1.05	26.6	1,200	8.3	2-3/4	70.0	28	0.33	0.49
16-SCWV	16-SCBV	1	25.4	1.27	32.2	1,000	6.9	4	102.0	28	0.37	0.55
20-SCWV	20-SCBV	1-1/4	31.8	1.67	42.4	750	5.2	5-1/2	140.0	28	0.56	0.83
24-SCWV	24-SCBV	1-1/2	38.1	1.94	49.2	650	4.5	7	178.0	28	0.64	0.95
32-SCWV	32-SCBV	2	50.8	2.49	63.2	450	3.1	8-1/2	216.0	28	0.84	1.24
40-SCWV	40-SCBV	2-1/2	63.5	3.29	83.5	200	1.4	12	305.0	28*	1.52	2.26
48-SCWV	48-SCBV	3	76.2	3.83	97.3	175	1.2	14	356.0	28*	1.82	2.71
64-SCWV	64-SCBV	4	101.6	4.83	122.7	150	1.0	16	406.0	28*	2.10	3.13



WARNING

This product can expose you to chemicals including Tetrafluoroethylene, which is known to the State of California to cause cancer. For more information go to www.P65Warnings.ca.gov.

PCW/PCB – Convoluted PTFE Hose, Polypropylene Braid PTFE Core Tube

Polypropylene adds personal handling safety.



Features

- Excellent corrosion resistance
- Seamless
- Open pitch
- Self draining
- Withstands extreme flexing
- Environmentally safe; low effusion
- Long life expectancy

Construction

- Tube: PCW - Natural FDA Compliant PTFE
PCB - Black Static-Dissipative PTFE
- Reinforcement: Polypropylene Braid

Operating Parameters

- Temperature Range: 0°F (18°C) to 212°F (100°C)
- Change in length at Max. Working Pressure: +2% to -4%
- Min. Burst Pressure is 4x Max. Working Pressure at 73°F (23°C)
- Pressure ratings based on 73°F (23°C)
- Decrease working pressure 1% for every 2°F above 212°F

Compliance

- FDA CFR21 Part 177 compliant core - PCW
- USP Class VI
- ISO 10993 Sections 5, 6, 10, 11

Fittings

- PAGE Fittings – pg. E-65
- Uses crimp collar PC300, see pg. E-66
- For most Parker products, Crimp Die Selection charts are found online at www.parker.com/crimpsource
- Access instructions are on pg. G-3

Notes

- Not suggested for steam-cold water cycling applications
- See pg. A-21 for part numbering system
- Cannot be used with 93N series fittings

Series PCW/PCB

[Visit the webpage](#)

Part Number		Nominal I.D.		Maximum O.D.		Max. Working Pressure 73°F/ 23°C		Minimum Bend Radius		Vacuum Rating	Weight		Permanent Fitting Series
Natural	Static-Dissipative	inch	mm	inch	mm	psi	MPa	inch	mm	Hg/73F	lbs./ft.	kg/mtr	
04-PCW	04-PCB	1/4	6.4	0.55	14.0	350	2.4	3/4	19.0	28	0.03	0.05	PAGE
06-PCW	06-PCB	3/8	9.5	0.64	16.3	350	2.4	1	25.0	28	0.06	0.09	PAGE
08-PCW	08-PCB	1/2	12.7	0.84	21.3	350	2.4	1-1/2	38.0	28	0.15	0.22	PAGE
12-PCW	12-PCB	3/4	19.1	1.15	29.2	350	2.4	2	51.0	28	0.18	0.27	PAGE
16-PCW	16-PCB	1	25.4	1.50	38.1	350	2.4	2-1/2	64.0	28	0.26	0.39	PAGE
20-PCW	20-PCB	1-1/4	31.8	1.92	48.8	350	2.4	3	76.0	28	0.37	0.55	PAGE
24-PCW	24-PCB	1-1/2	38.1	2.12	53.8	350	2.4	3-3/4	95.0	28	0.42	0.63	PAGE
32-PCW	32-PCB	2	50.8	2.65	67.3	350	2.4	4-3/4	121.0	28	0.56	0.83	PAGE



WARNING

This product can expose you to chemicals including Tetrafluoroethylene, which is known to the State of California to cause cancer. For more information go to www.P65Warnings.ca.gov.

NCW/NCB – Convoluted PTFE, Nomex® Braid

PTFE Core Tube

Eliminates RFI issues.



Features

- Very light weight
- Superior flexibility
- Kink and vacuum resistant
- Eliminates RFI issues



Construction

- Tube: NCW - Natural FDA Compliant PTFE
NCB - Black Static-Dissipative PTFE
- Reinforcement: Nomex braid

Operating Parameters

- Temperature Range:
-100°F (-73°C) to 400°F (204°C)
- Change in length at Max. Working Pressure: +2% to -4%
- Min. Burst Pressure is 4x Max. Working Pressure at 73°F (23°C)
- Pressure ratings based on 73°F (23°C)
- Decrease working pressure 1% for every 2°F above 212°F

Compliance

- FDA CFR21 Part 177 compliant core - NCW
- USP Class VI
- ISO 10993 Sections 5, 6, 10, 11

Fittings

- PAGE Fittings – pg. E-65

Notes

- Factory-made assemblies only
- NCB (Static Dissipative) tube I.D. surface only
- NCB Conductive Spec - Must conduct 20 microamps 1000 VDC potential 14" sample
- See pg. A-21 for part numbering system
- **Cannot be used with 93N series fittings**

Color

- ● Green

Series NCW/NCB

[Visit the webpage](#)

Part Number		Nominal I.D.		Maximum O.D.		Max. Working Pressure 73°F/23°C		Minimum Bend Radius		Vacuum Rating	Weight	
Natural	Static-Dissipative	inch	mm	inch	mm	psi	MPa	inch	mm	Hg/73F	lbs./ft.	kg/mtr
04-NCW	04-NCB	1/4	6.4	0.48	12.2	725	5.0	1	25.0	28	0.02	0.03
06-NCW	06-NCB	3/8	10	0.58	14.7	400	2.8	1-1/2	38.0	28	0.06	0.09
08-NCW	08-NCB	1/2	12.5	0.77	19.5	280	1.9	2	51.0	28	0.08	0.12
12-NCW	12-NCB	3/4	19	1.05	26.7	200	1.4	2-1/2	64.0	28	0.14	0.21
16-NCW	16-NCB	1	25	1.33	33.8	200	1.4	4	102.0	28	0.22	0.32

Nomex® is a registered trademark of E. I. du Pont de Nemours and Company.



WARNING

This product can expose you to chemicals including Tetrafluoroethylene, which is known to the State of California to cause cancer. For more information go to www.P65Warnings.ca.gov.

Metal Hose

9A, 9M, 9P

Operates up to 1200°F (648°C).



Features

- Hydroformed or crimp formed annular core tube
- High percentage braid coverage for better life cycle and protection against core damage
- 9A - General Purpose - up to 2,700 psi working pressures
- 9M - Ultra Flexible - Compressed corrugations for increased flexibility, up to 2,700 psi working pressure
- 9P - High Pressure - up to 6,000 psi working pressure, Parker's highest pressure metal hose construction

See [CATALOG 4690MH](#) for technical information

Construction

- Tube: 300 series SS
- Reinforcement: 300 series SS braid: 0, 1 or 2 layers

Operating Parameters

- Temperature Range: -380°F (-228°C) to 1200°F (648°C)

Typical Applications

- Abrasion and over bending – as a protective cover over wires or other hoses to prevent these problems
- Chemical transfer
- Diesel engine exhaust
- Hot oil and lube lines
- Loading/unloading of light oils, gas, and chemicals
- Petrochemical
- Power Gen
 - Connections for the fuel rail to the combustion cans on gas turbine fuel lines
 - Pump connections
- Pulp & Paper
- Solvent and steam lines

- For technical information, download CAT 4690



Multitube[®] Hoses

BOP Bundles, Electro-Hydraulic Umbilicals and Hotlines

Over 750,000 feet of bundles in service.
Over 40 million feet of pilot hose produced.



Features

- Dependability and Experience - Over 30 years of Oil & Gas thermoplastic hose design and engineering experience
- Field Tested - Over 750,000 feet of bundles and over 40 million feet of pilot hose produced for rigs
- Capabilities - BOP umbilical lengths up to 7,000+ ft and 90+ pilot hoses within one umbilical
- Extended Service Life - Compact pilot hose design allows for more spares to be installed in the bundle without increasing the O.D.

**For technical information,
contact customer services.**



BOP Umbilicals with Velocity Hose

- BOP umbilicals are used on offshore drilling rigs to control the subsea BOP stack
- Parker's BOP have a smaller O.D. which means Parker can produce BOP umbilicals with more pilot lines without increasing the O.D. of the umbilical
- Parker umbilicals are built with Velocity Hose to allow for precise control and faster response times when activating subsea valves on the BOP pod



Electro-Hydraulic Umbilicals

- Parker is an industry leader in designing short length electro-hydraulic umbilicals for offshore applications
- Parker high-pressure subsea hoses, [1/4", 3/8" and 1/2" I.D.], are in compliance to API 17e and pressure ratings up to 15,000 psi. These hoses can be combined into an umbilical configuration with electrical power cables included



Hotline Hose

- Subsea Hotline's are the primary emergency hydraulic control line providing critical service for various subsea functions
- Parker Hotline hoses are specially designed to provide fast response time and low volumetric expansion with length capability of 14,000 feet continuous

A Hose

Tubing
Thermoplastic

Coiled Air Hose
& Fittings

Transportation

Fittings

Tooling,
Equipment
& Accessories

General
Technical

polyflex

Ultra-High Pressure Hose

Parker **polyflex** is the originator and continued innovator of UHP hoses.



Features

- Consistent quality through superior design
- Working pressures up to 58,000 psi
- Wide range of hose sizes from 5/64" to 3" I.D.
- Very long continuous lengths available
- Multiple color options for ease of identification
- Wide range of core tube and jacket material options available

See **CATALOG 4900**
for technical information



Ultra High Pressure Hoses

- Parker is the only UHP hose manufacturer with a built in ColorGard™ sheath, giving operators easy visualization of core tube erosion for more efficient product inspections and reduced unscheduled downtime
- Production plants in both the USA and Europe, supported by Parker's global sales and distribution network



Oil & Gas Hose

- Used in a wide variety of onshore and offshore applications
- Available with a seawater resistant cover
- Providing the only multi-color crush resistant oil and gas hose
- Customers benefit from local service and the supply of quality parts wherever they are located



Hydraulic Tool Hose

- Used in power hydraulic tools, such as torque wrenches and bolt tensioners
- They are also used on hydraulic rescue equipment and similar tools

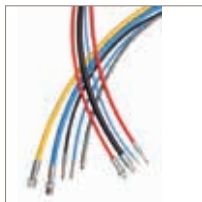

Waterblast Tool Hose

- Developed for high and ultra high pressure applications including cleaning and surface preparation, high pressure tube cleaning, water jet cutting and hydro-demolition
- Up to 20% lighter than competitor hoses
- Available with a TOUGHJACKET™ cover providing 16% more abrasion resistance than PVC and eliminating the bulky, PVC cover
- Color-compliant for improved safety
- ColorGard™ technology for a safer operation



TUBING

Nylon
Polyethylene

Polypropylene
Polyurethane

Vinyl
PTFE

FEP
PFA

Table of Contents

Intro

Material Property Overview.....	B-4	Tubing Compatibility Chart.....	B-8
Materials to Parflex Tubing	B-10	Tubing Specifications	B-6
Media to Plastic Compatibility	B-11	Tubing Pressures	B-7
NOMENCLATURE	B-14		

THERMOPLASTICS

Nylon Tubing

Series N/NB - Flexible	B-27
PAT - Pure Air.....	B-31
Series NR/NBR - Semi-Rigid.....	B-33

Polyethylene Tubing

Series E/EB - Instrument Grade.....	B-20
PEFR - Flame Resistant	B-23
HDPE - High Density.....	B-25

Polypropylene Tubing

Series PP - Laboratory Grade	B-35
------------------------------------	------

Polyurethane Tubing

95U/95UM Polyether Based	B-37
95FR Flame Resistant.....	B-39

Polyvinyl Chloride (Vinyl) Tubing

PV Tubing Instrument Grade	B-41
----------------------------------	------

FLUOROPOLYMERS

Smoothbore Tubing

PTFE.....	B-44
FEP.....	B-66
PFA.....	B-77
HP PFA.....	B-79

Beading

PTFE Beading.....	B-52
-------------------	------

Heat Shrinkable Tubing

PTFE 2:1 Fractional.....	B-56
PTFE 2:1 AWG.....	B-58
PTFE 4:1 Fractional.....	B-61
FEP 1.25/1 Roll Cover.....	B-71
FEP 1.3/1 AWG & Fractional.....	B-69
FEP 1.67/1.....	B-69

Spiral Wrap Tubing

PTFE Spiral Wrap.....	B-54
-----------------------	------

Convuluted Tubing

PTFE Standard Convuluted.....	B-62
PTFE Low Profile.....	B-63
PTFE Heavy Wall.....	B-63
FEP Convuluted.....	B-73
AMS-T-81914/1 or 2.....	B-64
AMS-T-81914/3 or 4.....	B-65

Corrugated Tubing

Corrugated Tubing.....	B-75
------------------------	------



A
Hose

B
Tubing

C
Coiled Air Hose
& Fittings

D
Transportation

E
Fittings

F
Tooling,
Equipment
& Accessories

G
General
Technical

Material Property Overview

Thermoplastic Quick Reference

PE (Polyethylene)

Working Temperature: 150°F (66°C)

Series E/EB

- Chemical resistant
- Economical system solution
- FDA/NSF Compliant
- Resistant to environmental stress cracking

Series PEFR

- Flame resistant
- High strength & excellent flexibility
- Resistant to environmental stress cracking

Series HDPE

- Chemical resistant
- Economical system solution
- Improved burst pressure rating than LLDPE resin
- Working Temperature 175°F (80°C)

PP (Polypropylene)

Working Temperature: 200°F (93°C)

Series PP/PPB

- Acid & chemical resistant
- Low moisture absorption (less than .01%)
- Resistant to environmental stress cracking
- Higher working pressures/temperatures than PE tubing

PU (Polyurethane)

Working Temperature: 180°F (82°C)

Series 95U/95UM

- 95 Shore A durometer
- Excellent abrasion and kink resistance
- Excellent moisture resistance
- UV resistant
- Exhibits the elongation and recovery characteristics of rubber and the chemical resistance of a thermoplastic

Series 95FR

- 95 Shore A durometer
- Weld spatter resistant
- Flame & weld spatter resistant
- Silicone and halogen free
- Excellent flexibility
- Working Temperature 165°F (75°C)

Nylon

Working Temperature: 200°F (93°C)

Series N/NB

- Abrasion resistant
- Flexible
- Heat and light stabilized
- Low moisture absorption
- Chemical resistant

Series PAT

- Chemical resistant
- UV light resistant
- Low moisture absorption
- High tensile strength

Series NR/NBR

- Unplasticized nylon for higher pressure tubing applications
- Chemical resistant
- Low moisture absorption
- High tensile strength

Tubing specifications are located on page B-6

Material Property Overview

Fluoropolymer Quick Reference

PTFE (Polytetrafluoroethylene)

Working Temperature: 500°F (260°C)

Color: Opaque to translucent

- Chemically inert
- Lowest coefficient of friction
- Superior dielectric strength
- Exceptional heat resistance
- Self extinguishing
- Non-wetting
- Excellent flexlife
- Laser markable

PFA (Perfluoroalkoxy)

Working Temperature: 500°F (260°C)

Color: Clear with light blue or tint

- High purity resins available
- Low permeation resins available
- Use when you need the temperature range of PTFE and the clarity of FEP
- Exceptional heat resistance
- Self extinguishing
- Non-wetting
- Good flexlife

FEP (Fluorinated Ethylene Propylene)

Working Temperature: 400°F (204°C)

Color: Clear

- Excellent chemical resistance
- Non-wetting
- Weldable
- Tubes can be sealed by melting
- Long continuous lengths
- Low refractive index
- Improved clarity over PFA
- Lower cost alternative to PFA

Tubing specifications are located on page B-6

Fluoropolymer Chemical Resistance Summary



Within normal use, temperatures, fluoropolymers are attacked by so few chemicals that it is easier to describe the exceptions rather than list the chemicals they are compatible with.

DO NOT USE FLUOROPLASTICS WITH THE FOLLOWING:

- Alkali metals such as elemental sodium, potassium, lithium, etc. The alkali metals remove fluorine from the polymer molecule.
- Extremely potent oxidizers, fluorine (F₂) and related compounds (e.g., chlorine trifluoride, ClF₃). These can be handled by fluoropolymers, but only with great care, as fluorine is absorbed into the resins, and the mixture becomes sensitive to a source of ignition such as impact.
- 80% NaOH (Sodium Hydroxide) or KOH (Potassium Hydroxide), metal hydrides such as Boranes (e.g., B₂H₆), Aluminum Chloride, Ammonia (NH₃), certain Amines (R-NH₂) and imines (R=NH) and 70% Nitric Acid at temperatures near the suggested service limit.



WARNING

FAILURE OR IMPROPER SELECTION OR IMPROPER USE OF THE PRODUCTS AND/OR SYSTEMS DESCRIBED HEREIN OR RELATED ITEMS CAN CAUSE DEATH, PERSONAL INJURY AND PROPERTY DAMAGE.

This document and other information from Parker Hannifin Corporation, its subsidiaries and authorized distributors provide product and/or system options for further investigation by users having technical expertise. It is important that you analyze all aspects of your application and review the information concerning the product or system in the current product catalog. Due to the variety of operating conditions and applications for these products or systems, the user, through its own analysis and testing, is solely responsible for making the final selection of the products and systems and assuring that all performance, safety and warning requirements of the application are met.

The products described herein, including without limitation, product features, specifications, designs, availability and pricing, are subject to change by Parker Hannifin Corporation and its subsidiaries at any time without notice.

Tubing Specifications

Agency Specifications	Tubing Series
Flame Resistance	
UL94V-0	PFA, FEP and PTFE tubing, 95FR Cover
UL94V-2	PEFR
UL94HB	83FR, NN, NB, NNR, NBR (wall thickness above .033" - contact Parflex for availability)
Food Contact	
FDA, CFR21 Part 177	E, PP, PV, All natural and black PFA, FEP and PTFE tubing products
NSF Standard 51*	E, PP
Potable Water	
NSF Standard 61*	E - Tubing
Aerospace Military Specifications	
AMS 3584A	HS2TFI
AMS 3585	HS2TFT
AMS 3586	HS2TFS
AMS 3653E	101, 201, TFS, TFL, TFH, TFT, HS2TFS, HS2TFT, HS2TFL, HS2TFI, TSWTF, CV (PTFE), CVL, CVH, 81914/1, 81914/2
AMS 3655B	TFT
MIL-DTL-27267C	PTFE Conductive Tubing
AMS-T-81914/1	81914/1
AMS-T-81914/1	81914/2
AMS-T-81914/1	81914/3
AMS-T-81914/1	81914/4
American Society for Testing and Materials	
ASTM D2116-07	103, 203
ASTM D2902 TYPE I	HS2TFS, HS2TFT, HS2TFL, HS2TFI, HS2TFH
ASTM D2902 TYPE II	HS1.3FEP, HS1.6FEP, HS1.25FEP
ASTM D3295	TSWTF
ASTM D3295, Class 1	TFL
ASTM D3295, Class 2	TFT
ASTM D3295, Class 3	TFS
ASTM D3295, Class 4	TFH
ASTM D3296-03	HS1.3FEP, HS1.6FEP, CV (FEP), 81914/3, 81914/4, CR (FEP), 703
ASTM D3307-10	104, 204, 105, 205, CR (PFA), 704, 705
Canadian Standards Association	
CSA 9032-01 300V	TFT (awg)
CSA 9032-01 600V	TFS (awg)
Military Standard - US Department of Defense	
MIL-I-22129C	TFS
Underwriters Laboratories	
UL-224 150V 200°C	TFL (awg)
UL-224 300V 200°C	TFT (awg)
UL-224 600V 200°C	TFS (awg)
United States Pharmacopoeia	
USP Class VI	101, 201, TFS, TFL, TFH, TFT, HS2TFS, HS2TFT, HS2TFL, HS2TFI, HS2TFH, CV, CVL, CVH, 103, 203, HS1.3FEP, HS1.6FEP, CR, 104, 204, 105, 205

Tubing Pressures Ranges

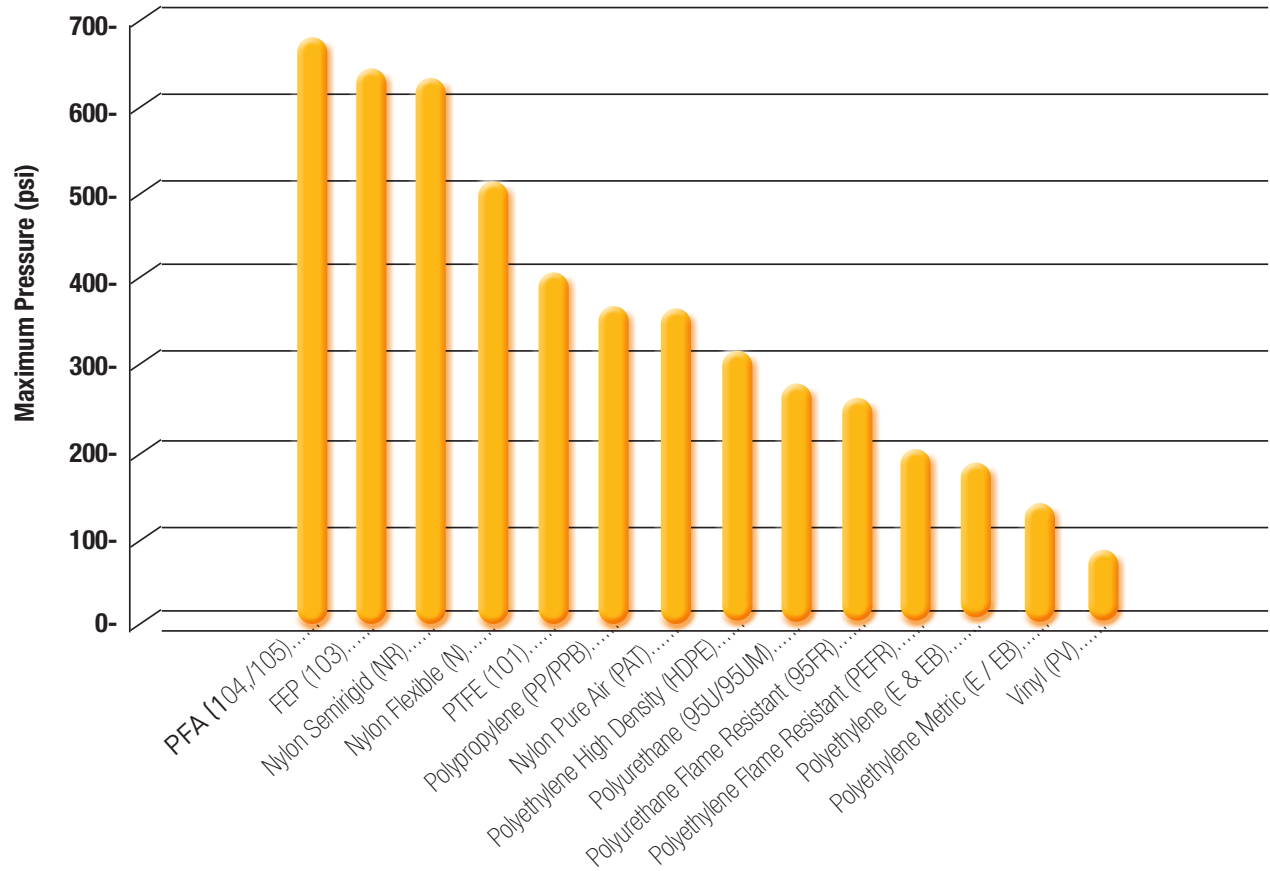

Hose
A

Tubing
B

Coiled Air Hose
& Fittings
C

Transportation
D

Fittings
E

Tooling,
Equipment
& Accessories
F

General
Technical
G

Tubing Compatibility Chart

Tubing/Hose Capability with Parker FSC Fittings

Product Sizes (inch)		Thermoplastic and Thermo-elastomer Tubing									
		Industrial Tubing Series (Outside Diameter (O.D.) Shown)									
		Polyethylene E & EB Inch (4,5,6,8,10) Metric (6,8,10,12)	Polyethylene PEFR Inch (2,5,4,6,8)	Polyethylene HDPE Inch (4,6)	Nylon N Inch (2,2.5,3,4,5,6,8)	Nylon PAT Inch (2,4,6,8,12)	Nylon NR/NBR Inch (2,3,4,5,6,8)	Polypropylene PP & PPB Inch (2,3,4,6,8,10)	Polyurethane 95U & 95UM (90 - 95 Shore A) Inch (2,2.5,4,6,8,12) Metric (4,6,8,10,12)	Polyurethane MicroWeld™ 95FR Inch (4,6,8) Metric (6,8,10,12)	Clear Vinyl Inch (1/8" - 2 1/2")
Compression & Flare	Compression Inch (2,3,4,5,6,7,8,10,12)	PS TS	PS TS	PS TS	PS TS	PS TS	PS TS	PS TS			
	Compress-Align Inch (2,3,4,5,6,8,10,12,14,16)	TS	TS	TS	TS	TS	TS	TS			
	Metric Compression Metric (4,5,6,8,10,12,14,16,18,20,22,25,28)	TS			TS		TS	TS			
	Poly-Tite Inch (4,5,6,8)				BS			BS			
	Hi-Duty Inch (2,3,4,5,6,8,10)	TS	TS	TS	TS	TS	TS	TS			
	45 degree flare Inch (2,3,4,5,6,8,10,12,14)										
	Inverted Flare Inch (2,3,4,5,6,8,10,12)										
	Fast & Tite Inch (4,5,6,8,10)								TS		
Push-to-Connect	Flow Controls Inch (2,2.5,4,5,6,8) Metric (4,6,8,10,12)										
	Prestolok Brass Inch (2,2.5,3,4,5,6,8)										
	Prestolok Composite Inch (2,2.5,3,4,5,6,8,10) Metric (3,4,6,8,10,12,14,16)										
	Prestolok All-Metal Inch (2.5,4,5,6,8) Metric (4,6,8,10,12,14)										
	Prestolok Stainless Inch (2.5,3,4,5,6,8) Metric (4,6,8,10,12)										
	Liquifit Inch (2.5,4,6,8) Metric (4,6,8,10,12)										
	TrueSeal Inch (4,5,6,8)						MG		TS		
Barb	Par-Barb Inch (2,3,4,5,6,8,10,12,16,20,24) Inside Diameter								CL		
	Dubl-Barb Inch (2.5,4,6,8)										
	Hose Barb Inch (2,3,4,5,6,8,10,12,16) Inside Diameter										
	Garden Hose										
DOT Transportation	NTA Inch (3,4,6,8,10,12)										
	Transmission Fittings Inch (2,2.5)										
	Air Brake Inch (4,6,8,10,12,16)										
	Air Brake Hose Inch (6,8)										
	Vibra-Lok Inch (2,3,4,5,6,8,10,12)										
	Brass PTC Inch (4,6,8,10) Metric (6,8,10,12,16)										
	PTC Inch (2.5,3,4,6,8,10,12)										
SAE Cartridges Inch (4,6,8,10)											

Tubing Compatibility Chart for Fittings

Tubing/Hose Capability with Parker FSC Fittings

Thermoplastic Tubing				Fluoropolymer Tubing			Product Sizes (inch)
Transportation Tubing				PFA Fluoropolymer Inch (3/32" - 1") Metric (4mm - 12mm)	FEP Fluoropolymer Inch (1/8" - 1") Metric (3mm - 12mm)	PTFE Fluoropolymer Inch (3/32" - 1") Metric (3mm - 16mm)	
PFT Air-Brake (SAE J844) Inch (2,2.5,3,4,5,6,8,10,12)	Air Brake DIN 74324 (Nylon 12) Metric (4,6,8,10,12,15,16,18)	PFT Diesel Fuel Sizes 4,6,8,10,12	HTFL Diesel Fuel Sizes 4,6,8,10,12				
				PS TS	PS TS	PS TS	Compression Inch (2,3,4,5,6,7,8,10,12)
					TS	TS	Compress-Align Inch (2,3,4,5,6,8,10,12,14,16)
					TS	TS	Metric Compression Metric (4,5,6,8,10,12,14,16,18,20,22,25,28)
							Poly-Tite Inch (4,5,6,8)
							Hi-Duty Inch (2,3,4,5,6,8,10)
							45 degree flare Inch (2,3,4,5,6,8,10,12)
							Inverted Flare Inch (2,3,4,5,6,8,10,12,14)
							Fast & Tite Inch (4,5,6,8,10)
							Flow Controls Inch (2,2.5,4,5,6,8) Metric (4,6,8,10,12)
							Prestolok Brass Inch (2,2.5,3,4,5,6,8)
							Prestolok Composite Inch (2,2.5,3,4,5,6,8,10) Metric (3,4,6,8,10,12,14,16)
							Prestolok All-Metal Inch (2.5,4,5,6,8) Metric (4,6,8,10,12,14)
							Prestolok Stainless Inch (2.5,3,4,5,6,8) Metric (4,6,8,10,12)
							Liquifit Inch (2.5,4,6,8) Metric (4,6,8,10,12)
				MG	MG	MG	TrueSeal Inch (4,5,6,8)
							Par-Barb Inch (2,3,4,5,6,8,10,12,16,20,24) Inside Diameter
							Dubl-Barb Inch (2.5,4,6,8)
							Hose Barb Inch (2,3,4,5,6,8,10,12,16) Inside Diameter
							Garden Hose
							NTA Inch (3,4,6,8,10,12)
							Transmission Fittings Inch (2,2.5)
	TS						Air Brake Inch (4,6,8,10,12,16)
							Air Brake Hose Inch (6,8)
							Vibra-Lok Inch (2,3,4,5,6,8,10,12)
							Brass PTC Inch (4,6,8,10) Metric (6,8,10,12,16)
							PTC Inch (2.5,3,4,6,8,10,12)
							SAE Cartridges Inch (4,6,8,10)

Tube Line Fabrication Guide for Leak Free Systems

Every hydraulic, pneumatic and lubrication system requires some form of tube line fabrication and fitting installation for completion. Proper fabrication and installation are essential for the overall efficiency, leak free performance, and general appearance of any system.

Start by planning ahead. After sizing the tube lines and selecting the appropriate style of fitting, consider the following in the design of your system:

1. Accessibility of joints
2. Proper routing of lines
3. Adequate tube line supports
4. Available fabricating tools

Compression & Flare

Push-to-Connect

Barb

DOT Transportation

- PS** Plastic Sleeve & Tube Support Recommended
- TS** Tube Support Is Recommended
- BS** Brass Sleeve Recommended
- CL** Clamp Required
- MG** Metal Gripper Collet Recommended
- ☐** Tube/Fitting Combination Compatible
- ☐** Tube/Fitting Combination NOT Compatible

For technical information, download FSC CAT 3501



Materials to Parflex Tubing

Materials to Parflex Thermoplastic Tubing

Material Code for Tubing Core Tubes	Material Name	Tubing
HDPE	High Density Polyethylene	HDPE
N	Flexible Nylon	N
NR	Unplasticized Nylon (semi-rigid)	NR
PE	Linear Low Density Polyethylene	E
PEFR	Flame Resistant Polyethylene	PEFR
PP	Polypropylene	PP
PV	Flexible Polyvinyl Chloride (PVC)	PV
U	Polyurethane	95U/95UM, 95FR/95FRM

Materials to Parflex Fluoropolymer Tubing

Material Code for Tubing Core Tubes	Material Name	Tubing
FEP	Fluorinated Ethylene Propylene	103, 203, HS1.3FEP, HS1.6FEP, CV03, CR03, 81914/3, 81914/4
PFA	Perfluoroalkoxy	104, 204, 105, 205, CV04, CR04, 704, 705
PTFE	Polytetrafluoroethylene	AWG TFL, AWG TFS, AWG TFT, AWG TFH, 101, 201, HS2TFS, HS2TFT, HS2TFL, HS2TFI, HS4TFI, CV01, CVL, CVH, 81914/1, 81914/2

Rating Codes:

- G Good to excellent. Little or no swelling, tensile or surface changes. Preferred choice.
- L Marginal or conditional. Noticeable effects but not necessarily indicating lack of serviceability. Further testing suggested for specific application. Very long-term effects such as stiffening or potential for crazing should be evaluated.
- P Poor or unsatisfactory. Not recommended without extensive and realistic testing.
- — Indicates that this was not tested.
- # For fluoropolymer. Indicates good chemical resistance but potential for excessive permeation.
- 2 See notes pg. B-13.
- 5 See notes pg. B-13.
- 6 See notes pg. B-13.

Media to Plastic Tubing Material Compatibility Guide

Hose
A

Media to Plastic Tubing Material

Media	PE	HDPE	PP	N	NR	PV	U	PEFR	FEP	PFA	PTFE
Acetone	P	L	G	G	G	P	P	L	G	G	G
Acetyl Bromide	L	L	L	P	P	P	-	-	-	-	-
Acetyl Chloride	L	L	L	P	P	P	-	-	G	G	G
Air	G	G	G	G	G	G	G	G	G	G	G
Alcohols	G	G	G	G	G	L	L	G	G	G	G
Aluminum Salts	G	G	G	G	G	G	G	G	-	-	-
Ammonia	G	G	G	G	G	G	G	L	-	-	-
Amyl Acetate	G	G	G	G	G	P	L	-	G	G	G
Aniline	L	G	L	P	P	P	P	-	G	G	G
Animal Oils (6)	P	L	L	G	G	G	G	-	-	-	G
Arsenic Salts	G	G	G	G	G	G	G	G	-	-	-
Aromatic Hydrocarbons	P	L	L	G	G	P	L	P	-	-	G
Barium Salts	G	G	G	G	G	G	G	G	-	-	-
Benzaldehyde	P	L	L	L	L	P	L	P	G	G	G
Benzene	P	L	L	G	G	P	L	P	G	G	G
Benzyl Alcohol	P	G	L	L	L	G	L	P	G	G	G
Bleaching Liquors	G	L	G	L	L	L	L	-	-	-	-
Boric Acid Solutions	G	G	G	G	G	G	G	G	G	G	G
Bromine	L	L	P	P	P	P	P	-	G	L	G
Butane (2)	L	G	G	G	G	L	P	-	#	#	#
Butanol	G	G	G	G	G	G	G	G	-	-	-
Butyl Acetate	G	G	L	G	G	P	L	G	G	G	G
Calcium Hypochlorite	L	L	P	P	L	L	P	L	G	G	G
Calcium Salts	G	G	G	G	G	G	G	G	-	-	-
Carbon Dioxide	G	G	G	G	G	G	G	G	#	#	#
Carbon Disulfide	L	L	L	L	L	P	L	-	#	#	#
Carbon Tetrachloride	P	P	L	L	L	L	P	P	G	G	G
Caustic Potash	G	G	G	G	G	L	G	-	G	G	G
Caustic Soda	G	G	G	G	G	L	G	-	G	L	G
Chloroacetic Acid	L	G	L	L	L	P	P	-	G	L	G
Chlorine (Dry)	L	L	L	P	P	G	P	-	#	#	#
Chlorine (Wet)	L	L	L	P	P	G	L	-	G	G	G
Chlorobenzene	P	L	L	L	L	P	L	P	G	G	G
Chloroform	P	L	P	P	P	P	P	P	G	G	G
Chromic Acid	L	L	L	P	P	G	P	-	L	G	G
Copper Salts	G	G	G	G	G	G	G	G	-	-	-
Cresol	P	L	L	P	P	L	P	P	G	G	G
Cyclohexanone	L	L	L	L	L	P	P	-	G	G	G
Ethers	L	L	P	G	G	L	P	-	G	G	G
Ethyl Acetate	G	G	G	G	G	P	L	-	G	G	G
Ethyl Alcohol	G	G	G	L	L	L	G	G	-	-	-
Ethylamine	L	G	L	L	L	P	L	-	-	-	-
Ethyl Bromide	P	L	L	L	L	P	-	P	-	-	-
Ethyl Chloride	P	L	P	L	L	P	-	P	G	G	G
Fatty Acids	L	L	L	G	G	L	L	P	G	G	G

Tubing
B

Coiled Air Hose
& Fittings
C

Transportation
D

Fittings
E

Tooling,
Equipment
& Accessories
F

General
Technical
G

Rating Code - pg. B-10
Notes - pg. B-13

(Cont.)

Media to Plastic Tubing Material Compatibility Guide

Media to Plastic Tubing Material

Media	PE	HDPE	PP	N	NR	PV	U	PEFR	FEP	PFA	PTFE
Ferric Salts	G	G	G	G	G	G	G	-	-	-	-
Formaldehyde	G	G	G	L	L	L	P	-	G	G	G
Formic Acid	G	G	G	P	P	G	P	G	G	G	G
Freon	L	L	L	G	G	P	L	-	#	#	#
Gasoline (2)	P	G	L	G	G	P	L	P	G	G	G
Glucose	G	G	G	G	G	G	G	G	G	G	G
Glycerin	G	G	G	G	G	G	L	G	G	G	G
Hydriodic Acid	L	G	G	P	P	G	-	-	-	-	-
Hydrochloric Acid. (Conc.)	L	G	G	L	L	L	P	-	G	L	G
Hydrochloric Acid. (Med. Conc.)	L	G	G	L	L	L	P	-	G	L	G
Hydrofluoric Acid	L	L	G	P	P	L	P	-	G	-	G
Hydrogen Peroxide (Conc.)	L	G	L	L	L	L	G	-	-	-	-
Hydrogen Peroxide (Dil.)	L	G	L	G	G	G	G	-	-	-	-
Hydrogen Sulfide	G	G	G	G	G	G	P	-	G	G	G
Iodine	L	G	G	G	G	L	L	-	G	G	G
Kerosene (2)	L	L	L	G	G	L	L	-	G	G	G
Ketones	G	G	G	G	G	P	P	-	G	G	G
Lacquer Solvents	L	L	L	G	G	P	-	-	L	G	G
Lactic Acid	G	G	G	G	G	G	G	-	G	G	G
Lead Acetate	G	G	G	G	G	G	G	-	G	G	G
Linseed Oil	L	G	G	G	G	L	G	-	G	G	G
Magnesium Salts	G	G	G	G	G	G	G	-	-	-	G
Naphtha	L	L	L	G	G	P	L	G	G	G	G
Natural Gas	L	L	L	G	G	G	G	-	(2)	(2)	(2)
Nickel Salts	G	G	G	G	G	G	G	-	-	-	-
Nitric Acid (Conc.)	P	L	P	P	P	L	P	G	L	L	G
Nitric Acid (Dil.)	P	G	L	L	L	G	P	P	L	L	G
Nitrobenzene	P	L	G	L	L	P	P	P	G	G	G
Nitrogen Oxides	L	L	G	L	L	G	-	-	-	-	-
Nitrous Acid	L	L	G	L	L	G	L	-	G	G	G
Oils (Animal and Mineral)	L	L	L	G	G	L	G	-	G	G	G
Oils (Vegetable)	L	L	L	G	G	L	G	-	G	G	G
Oxygen (5) (6)	G	G	G	G	G	G	G	G	G	G	G
Perchloric Acid	P	G	L	P	P	L	P	P	L	G	G
Phenols	P	G	G	P	P	L	P	P	-	-	G
Potassium Salts	G	G	G	G	G	G	G	G	-	-	-
Pyridine	L	L	L	L	L	P	P	-	G	G	G
Silver Nitrate	G	G	G	G	G	G	G	G	G	G	G
Soap Solutions	G	G	G	G	G	G	G	G	G	G	G
Sodium Salts	G	G	G	G	G	G	G	G	-	-	-
Stearic Acid	L	L	L	G	G	P	L	-	G	G	G
Sulfur Chloride	L	L	P	L	L	L	-	-	G	G	G
Sulfuris Acid (Conc.)	P	G	G	P	P	L	P	P	-	-	-
Sulfuris Acid (Dil.)	P	G	G	L	L	G	L	P	-	-	-
Sulfurous Acid	P	G	L	L	L	G	L	P	G	G	G

Rating Code - pg. B-10
Notes - pg. B-13

[Cont.]

Media to Plastic Tubing Material Compatibility Guide

Media to Plastic Tubing Material

Media	PE	HDPE	PP	N	NR	PV	U	PEFR	FEP	PFA	PTFE
Tannic Acid	G	G	G	G	G	G	P	-	G	G	G
Tanning Extracts	G	G	G	G	G	G	P	-	-	-	-
Titanium Salts	G	G	G	G	G	G	G	G	-	-	-
Toluene	P	L	P	G	G	P	L	P	G	G	G
Trichloroacetic Acid	L	L	L	P	P	P	P	-	-	-	-
Trichloroethylene	P	L	P	L	L	P	P	P	G	G	G
Turpentine	P	P	L	G	G	L	L	-	G	G	G
Urea	G	G	G	G	G	G	G	-	G	L	G
Uric Acid	G	G	G	G	G	G	G	-	G	G	G
Water (6)	G	G	G	G	G	G	G	G	G	G	G
Water / Glycol Mixture	G	G	G	G	G	G	G	G	G	G	G
Xylene	P	L	P	G	G	P	P	P	G	G	G
Zinc Chloride	G	G	G	G	G	G	G	-	G	L	G

Rating Code - pg. B-10

Notes:

The Fluid Compatibility Guides are simplified rating tabulations based on immersion tests at 75°F. Higher temperatures tend to reduce ratings. Since final selection depends on pressure, fluid and ambient temperature and other factors not known to Parker Hannifin Co., no performance guarantee is expressed or implied. Ratings do not imply compliance with specialized codes such as FDA, NSF, AGA or UL and do not cover possible fluid discoloration, taste or odor effects. For conveying foodstuffs, use FDA sanctioned materials and for potable water, use NSF listed materials. For chemicals not listed, or for advice on particular applications, please consult Product Engineering, Parflex Div., Ravenna, Ohio,

- (2) Tubing applications for these fluids must take into account legal and insurance regulations. This does not imply AGA or UL compliance.
- (5) Chemical compatibility does not imply low permeation rates. Consult the Parker factory for a suggestion for your specific requirement.
- (6) Does not imply NSF or FDA compliance.
- Chemical compatibility does not imply acceptability for use in airless paint spray applications. These applications require a special conductive tube.

Nomenclature Thermoplastic Tubing

Nylon & Polyurethane: Series N, NR, PAT, 95U, 95UM, 95FR



Product Family	Tube Size O.D.	Tube Wall Thickness	Tubing Color Nylon*	Tubing Color Polyurethane
Nylon	See Selection Charts	See Selection Charts	See Selection Charts	See Selection Charts
NN = Nylon	Imperial	Imperial	NN = Natural	Blank = Natural
NB = Nylon, Black	2 = .125	Example	NB = Black	BLK = Black
PAT = Nylon, Pure Air Tubing*	2.5 = .156	016 = .016	BLU = Blue	BLU = Blue
NBR - Nylon, Semi-rigid black	3 = .188	124 = .124	GRN = Green	GRA = Gray
NNR - Nylon, Semi-rigid	4 = .250		RED = Red	GRN = Green
	5 = .313	Metric Example	YEL = Yellow	RED = Red
Polyurethane	6 = .375	.65 = .65 mm	Note: Parflex standard color is natural	WHT = White
95U = Polyurethane, 95 Durometer	8 = .500	14 = 14 mm		YEL = Yellow
95UM = Polyurethane, 95 Durometer, Metric	10 = .625			TBL = Transparent Blue
95FR = Polyurethane, MicroWeld	12 = .750			TGN = Transparent Green
Flame Resistant				TRD = Transparent Red
95FRM = Polyurethane, MicroWeld	Metric Example			TYL = Transparent Yellow
Flame Resistant, Metric	.65 = .65 mm			Note: Parflex standard color is natural
	14 = 14 mm			

Tubing Packaging**

- See Selection Charts
- 0100 = 100 ft coil
- 0250 = 250 ft coil
- 0500 = 500 ft coil
- 1000 = 1000 ft coil

*Note: PAT Tubing
Does not have a "-" between the product family and the tube O.D.
Does not have a wall thickness listed.
Has special colors not available in other series BRN = Brown, SIL = Silver, BLK = Black

**Note: Nylon Tubing
Standard 250' package has no length reference.
Contact Parflex Division for additional size/color options.

Example: N-4-035-Red

- N-4-035-Red- Nylon**
- N-4-035-Red- **Tube O.D.** in sixteenths of an inch (**1/4"**)
- N-4-**035**-Red- **Wall Thickness** in inches (**.035"**)
- N-4-035-Red- **Color**, i.e. **Red** (Omit for Natural and Black)
- NN**-4-035-EZ - 100 ft box, Natural Nylon
- NB**-4-035-0100 - Black Nylon
- N-4-035-**Red**- **Package Quantity** in feet (**250'**)

Standard 250' package has no length reference.
Add -EZ for 100' boxed coil (NB-4-035-EZ)

Example: 95UM-6x1-BLK-0100

- 95UM-6x1-BLK-0100 - 95 Durometer Polyurethane**
- 95UM-**6**x1-BLK-0100 - **Tube O.D.** in millimeters (**6mm**)
- 95UM-6x**1**-BLK-0100 - **Tube I.D.** in millimeters (**1mm**)
- 95UM-6x1-**BLK**-0100 - **Color Black** (Omit for Natural)
- 95UM-6x1-BLK-**0100** - **Package Quantity** in feet (**100'**)

Nomenclature

Thermoplastic Tubing

Polyethylene, Polypropylene & Vinyl: Series E, EB, PEFR, HDPE, PP, PPB, PV



Product Family	Tube Size O.D.	Tube Size I.D.	Tubing Color*	Tubing Packaging	Tubing Configuration
E = Polyethylene	See Selection Charts	See Selection Charts	See Selection Charts	See Selection Charts	See Selection Charts
EB = Polyethylene, Black					
PEFR = Polyethylene, Flame Resistant	Imperial	Imperial	Blank = Natural Blank = Black	Lengths	NSF = NSF Compliant (add to black part number EB)
HDPE = Polyethylene, High Density	2 = .125 2.5 = .156	2 = .125 2.5 = .156	B = Blue G = Green GRA = Gray O = Orange P = Purple R = Red Y = Yellow WHT = White	0100 = 100 ft coil 0250 = 250 ft coil 0500 = 500 ft coil 1000 = 1000 ft coil	
PP = Polypropylene, White	3 = .188	3 = .188			
PPB = Polypropylene, Black	4 = .250 5 = .313	4 = .250 5 = .313			
PV = Vinyl	6 = .375 8 = .500 10 = .625	6 = .375 8 = .500 10 = .625			
	Metric Example	Metric Example			
	1 = 1mm 1.5 = 1.5mm	1 = 1mm 1.5 = 1.5mm			

*Note: PEFR & HDPE Tubing only available in black.
PV tubing only available in natural color.
Contact Parflex Division for additional size/color options.

Example: E-64-Y-0500

E-64-Y-0500 – Polyethylene
E-64-Y-0500 – Tube O.D. in sixteenths of an inch (**3/8"**)
E-64-Y-0500 – Tube I.D. in sixteenths of an inch (**1/4"**)
E-64-Y-0500 – Color, i.e. **Yellow** (Omit for Natural and Black)
E-64-0500 – Natural Polyethylene
EB-64-0500 – Black Polyethylene
E-64-Y-0500 – Package Quantity in feet (**500'**)

Example: PEFR-4-0500

PEFR-4-0500 – Flame Resistant Polyethylene
PEFR-4-0500 – Tube O.D. in sixteenths of an inch (**1/4"**)
PEFR-4-0500 – Package Quantity in feet (**500'**)

Example: PP-86-0250

PP-86-0250 – Polypropylene
PP-86-0250 - Natural
PPB-86-0250 -Black
PP-86-0250 – Tube O.D. in sixteenths of an inch (**1/2"**)
PP-86-0250 – Tube I.D. in sixteenths of an inch (**3/8"**)
PP-86-0250 – Package Quantity in feet (**250'**)

Example: EB-6X1-0100

EB-6X1-0100 – Polyethylene
EB-6X1-0100 – Tube O.D. in millimeters (**6**)
EB-6X1-0100 – Wall Thickness in millimeters (**1**) (Nominal I.D. 4mm)
EB-6X1-0100 – Package Quantity in feet (**100'**)

Example: PV108-1

PV108-1 – Poly-Vinyl
PV108-1 – Tube O.D. in sixteenths of an inch (**5/8"**)
PV108-1 – Tube I.D. in sixteenths of an inch (**1/2"**)
PV108-1 – Formula V-1 FDA Approved Formulation

Nomenclature Fluoropolymer Tubing

PTFE, FEP, PFA: Series 101/201, 103/203, 104/204, 105/205, 703/704



Product Family	Resin Family	Tube Size O.D.	Wall Thickness	Tubing Color	Tubing Packaging
1 = Fractional	01 = PTFE	See Selection Charts	See Selection Charts	N = Natural	T = Bulk
2 = Metric	03 = FEP			0 = Black	Default
7 = Retractable Coil	04 = PFA	Imperial Example 250 = .250 inch	Imperial Example 062 = .062 inch	1 = Brown	Configuration
9 = Custom	05 = PFA High Purity	Metric Example 700 = 7 mm	Metric Example 100 = 1 mm	2 = Red	
				3 = Orange	C = Tube Cut
				4 = Yellow	Job (followed by cut length in inches)
				5 = Green	
				6 = Blue	
				7 = Violet	
				8 = Gray	
				9 = White	

Tube Configuration	Tube Length
Blank = No color	25 = 25 ft coil
C = Solid Color	50 = 50 ft coil
S = Stripe on	100 = 100 ft coil
Tube	1000 = 1000 ft coil
L = Laser	
Marked	Blank = No cut xx.xxx = Length (inch)

Note: Parflex standard color is natural
Contact Parflex Division for additional size/color options.

Example: 101-0188062-0TC-100

101-0188062-0TC-100 – PTFE
 101-0188062-0TC-100 – Tube O.D. in inches (3/16")
 101-0188062-0TC-100 – Tube Wall Thickness in inches (.062")
 101-0188062-0TC-100 – Black
 101-0188062-0TC-100 – Bulk Tubing
 101-0188062-0TC-100 – Solid Color Tube
 101-0188062-0TC-100 – Package Quantity in feet (100')

Example: 704-0312062-xx0012

704-0312062-xx0012 – Retractable Tubing
 704-0312062-xx0012 – PFA
 704-0312062-xx0012 – Tube O.D. in inches (3/16")
 704-0312062-xx0012 – Tube Wall Thickness in inches (.062")
 704-0312062-xx0012 – Custom Options (when needed)
 704-0312062-xx0012 – Length in inches (12")

Nomenclature

Fluoropolymer Extra Flexible Tubing

PTFE, FEP, PFA: Series CV, CR, 81914



Product Family	Resin Family	Tube Size CV/CR	OR	*Tube Size Mil-Spec	Tubing Color	Tubing Packaging	Tube Length
CV = Convoluted	01 = PTFE	1/8		2 = 1/8"	N = Natural	T = Bulk	Blank = No cut
CR = Corrugated	03 = FEP	3/16		3 = 3/16"	0 = Black	Default	xx.xxx = Length (inch)
81914 = AMS-T Convo*	04 = PFA	1/4		4 = 1/4"	1 = Brown	Configuration	
	05 = PFA	5/16		5 = 5/16"	2 = Red		
	High Purity	3/8		6 = 3/8"	3 = Orange	C = Tube Cut	Cut length - has 4 decimal places for parts under 10 feet, and 5 for 10 feet and over
		1/2		8 = 1/2"	4 = Yellow	Job (followed by cut length in inches)	
		5/8		10 = 5/8"	5 = Green		
		3/4		12 = 3/4"	6 = Blue		
		1		16 = 1"	7 = Violet		
		1.25		20 = 1-1/2"	8 = Gray		ie. 1200 = 12"
		1.50		24 = 2-1/4"	9 = White		ie. 12000 = 120"
		2.00		32 = 2"			
		2.50		40 = 2-1/2"			
		3.00		48 = 3"			
		4.00		64 = 4"			

Note: Parflex standard color is natural for CV and CR. Contact Parflex Division for additional size/color options.

Example: CV01-1/8-NT

CV01-1/8-NT – Convoluted

CV01-1/8-NT – PTFE

CV01-1/8-NT – Tube O.D. in inches (1/8")

CV01-1/8-NT – Natural

CV01-1/8-NT – Bulk Tubing "T" is bulk (for cuffed tubing, remove "T" and add length, ie. **CV01-1/8-NT-N1200** = 1" Convo, natural, cut 12" long)

Example: 81914/1-1010-0TC

81914/1-1010-0TC – Mil Spec Convoluted

81914/1-1010-0TC – PTFE

81914/1-1010-0TC – Helical Convolutions

81914/1-1010-0TC – Size 10 = 1"

81914/1-1010-0TC – Color 0 = Black

81914/1-1010-0TC – Bulk Tubing "T" is bulk

Example: CR01-1.00-NC29.000-2C

CR03-1.00-NC29.000-2C – Corrugated Tubing

CR03-1.00-NC29.000-2C – FEP

CR03-1.00-NC29.000-2C – Tube Size (Nominal I.D. 1")

CR03-1.00-NC29.000-2C – Natural

CR03-1.00-NC29.000-2C – Cut Piece

CR03-1.00-NC29.000-2C – Overall Length in inches (29")

CR03-1.00-NC29.000-2C – Standard Cuff on each end

Nomenclature Fluoropolymer Heat Shrink

PTFE and FEP: Series HS2, HS4, HS1.3, HS1.6, HS1.25

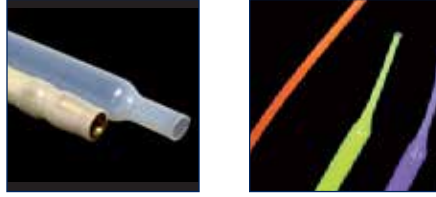

Product Family**	Resin Family	Special Configuration	Tube Sizes**	Tube Color
HS2 = 2:1 Ratio PTFE	TF = PTFE	H = Heavy Wall	XX for	N = Natural
HS4 = 4:1 Ratio PTFE	FP = FEP	S = Standard Wall	AWG sizes	0 = Black
HS1.3 = 1.3/1:1 Ratio FEP	PF = PFA	T = Thin Wall	0-30	1 = Brown
HS1.6 = 1.67:1 Ratio FEP	ET = ETFE	L = Light Wall		2 = Red
HS1.25 = 1.25:1 Ratio FEP		I = Industrial Wall	X/X for Fractional sizes 1/8 to 1.00 inch	3 = Orange
				4 = Yellow
				5 = Green
				6 = Blue
				7 = Violet
				8 = Gray
				9 = White

Packaging ***	Tube Configuration	Other Options
T = Bulk Default Configuration	Blank = No color C = Solid Color S = Stripe on Tube	Blank = Not required
C = Tube Cut Job (followed by cut length in inches)		xx.xxx = Add cut length in inches

Note: Parflex standard color is natural.
Contact Parflex Division for additional size/color options.

Example: HS2TFS15-4TC48.000

HS2TFS15-4TC48.000 – Heat Shrink
 HS2TFS15-4TC48.000 – Shrink Ratio (2:1)
 HS2TFS15-4TC48.000 – PTFE
 HS2TFS15-4TC48.000 – Wall Type (Standard Wall)
 HS2TFS15-4TC48.000 – Heat Shrink Size in AWG (AWG15)
 HS2TFS15-4TC48.000 – Red
 HS2TFS15-4TC48.000 – Bulk Tubing
 HS2TFS15-4TC48.000 – Solid Color
 HS2TFS15-4TC48.000 – Package Quantity in inches (48')

Example: HS4TFI5/8-NC48.000

HS4TFI5/8-NC48.000 – Heat Shrink
 HS4TFI5/8-NC48.000 – Shrink Ratio (4:1)
 HS4TFI5/8-NC48.000 – PTFE
 HS4TFI5/8-NC48.000 – Wall Type (Industrial Wall)
 HS4TFI5/8-NC48.000 – Heat Shrink Size in inches (5/8")
 HS4TFI5/8-NC48.000 – Natural
 HS4TFI5/8-NC48.000 – Bulk Tubing
 HS4TFI5/8-NC48.000 – Package Quantity in inches (48')

Example: HS1.3FEP24-NT

HS1.3FEP24-NT – Heat Shrink Tubing
 HS1.3FEP24-NT – Shrink Ratio (1:3)
 HS1.3FEP24-NT – FEP
 HS1.3FEP24-NT – Heat Shrink Size in AWG (AWG24)
 HS1.3FEP24-NT – Natural
 HS1.3FEP24-NT – Bulk Tubing - Coil

Example: HS1.6FEP3/32-NC48.000

HS1.6FEP3/32-NC48.000 – Heat Shrink Tubing
 HS1.6FEP3/32-NC48.000 – Shrink Ratio (1.67:1)
 HS1.6FEP3/32-NC48.000 – FEP
 HS1.6FEP3/32-NC48.000 – Heat Shrink Size in inches (3/32")
 HS1.6FEP3/32-NC48.000 – Natural
 HS1.6FEP3/32-NC48.000 – Cut Tubing
 HS1.6FEP3/32-NC48.000 – Cut length in inches (48")

Nomenclature

Fluoropolymer Spiral Cut Tubing and Beading

PTFE: Series TSWTF, TFB

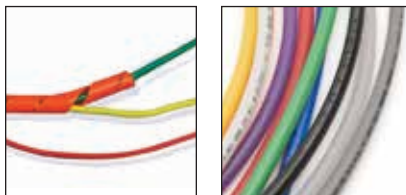

Product Family	Resin Family	Tube O.D.	
TSWTF	TF = PTFE	1/8	1
		3/16	1.25
		1/4	1.50
		5/16	2.00
		3/8	2.50
		1/2	3.00
		5/8	4.00
		3/4	

Product Family	Resin Family	Tube O.D.		
TFB*	TF = PTFE	0.015	0.050	0.090
		0.020	0.055	0.094
		0.025	0.060	0.100
		0.028	0.062	0.109
		0.031	0.070	0.115
		0.035	0.072	0.125
		0.039	0.078	0.150
		0.043	0.080	0.188
		0.047	0.084	

Tubing Color		Tubing Packaging		Configuration
N = Natural	5 = Green	T = Bulk	C = Tube Cut	Spiral Wrap
0 = Black	6 = Blue	Default	Job (followed	R = Right hand cut
1 = Brown	7 = Violet	Configuration	by cut length	L = Left hand cut
2 = Red	8 = Gray		in inches)	
3 = Orange	9 = White			Color
4 = Yellow				C = Solid Color

Note: Parflex standard color is natural.
Contact Parflex Division for additional size/color options.

Example: TSWTF-3/8-5TC-R

TSWTF-3/8-5TC-R – Spiral Wrap Tubing
TSWTF-3/8-5TC-R – PTFE
TSWTF-3/8-5TC-R – Tube O.D. in inches (3/8")
TSWTF-3/8-5TC-R – Green
TSWTF-3/8-5TC-R – Bulk Tubing
TSWTF-3/8-5TC-R – Solid Color
TSWTF-3/8-5TC-R – Right Hand Cut Spiral

Example: TFB028-NT

TFB028-NT – PTFE Beading
TFB028-NT – Beading O.D. in inches (0.028")
TFB028-NT – Natural
TFB028-NT – Bulk Tubing

Polyethylene Tubing

Series E: Instrument Grade

Series EB: Ultraviolet (UV) resistant

NSF-51, NSF-61 and FDA compliant
for Food and Beverage contact.



Features

- Produced with 100% virgin resin
- Chemically resistant and flexible
- Economic system solution
- Excellent stress crack resistance

Compliance

- FDA, CFR21 Part 177 Compliant for Food Contact
- ASTM D-1693
- NSF – 51
- NSF – 61

Notes

- All tubing conforms to ASTM D-1248, Type 1, Class A, Category 4, Grade E5
- Series E natural and colored tubing meets FDA, NSF-51 requirements for food contact and NSF-61 for potable water
- Series E black (Series EB) tubing suggested for use in sunlit areas and in proximity to high UV light sources
- For FDA and/or NSF compliant black (Series EB) tubing, add -NSF to the EB part number
- Resistant to environmental stress cracking as measured by ASTM D-1693 (10% IGEPAL)
- Suggested operating temperature range is -80°F (-62°C) to 150°F (66°C) - reference Pressure vs. Temperature charts as pressures are lower at elevated temperatures
- Working pressure and burst pressure are at 73°F (23°C)

Fittings

Parker Fittings available from:
Fluid System Connectors Division
Otsego, MI

(269) 692-6555
(269) 692-6634 FAX
parker.com/fsc

For approved fittings and/or suggested use of tube supports,
reference Tube/Fitting Compatibility Chart (pg. B-8/B-9) or
contact Parker Fluid Systems Connectors Division

Order Information

Example: E-64-Y-0500

E-64-Y-0500 – Polyethylene

E-64-Y-0500 – Tube O.D. in sixteenths of an inch (**3/8"**)

E-64-Y-0500 – Tube I.D. in sixteenths of an inch (**1/4"**)

E-64-Y-0500 – Color, i.e. **Yellow** (Omit for Natural and Black)

E-64-0500 – Natural Polyethylene

EB-64-0500 – Black Polyethylene

E-64-Y-0500 – Package Quantity in feet (**500'**)

Example: EB-6X1-0100

EB-6X1-0100 – Polyethylene

EB-6X1-0100 – Tube O.D. in millimeters (**6**)

EB-6X1-0100 – Wall Thickness in millimeters (**1**) (Nominal I.D. 4mm)

EB-6X1-0100 – Package Quantity in feet (**100'**)



WARNING

This product can expose you to chemicals including Titanium dioxide, which is known to the State of California to cause cancer. For more information go to www.P65Warnings.ca.gov.

Polyethylene Tubing

Series E: Instrument Grade

Series EB: Ultraviolet (UV) resistant

Series E/EB - PE Metric Size Tubing - Natural and Colors

Part Number	Nominal O.D.		Nominal I.D.		Average Wall Thickness		Working Pressure 73°F (23°C)		Minimum Burst Pressure		Minimum Bend Radius		Weight		Color
	mm	inch	mm	inch	mm	inch	bar	psi	bar	psi	mm	inch	kg/mtr	lbs./ft.	
E-6X1-0100 EB-6X1-0100	6	.236	4.0	.157	1.00	.039	8.6	125	34.5	500	25.0	1	.019	.013	○ ●
E-8X1-0100 EB-8X1-0100	8	.315	6.0	.236	1.00	.039	6.9	100	27.6	400	38.0	1-1/2	.021	.014	○ ●
E-10X1.5-0100 EB-10X1.5-0100	10	.394	7.0	.276	1.50	.059	8.6	125	34.5	500	38.0	1-1/2	.039	.026	○ ●
E-12X1.5-0100 EB-12X1.5-0100	12	.472	9.0	.354	1.50	.059	6.2	90	24.8	360	63.0	2-1/2	.048	.032	○ ●

Colors

- Metric sizes

Color Code		
○	-	Natural
●	EB	Black

Polyethylene Metric Tubing (Series E/EB) Maximum Working Pressure (bar)

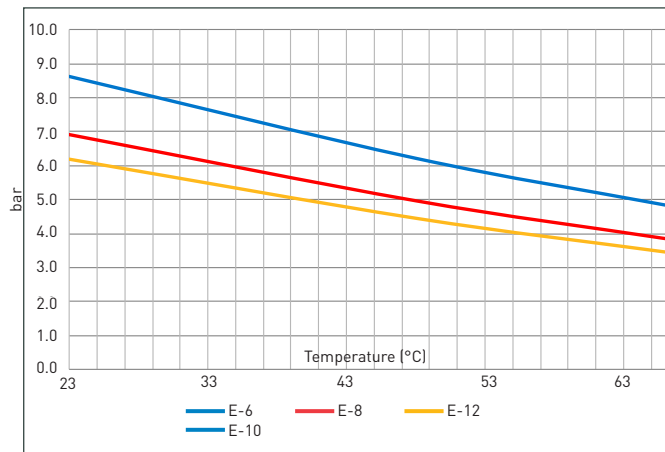

WARNING

This product can expose you to chemicals including Titanium dioxide, which is known to the State of California to cause cancer. For more information go to www.P65Warnings.ca.gov.

Polyethylene Tubing

Series PEFR: Flame Resistant

Flame Resistant



Features

- Flame resistant
- High strength & excellent flexibility
- Resistant to environmental stress cracking

Compliance

- UL 94 V-2
- ASTM D-1693

Notes

- Produced from LLDPE (linear low density polyethylene) resin
- Resistant to environmental stress cracking as measured by ASTM D-1693 (10% IGEPAL)
- Suggested operating temperature range is -85°F (-6°C) to 150°F (66°C) - reference Pressure vs. Temperature charts as pressures are lower at elevated temperatures
- Working pressure and burst pressure are at 73°F (23°C)

Fittings

Parker Fittings available from:
Fluid System Connectors Division
Otsego, MI

(269) 692-6555
(269) 692-6634 FAX
parker.com/fsc

For approved fittings and/or suggested use of tube supports, reference Tube/Fitting Compatibility Chart (pg. B-8/B-9) or contact Parker Fluid Systems Connectors Division

Order Information

Example: PEFR-4-0500

PEFR-4-0500 – Flame Resistant Polyethylene

PEFR-4-0500 – Tube O.D. in sixteenths of an inch (1/4")

PEFR-4-0500 – Package Quantity in feet (500')



WARNING

This product can expose you to chemicals including Antimony Oxide (Antimony Trioxide), which is known to the State of California to cause cancer. For more information go to www.P65Warnings.ca.gov.

Polyethylene Tubing

Series PEFR: Flame Resistant

Series PEFR - Flame Resistant Polyethylene Size Tubing

Part Number	Nominal O.D.		Nominal I.D.		Average Wall Thickness		Working Pressure 73°F (23°C)		Minimum Burst Pressure		Minimum Bend Radius		Weight		Color
	inch	mm	inch	mm	inch	mm	psi	bar	psi	bar	inch	mm	lbs./ft.	kg/mtr	
PEFR-2.5-0500	5/32	4.0	.096	2.4	.030	0.8	185	12.8	740	51.0	1/2	12.5	.006	.009	
PEFR-4-0500 PEFR-4-1000	1/4	6.4	.170	4.3	.040	1.0	140	9.7	560	38.6	3/4	19.0	.012	.018	●
PEFR-6-0500	3/8	9.5	.250	6.4	.062	1.6	155	10.7	620	42.8	1-1/2	38.0	.029	.043	●
PEFR-8-0250	1/2	12.7	.375	9.5	.062	1.6	100	6.9	400	27.6	1-3/4	44.5	.041	.061	●

Note: If color not referenced, contact the division for availability.

Flame Resistant Polyethylene Tubing (Series PEFR) Maximum Working Pressure (psig)

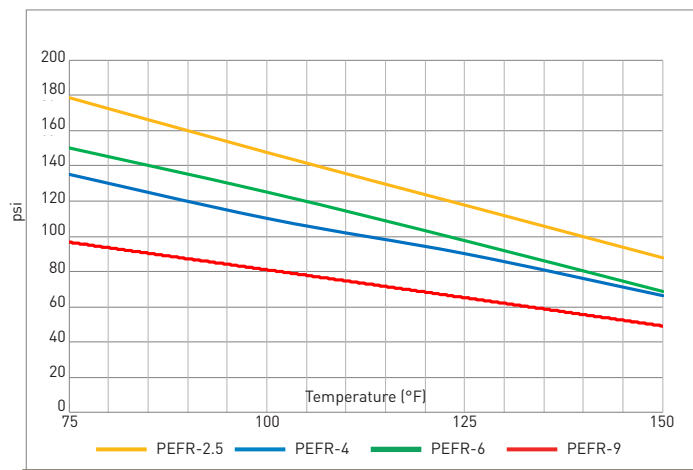

Colors

Color Code		
●	-	Black

WARNING
 This product can expose you to chemicals including Antimony Oxide (Antimony Trioxide), which is known to the State of California to cause cancer. For more information go to www.P65Warnings.ca.gov.

Polyethylene Tubing

Series HDPE: High Strength

Excellent economical alternative to Nylon tubing.



Features

- Manufactured from high strength, high density polyethylene
- Excellent economical alternative to Nylon in various industrial applications due to strength and durability
- Economical system solution

Notes

- Suggested operating temperature range is -80°F (-62°C) to 175°F (80°C) - reference Pressure vs. Temperature charts as pressures are lower at elevated temperatures
- Working pressure and burst pressure are at 73°F (23°C)

Fittings

Parker Fittings available from:
Fluid System Connectors Division
Otsego, MI

(269) 692-6555
(269) 692-6634 FAX
parker.com/fsc

For approved fittings and/or suggested use of tube supports, reference Tube/Fitting Compatibility Chart (pg. B-8/B-9) or contact Parker Fluid Systems Connectors Division

Order Information

Example: HDPE-43-0500

HDPE-43-0500 – High Density Polyethylene

HDPE-43-0500 – Tube O.D. in sixteenths of an inch (1/4")

HDPE-43-0500 – Tube I.D. in sixteenths of an inch (.170")

HDPE-43-0500 – Package Quantity in feet (500')



WARNING

This product can expose you to chemicals including Titanium dioxide, which is known to the State of California to cause cancer. For more information go to www.P65Warnings.ca.gov.

Polyethylene Tubing

Series HDPE: High Strength

Series HDPE - High Strength Polyethylene Size Tubing

Part Number	Nominal O.D.		Nominal I.D.		Average Wall Thickness		Working Pressure 73°F (23°C)		Minimum Burst Pressure		Minimum Bend Radius		Weight		Color
	inch	mm	inch	mm	inch	mm	psi	bar	psi	bar	inch	mm	lbs./ft.	kg/mtr	
HDPE-43-0250 HDPE-43-0500	1/4	6.4	.170	4.3	.040	1.0	300	20.7	1200	82.7	1-1/2	38.0	.011	.016	●
HDPE-64-0250 HDPE-64-0500	3/8	9.5	.250	6.4	.062	1.6	300	20.7	1200	82.7	2-1/2	63.5	.025	.037	●

High Density Polyethylene Tubing (Series HDPE) Maximum Working Pressure (psig)

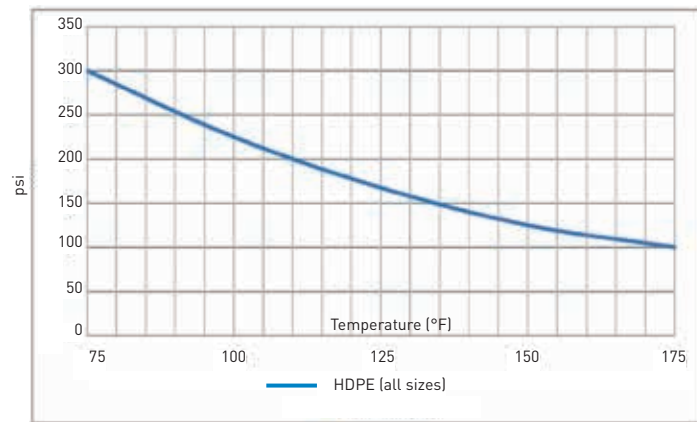

Colors

Color Code		
●	-	Black

WARNING This product can expose you to chemicals including Titanium dioxide, which is known to the State of California to cause cancer. For more information go to www.P65Warnings.ca.gov.

Nylon Tubing

Series N/NB Fractional and Metric

Abrasion resistant, heat and light stabilized resin.



Features

- Produced from abrasion resistant, heat and light stabilized nylon resin
- High-grade resins for strength and flexibility
- Low moisture absorption
- Chemically resistant
- EZ pack (100') boxes available

Notes

- Black (Series NB) tubing suggested for use in sunlit areas and in proximity to high UV light sources
- Suggested operating temperature range is -65°F (-54°C) to 200°F (93°C) - reference Pressure vs. Temperature charts as pressures are lower at elevated temperatures
- Working pressure and burst pressure are at 73°F (23°C)

Fittings

Parker Fittings available from:
Fluid System Connectors Division
Otsego, MI

(269) 692-6555
(269) 692-6634 FAX
parker.com/fsc

For approved fittings and/or suggested use of tube supports, reference Tube/Fitting Compatibility Chart (pg. B-8/B-9) or contact Parker Fluid Systems Connectors Division

Example: N-4-035-Red

N-4-035-Red- Nylon
N-4-035-Red- Tube O.D. in sixteenths of an inch (**1/4"**)
N-4-035-Red- Wall Thickness in inches (**.035"**)
N-4-035-Red- Color, i.e. **Red** (Omit for Natural and Black)
NN-4-035-EZ - 100 ft box, Natural Nylon
NB-4-035-0100 - Black Nylon
N-4-035-Red- Package Quantity in feet (**250'**)

Standard 250' package has no length reference.
Add -EZ for 100' boxed coil (NB-4-035-EZ)

Order Information

Example: NN4x.65

NN4x.65 - Nylon
NN4x.65 - Tube O.D. in millimeters (**4**)
NN4x.65 - Wall Thickness in millimeters (**.65**)

(Standard 100' package has no length reference)



WARNING

This product can expose you to chemicals including Nickel compounds, which is known to the State of California to cause cancer. For more information go to www.P65Warnings.ca.gov.

Nylon Tubing

Series N/NB Fractional

Series N - Nylon Fractional Size Tubing

Part Number	Nominal O.D.		Nominal I.D.		Average Wall Thickness		Working Pressure 73°F (23°C)		Minimum Burst Pressure		Minimum Bend Radius		Weight		Color
	inch	mm	inch	mm	inch	mm	psi	bar	psi	bar	inch	mm	lbs./ft.	kg/mtr	
NN-2-016 NB-2-016 N-2-016-XXX	1/8	3.2	.093	2.4	.016	0.4	250	17.2	1000	69.0	1/2	12.5	.003	.004	●
NN-2-031 NB-2-031 N-2-031-XXX	1/8	3.2	.064	1.6	.031	0.8	500	34.5	2000	137.9	1/4	6.5	.004	.006	●
NN-2.5-025 NB-2.5-025 N-2.5-025-XXX	5/32	4.0	.106	2.7	.025	0.6	300	20.7	1200	82.7	1/2	12.5	.005	.007	● ● ● ● ●
NN-3-025 NB-3-025 N-3-025-XXX	3/16	4.8	.138	3.5	.025	0.6	250	17.2	1000	69.0	5/8	16.0	.006	.009	●
NN-3-046 NB-3-046 N-3-046-XXX	3/16	4.8	.096	2.4	.046	1.2	500	34.5	2000	137.9	7/16	11.0	.009	.013	●
NN-4-035 NN-4-035-EZ NB-4-035 NB-4-035-EZ N-4-035-XXX	1/4	6.4	.180	4.6	.035	0.9	250	17.2	1000	69.0	7/8	22.0	.011	.016	● ● ● ● ●
NN-4-040 NN-4-040-EZ NB-4-040 NB-4-040-EZ N-4-040-XXX	1/4	6.4	.170	4.3	.040	1.0	310	21.4	1250	86.2	7/8	22.0	.012	.018	● ● ● ● ●
NN-4-062 NB-4-062 N-4-062-XXX	1/4	6.4	.125	3.2	.062	1.6	500	34.5	2000	137.9	1/2	12	.017	.025	●
NN-5-040 NB-5-040 N-5-040-XXX	5/16	7.9	.233	5.9	.040	1.0	250	17.2	1000	69.0	1-1/8	28.5	.016	.024	●

Note: If color not referenced, contact the division for availability.
 Standard 250' package has no length reference.
 -EZ : 100' EZ pack box



WARNING

This product can expose you to chemicals including Nickel compounds, which is known to the State of California to cause cancer. For more information go to www.P65Warnings.ca.gov.

Nylon Tubing

Series N/NB Fractional

Series N - Nylon Fractional Size Tubing

Part Number	Nominal O.D.		Nominal I.D.		Average Wall Thickness		Working Pressure 73°F (23°C)		Minimum Burst Pressure		Minimum Bend Radius		Weight		Color
	inch	mm	inch	mm	inch	mm	psi	bar	psi	bar	inch	mm	lbs./ft.	kg/mtr	
NN-6-050 NN-6-050-EZ NB-6-050 NB-6-050-EZ N-6-050-XXX	3/8	9.5	.275	7.0	.050	1.3	250	17.2	1000	69.0	1-1/8	28.5	.023	.034	○
○															
●															
●															
● ● ● ● ●															
NN-6-093 NB-6-093 N-6-093-XXX	3/8	9.5	.190	4.8	.093	2.4	500	34.5	2000	137.9	3/4	19.0	.038	.057	○
○															
●															
NN-8-062 NN-8-062-EZ NB-8-062 NB-8-062-EZ NN-8-062-XXX	1/2	12.7	.375	9.5	.062	1.6	250	17.2	1000	69.0	1-1/4	32.0	.039	.058	○
○															
○															
●															
●															
NN-8-124 NB-8-124 N-8-124-XXX	1/2	12.7	.253	6.4	.124	3.2	500	34.5	2000	137.9	1	25.5	.067	.100	○
○															
●															

Note: If color not referenced, contact the division for availability.
 Standard 250' package has no length reference.
 -EZ : 100' EZ pack box

Colors

Color Code		
○	NN	Natural
●	NB	Black
●	BLU	Blue
●	GRN	Green
●	RED	Red
●	YEL	Yellow

Nylon Tubing (Series N/NB) Maximum Working Pressure (psi)

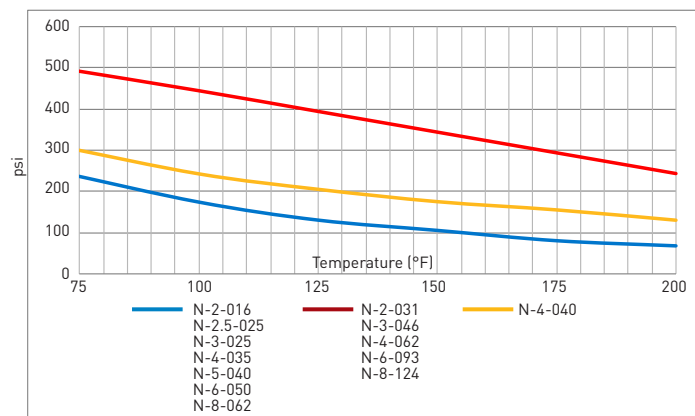

WARNING

This product can expose you to chemicals including Nickel compounds, which is known to the State of California to cause cancer. For more information go to www.P65Warnings.ca.gov.

Nylon Tubing

Series N/NB Metric

Series N/NB - Nylon Metric Size Tubing - Natural and Black

Part Number	Nominal O.D.		Nominal I.D.		Average Wall Thickness		Working Pressure 73°F (23°C)		Minimum Burst Pressure		Minimum Bend Radius		Weight		Color
	mm	inch	mm	inch	mm	inch	bar	psi	bar	psi	mm	inch	kg/mtr	lbs./ft.	
NN4x.65 NB4x.65	4	.157	2.7	.106	0.65	.026	26.0	377	104	1508	14.0	9/16	.007	.005	○
NN6X1 NB6X1	6	.236	4.0	.157	1.00	.039	23.5	340	94	1363	22.0	7/8	.016	.011	●
NN8X1 NB8X1	8	.315	6.0	.236	1.00	.039	17.0	246	68	986	29.0	1-1/8	.024	.016	○
NN10X1 NB10X1	10	.394	8.0	.315	1.00	.039	12.5	181	50	725	34.0	1-5/16	.030	.020	●
NN12X1 NB12X1	12	.472	10.0	.394	1.00	.039	11.0	159	44	638	45.0	1-3/4	.036	.024	○
NN14X1.5 NB14X1.5	14	.551	11.0	.433	1.50	.059	15.0	217	60	870	57.0	2-1/4	.063	.042	○
NN16X1.5 NB16X1.5	16	.630	13.0	.512	1.50	.059	12.5	181	50	725	74.0	2-7/8	.073	.049	○
NN18X1.5 NB18X1.5	18	.709	15.0	.591	1.50	.059	10.5	152	42	609	92.0	3-5/8	.082	.055	○
NN20X1.5 NB20X1.5	20	.787	17.0	.669	1.50	.059	9.5	137	38	551	112.0	4-3/8	.092	.062	○

Note: If color not referenced, contact the division for availability.
Standard 100' package has no length reference.

Colors

- Metric sizes

Color Code		
○	NN	Natural
●	NB	Black

Nylon Metric Tubing (Series N/NB) Maximum Working Pressure (bar)

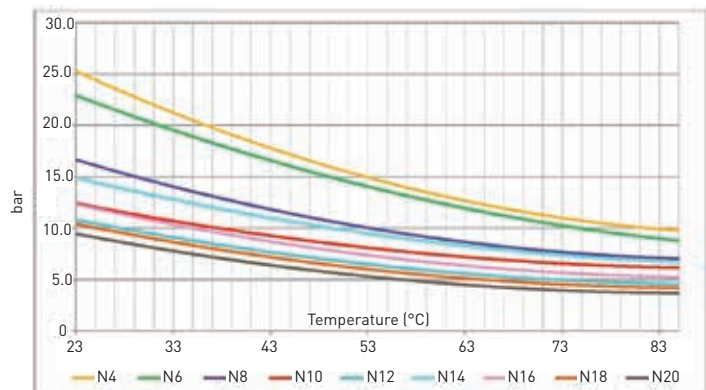

WARNING

This product can expose you to chemicals including Nickel compounds, which is known to the State of California to cause cancer. For more information go to www.P65Warnings.ca.gov.

Nylon Tubing

Series PAT: Pure Air Tubing

Excellent chemical and UV light resistance.



Features

- Specially formulated nylon for pure air systems and gas distribution systems (semiconductor) due to its cleanliness and excellent chemical and UV light resistance
- Low moisture absorption
- High tensile strength

Notes

- Packaged on a corrugated plastic reel with ends capped and shipped in plastic-lined container
- PAT2 and PAT4 are single-wall extruded Nylon and PAT6 to PAT12 are reinforced constructions
- Suggested operating temperature range is -70°F (-57°C) to 200°F (93°C). Reference Pressure vs. Temperature charts as pressures are lower at elevated temperatures
- Working pressure and burst pressure are at 73°F (23°C)

Fittings

Parker Fittings available from:
Fluid System Connectors Division
Otsego, MI

(269) 692-6555
(269) 692-6634 FAX
parker.com/fsc

For approved fittings and/or suggested use of tube supports, reference Tube/Fitting Compatibility Chart (pg. B-8/B-9) or contact Parker Fluid Systems Connectors Division

Order Information

Example: PAT4-BLK-1000

PAT4-BLK-1000 – Nylon

PAT**4**-BLK-1000 – **Tube O.D.** in sixteenths of an inch (**1/8"**)

PAT4-**BLK**-1000 – **Black** (Omit for Natural)

PAT4-BLK-**1000** – **Package Quantity** in feet (**1000'**)



WARNING

This product can expose you to chemicals including Nickel compounds, which is known to the State of California to cause cancer. For more information go to www.P65Warnings.ca.gov.

Nylon Tubing

Series PAT: Pure Air Tubing

Series PAT - Pure Air Nylon Tubing

Part Number	Nominal O.D.		Nominal I.D.		Average Wall Thickness		Working Pressure 73°F (23°C)		Minimum Burst Pressure		Minimum Bend Radius		Weight	
	inch	mm	inch	mm	inch	mm	psi	bar	psi	bar	inch	mm	lbs./ft.	kg/mtr
PAT2-XXX-1000	1/8	3.2	.079	2.0	.023	0.6	250	17.2	1000	69.0	3/8	9.5	.003	.004
PAT4-XXX-1000	1/4	6.4	.170	4.3	.040	1.0	300	20.7	1200	82.7	1	25.5	.012	.018
PAT6-XXX-500	3/8	9.5	.251	6.4	.062	1.6	350	24.1	1400	96.4	1-1/2	38.0	.027	.040
PAT8-XXX-500	1/2	12.7	.376	9.6	.062	1.6	235	16.2	950	65.5	2	51.0	.038	.057
PAT12-XXX-250	3/4	19.1	.566	14.4	.092	2.3	200	13.8	800	55.2	3	76.0	.088	.131

Note: If color not referenced, contact the division for availability.

Nylon Tubing (Series PAT) Maximum Working Pressure (psi)

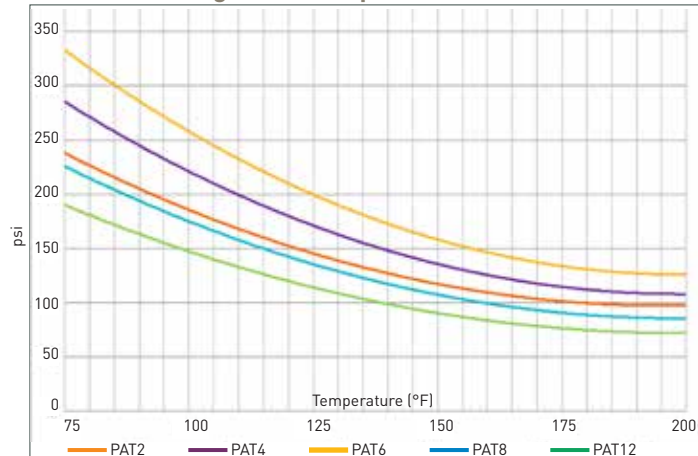

Colors

Color Code		
●	BLK	Black
●	SIL	Silver
●	BRN	Brown



WARNING

This product can expose you to chemicals including Nickel compounds, which is known to the State of California to cause cancer. For more information go to www.P65Warnings.ca.gov.

Nylon Tubing

Series NR/NBR: Semi-Rigid High Strength

High tensile strength yielding
excellent coupling retention.



Features

- High grade nylon resins without plasticizers for higher pressure tubing applications
- High tensile strength and excellent coupling retention
- Produced from abrasion resistant, heat and light stabilized nylon resin
- Low moisture absorption
- Chemically resistant

Notes

- Black (Series NBR) tubing suggested for use in sunlit areas and in proximity to high UV light sources
- Suggested operating temperature range is -60°F (-51°C) to 200°F (93°C) - reference Pressure vs. Temperature charts as pressures are lower at elevated temperatures
- Working pressure and burst pressure are at 73°F (23°C)

Fittings

Parker Fittings available from:
Fluid System Connectors Division
Otsego, MI

(269) 692-6555
(269) 692-6634 FAX
parker.com/fsc

For approved fittings and/or suggested use of tube supports,
reference Tube/Fitting Compatibility Chart (pg. B-8/B-9) or
contact Parker Fluid Systems Connectors Division

Order Information

Example: NBR-2-017

NBR-2-017– Nylon

NBR-2-017– Black

NBR-2-017– Rigid

NBR-2-017– Tube O.D. in sixteenths
of an Inch (**1/8"**)

NBR-2-017– Wall Thickness in inches (**.017"**)

NBR-2-017– Package Quantity in feet (**250'**)

Standard 250' package has no length reference.



WARNING

This product can expose you to chemicals including Nickel compounds, which is known to the State of California to cause cancer. For more information go to www.P65Warnings.ca.gov.

Nylon Tubing

Series NR/NBR: Semi-Rigid High Strength

Series NR/NBR - Semi-Rigid High Strength Nylon Tubing - Natural and Black

Part Number	Nominal O.D.		Nominal I.D.		Average Wall Thickness		Working Pressure 73°F (23°C)		Minimum Burst Pressure		Minimum Bend Radius		Weight		Color
	inch	mm	inch	mm	inch	mm	psi	bar	psi	bar	mm	inch	lbs./ft.	kg/mtr	
NNR-2-017 NBR-2-017	1/8	3.2	.091	2.3	.017	0.4	425	29.3	1700	117.2	1/2	12.5	.003	.004	○
NNR-2-026 NBR-2-026	1/8	3.2	.073	1.9	.026	0.7	625	43.1	2500	172.4	3/8	9.5	.004	.006	●
NNR-3-024 NBR-3-024	3/16	4.8	.140	3.6	.024	0.6	425	29.3	1700	117.2	3/4	19.0	.006	.009	○
NNR-3-039 NBR-3-039	3/16	4.8	.110	2.8	.039	1.0	625	43.1	2500	172.4	5/8	16.0	.008	.012	●
NNR-4-035 NBR-4-035	1/4	6.4	.180	4.6	.035	0.9	425	29.3	1700	117.2	1	25.5	.011	.016	●
NNR-4-050 NBR-4-050	1/4	6.4	.150	3.8	.050	1.3	625	43.1	2500	172.4	7/8	22.0	.014	.021	●
NNR-5-040 NBR-5-040	3/8	7.9	.233	5.9	.040	1.0	425	29.3	1700	117.2	1-1/2	38.0	.015	.022	●
NNR-6-048 NBR-6-048	3/8	9.5	.279	7.1	.048	1.2	425	29.3	1700	117.2	1-3/4	44.5	.022	.033	●
NNR-6-075 NBR-6-075	3/8	9.5	.225	5.7	.075	1.9	625	43.1	2500	172.4	1-1/2	38.0	.032	.048	●
NNR-8-062 NBR-8-062	1/2	12.7	.375	9.5	.062	1.6	375	25.9	1500	103.4	2-3/8	60.5	.038	.057	●
NNR-8-075 NBR-8-075	1/2	12.7	.350	8.9	.075	1.9	625	43.1	2500	172.4	2-1/2	63.5	.045	.067	●

Note: If color not referenced, contact the division for availability.
 Standard pack part number has no length reference.
 Package quantity: -2 to -3 is 500'
 -4 to -8 is 250'

Colors

Color Code		
○	NNR	Natural
●	NBR	Black

Nylon Tubing (Series NR) Maximum Working Pressure (psi)

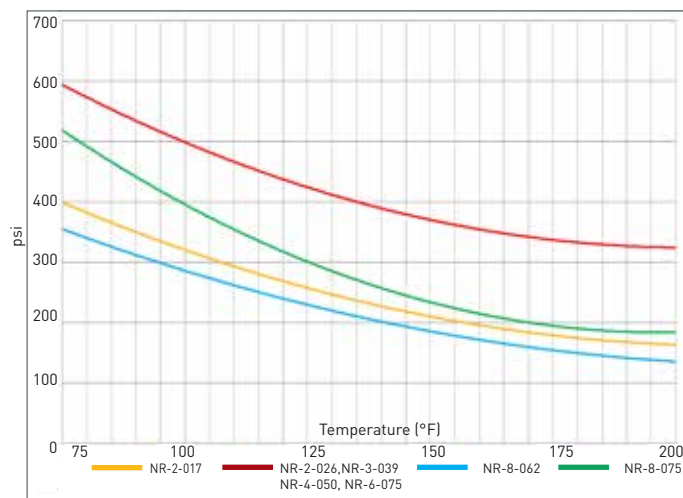

WARNING

This product can expose you to chemicals including Nickel compounds, which is known to the State of California to cause cancer. For more information go to www.P65Warnings.ca.gov.

Polypropylene Tubing

Series PP: Laboratory Grade – FDA, NSF Listed
Series PPB: Ultraviolet Light Resistant

Less than .01% water absorption.



Features

- Excellent resistance to hot water, acids, chemicals and vegetable oils
- Low water absorption (less than .01%)
- Excellent resistance to stress cracking

Compliance

- White tubing (PP-series) FDA, CFR21 Part 177 compliant for Food Contact
- NSF-51 compliant

Notes

- Black (Series PPB) tubing suggested for use in sunlit areas and in proximity to high UV light sources
- Suggested operating temperature range is 0°F (-18°C) to 200°F (93°C) - reference Pressure vs. Temperature charts as pressures are lower at elevated temperatures
- Working pressure and burst pressure are at 73°F (23°C)

Fittings

Parker Fittings available from:
Fluid System Connectors Division
Otsego, MI

(269) 692-6555
(269) 692-6634 FAX
parker.com/fsc

For approved fittings and/or suggested use of tube supports, reference Tube/Fitting Compatibility Chart (pg. B-8/B-9) or contact Parker Fluid Systems Connectors Division

Order Information

Example: PP-86-0250

PP-86-0250 – Polypropylene

PP-86-0250 - White

PPB-86-0250 - Black

PP-86-0250 – **Tube O.D.** in sixteenths of an inch (**1/2"**)

PP-86-0250 – **Tube I.D.** in sixteenths of an inch (**3/8"**)

PP-86-**0250** – **Package Quantity** in feet (**250'**)



WARNING

This product can expose you to chemicals including Titanium dioxide, which is known to the State of California to cause cancer. For more information go to www.P65Warnings.ca.gov.

Polypropylene Tubing

Series PP: Laboratory Grade – FDA, NSF Listed
 Series PPB: Ultraviolet Light Resistant

Series PP: Laboratory Grade – FDA, NSF Listed - White
Series PPB: Ultraviolet Light Resistant - Black

Part Number	Nominal O.D.		Nominal I.D.		Average Wall Thickness		Working Pressure 73°F (23°C)		Minimum Burst Pressure		Minimum Bend Radius		Weight		Color
	inch	mm	inch	mm	inch	mm	psi	bar	psi	bar	inch	mm	lbs./ft.	kg/mtr	
PP-21-1000 PPB-21-1000	1/8	3.2	.079	2.0	.023	0.6	350	24.1	1400	96.5	1/2	12.5	.003	.004	
PP-32-0500 PPB-32-0500	3/16	4.8	.120	3.0	.034	0.9	350	24.1	1400	96.5	3/4	19.0	.006	.009	
PP-43-0500 PPB-43-0500	1/4	6.4	.170	4.3	.040	1.0	300	20.7	1200	82.7	1	25.5	.010	.015	○ ●
PP-53-0500 PPB-53-0500	5/16	7.9	.188	4.8	.062	1.6	350	24.1	1400	96.5	1-1/4	32.0	.019	.028	
PP-64-0500 PPB-64-0500	3/8	9.5	.250	6.4	.062	1.6	300	20.7	1200	82.7	1-1/4	32.0	.024	.036	○ ●
PP-86-0250 PPB-86-0250	1/2	12.7	.375	9.5	.062	1.6	225	15.5	900	62.1	2-1/2	63.5	.033	.049	○ ●
PP-108-0100 PPB-108-0100	5/8	15.9	.500	12.7	.062	1.6	175	12.1	700	48.3	4	101.5	.042	.063	○

Note: If color not referenced, contact the division for availability.

Colors

Color Code		
○	PP	White
●	PPB	Black

Polypropylene Tubing (Series PP & PPB) Maximum Working Pressure (psi)

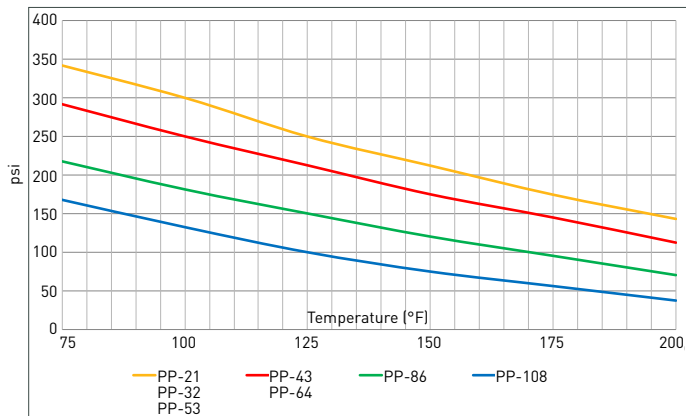

WARNING

This product can expose you to chemicals including Titanium dioxide, which is known to the State of California to cause cancer. For more information go to www.P65Warnings.ca.gov.

Polyurethane Tubing

Series 95U/95UM: Polyether Base

Excellent abrasion
and kink resistance.



Features

- 95 Shore A durometer
- Excellent abrasion and kink resistance
- Excellent moisture resistance
- Easy to assemble with approved fittings
- Constructed from UV resistant Polyurethane
- Exhibits the elongation and recovery characteristics of rubber and the chemical resistance of a thermoplastic
- EZ Pack 100' boxes available

Notes

- Suggested operating temperature range is -40°F (-18°C) to 180°F (82°C) - reference Pressure vs. Temperature charts as pressures are lower at elevated temperatures
- Working pressure and burst pressure are at 73°F (23°C)

Polyurethane Tubing (Series 95U) Maximum Working Pressure (psi)

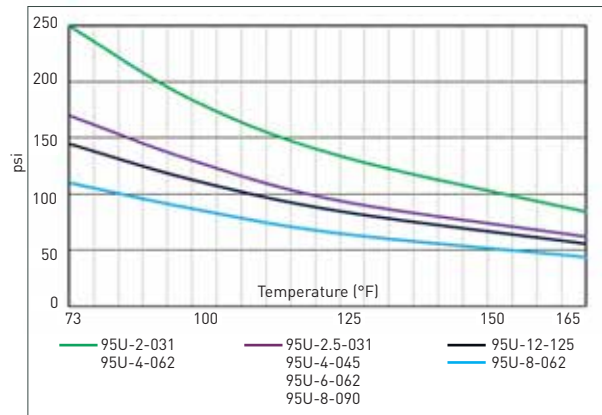

Polyurethane Metric Tubing (Series 95UM) Maximum Working Pressure (bar)

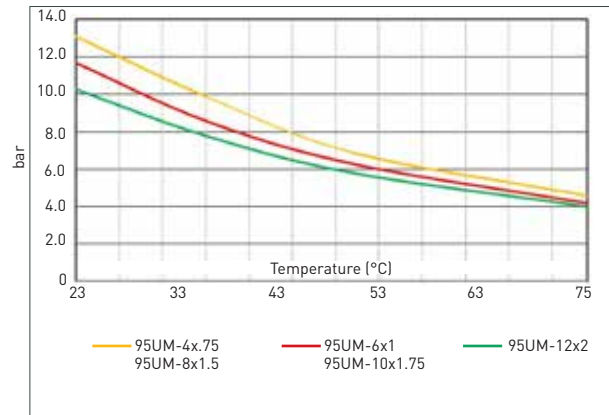

Fittings

Parker Fittings available from:
Fluid System Connectors Division
Otsego, MI

(269) 692-6555
(269) 692-6634 FAX
parker.com/fsc

For approved fittings and/or suggested use of tube supports, reference Tube/Fitting Compatibility Chart (pg. B-8/B-9) or contact Parker Fluid Systems Connectors Division



WARNING

This product can expose you to chemicals including Carbon-black compounds, which is known to the State of California to cause cancer, and Toluene, which is known to the State of California to cause birth defects or other reproductive harm. For more information go to www.P65Warnings.ca.gov.

Example: 95U-2-031-RED-0100

95U-2-031-RED-0100 – 95 Durometer Polyurethane
 95U-2-031-RED-0100 – **Tube O.D.** sixteenths of an inch (**1/8"**)
 95U-2-031-RED-0100 – **Wall Thickness** in inches (**.031"**)
 95U-2-031-RED-0100 – **Color**
 95U-2-031-RED-0100 – **Package Quantity** in feet (**100'**)

Polyurethane Tubing

Series 95U/95UM: Polyether Base

Series 95U: PU Tubing - Natural and Colors

Part Number	Nominal O.D.		Nominal I.D.		Average Wall Thickness		Working Pressure 73°F (23°C)		Minimum Burst Pressure		Weight		Color
	inch	mm	inch	mm	inch	mm	psi	bar	psi	bar	lbs./ft.	kg/mtr	
95U-2-031-XXX-0100 95U-2-031-XXX-0500	1/8	3.2	.063	1.6	.031	0.80	250	17.2	750	51.6	.005	.007	○ ● ● ● ● ● ● ●
95U-2.5-031-XXX-0100 95U-2.5-031-XXX-0500	5/32	4.0	.094	2.4	.031	0.80	170	11.7	510	35.1	.006	.009	○ ● ● ● ● ● ● ●
95U-4-045-XXX-1000	1/4	6.4	.160	4.1	.045	1.10	170	11.7	510	35.1	.015	.023	○
95U-4-062-XXX-0100 95U-4-062-XXX-0500 95U-4-062-XXX-1000	1/4	6.4	.125	3.2	.062	1.60	250	17.2	750	51.6	.019	.028	○ ● ● ● ● ● ● ●
95U-6-062-XXX-0100 95U-6-062-XXX-0500	3/8	9.5	.250	6.4	.062	1.60	170	11.7	510	35.1	.030	.045	○ ● ● ● ● ● ● ●
95U-8-062-XXX-0100 95U-8-062-XXX-0250	1/2	12.7	.375	9.5	.062	1.60	110	7.6	330	22.8	.042	.063	○ ● ● ● ● ● ● ●
95U-8-090-XXX-0100 95U-8-090-XXX-0250	1/2	12.7	.320	8.1	.090	2.30	170	11.7	510	35.1	.059	.089	○ ● ● ● ● ● ● ●
95U-12-125-XXX-0100	3/4	19.1	.500	12.7	.125	3.20	145	10.0	435	30.0	.125	.188	○

Series 95UM: PU Metric Size Tubing - Natural and Colors

Part Number	Nominal O.D.		Nominal I.D.		Average Wall Thickness		Working Pressure 73°F (23°C)		Minimum Burst Pressure		Weight		Color
	mm	inch	mm	inch	inch	mm	bar	psi	bar	psi	kg/mtr	lbs./ft.	
95UM-4x.75-XXX-0100 95UM-4x.75-XXX-0500	4	.157	2.5	.098	0.75	.030	13.1	190	39.3	570	.009	.006	○ ● ● ● ● ● ● ●
95UM-6x1-XXX-0100 95UM-6x1-XXX-0500	6	.236	4.0	.157	1.00	.039	11.7	170	35.1	510	.019	.013	○ ● ● ● ● ● ● ●
95UM-8x1.5-XXX-0100 95UM-8x1.5-XXX-0500	8	.315	5.0	.196	1.50	.059	13.1	190	39.3	570	.036	.024	○ ● ● ● ● ● ● ●
95UM-10x1.75-XXX-0100 95UM-10x1.75-XXX-0500	10	.393	6.5	.256	1.75	.069	11.7	170	35.1	510	.054	.036	○ ● ● ● ● ● ● ●
95UM-12x2-XXX-0100 95UM-12x2-XXX-0500	12	.472	8.0	.315	2.00	.079	10.3	150	30.9	450	.074	.049	○ ● ● ● ● ● ● ●

Colors

Color Code			Color Code		
○	-	Natural	●	YEL	Yellow
●	BLK	Black	●	TBL	Transparent Blue
●	BLU	Blue	●	TGR	Transparent Green
●	GRA	Gray	●	TRD	Transparent Red
●	GRN	Green	●	TYL	Transparent Yellow
●	RED	Red			
○	WHT	White			

Example: 95UM-6x1-BLK-0100

95UM-6x1-BLK-0100 – 95 Durometer Polyurethane
 95UM-6x1-BLK-0100 – Tube O.D. in millimeters (6mm)
 95UM-6x1-BLK-0100 – Tube I.D. in millimeters (1mm)
 95UM-6x1-BLK-0100 – Color Black (Omit for Natural)
 95UM-6x1-BLK-0100 – Package Quantity in feet (100')

WARNING
 This product can expose you to chemicals including Carbon-black compounds, which is known to the State of California to cause cancer, and Toluene, which is known to the State of California to cause birth defects or other reproductive harm. For more information go to www.P65Warnings.ca.gov.

MicroWeld™ Tubing

Series 95FR: Flame Resistant

Weld spatter resistance and excellent flexibility.



Features

- 95 Shore A durometer core tube
- Easily skived flame resistant jacket protects core tube for extended life
- Silicone and halogen free
- Excellent flexibility
- Weld spatter resistant
- Ideal for air/water supply in robotic welding applications

Compliance

- UL-94 V0 compliant jacket material

Notes

- Suggested operating temperature range is -40°F (-18°C) to 165°F (74°C) - reference Pressure vs. Temperature charts as pressures are lower at elevated temperatures
- Working pressure and burst pressure are at 73°F (23°C)

MicroWeld Tubing (Series 95FR) Maximum Working Pressure (psi)

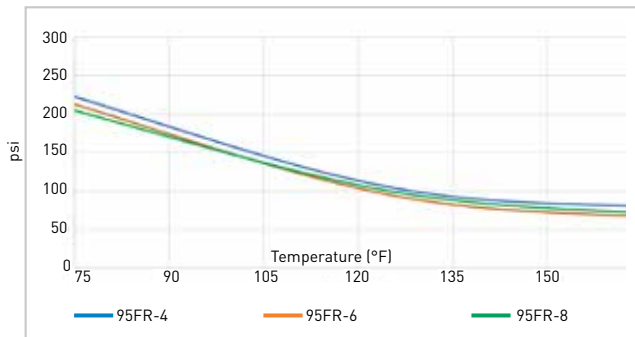

MicroWeld Metric Tubing (Series 95FRM) Maximum Working Pressure (bar)

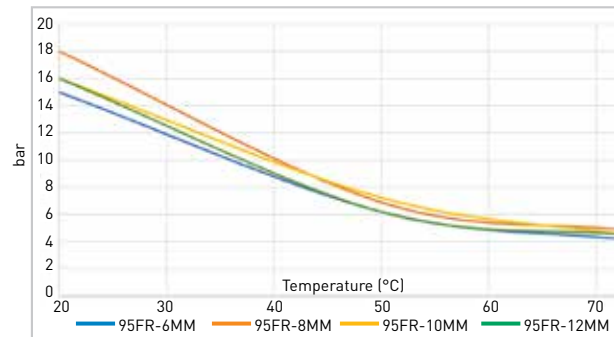

Fittings

Parker Fittings available from:
Fluid System Connectors Division
Otsego, MI

(269) 692-6555
(269) 692-6634 FAX
parker.com/fsc

For approved fittings and/or suggested use of tube supports, reference Tube/Fitting Compatibility Chart (pg. B-8/B-9) or contact Parker Fluid Systems Connectors Division

Order Information

Example: 95FR-4-BLU-0250

- 95FR-4-BLU-0250 – Flame Resistant Polyurethane
- 95FR-4-BLU-0250 – Tube O.D. in sixteenths of an inch (1/4")
- 95FR-4-BLU-0250 – Blue
- 95FR-4-BLU-0250 – Package Quantity in feet (250')



WARNING

This product can expose you to chemicals including Antimony Oxide (Antimony Trioxide), which is known to the State of California to cause cancer. For more information go to www.P65Warnings.ca.gov.

MicroWeld™ Tubing

Series 95FR: Flame Resistant

Series 95FR: Jacketed, Fire Resistant Polyurethane Tubing

Part Number	Nominal O.D.		Nominal I.D.		Average Wall Thickness		Final Sheath O.D.		Final Sheath Wall Thickness		Working Pressure 73°F (23°C)		Minimum Burst Pressure		Minimum Bend Radius		Weight		Color
	inch	mm	inch	mm	inch	mm	inch	mm	inch	mm	psi	bar	psi	bar	inch	mm	lbs./ft.	kg/mtr	
95FR-4-XXX-0250	1/4	6.4	.125	3.2	.045	1.1	.340	8.6	.045	1.1	240	16.5	720	49.6	3/4	19.0	.042	.062	● ● ● ● ●
95FR-4-XXX-0500		● ● ● ● ●																	
95FR-6-XXX-0250	3/8	9.5	.250	6.4	.062	1.6	.465	11.8	.045	1.1	230	15.9	690	47.6	1	25.5	.069	.103	● ● ● ● ●
95FR-6-XXX-0500		● ● ● ● ●																	
95FR-8-XXX-0250	1/2	12.7	.320	8.1	.090	2.3	.590	15.0	.045	1.1	220	15.2	660	45.5	2	51.0	.108	.161	● ● ● ● ●

Series 95FRM: Jacketed, Fire Resistant Metric Polyurethane Tubing

Part Number	Nominal O.D.		Nominal I.D.		Average Wall Thickness		Final Sheath O.D.		Final Sheath Wall Thickness		Working Pressure 73°F (23°C)		Minimum Burst Pressure		Minimum Bend Radius		Weight		Color
	mm	inch	mm	inch	mm	inch	mm	inch	mm	inch	bar	psi	bar	psi	mm	inch	kg/mtr	lbs./ft.	
95FRM-6MM-XXX-0250	6	.236	4.0	.157	1.00	.039	8.0	.315	1.1	.045	15	218	45	652	20.0	3/4	.057	.038	● ● ● ● ●
95FRM-6MM-XXX-0500		● ● ● ● ●																	
95FRM-8MM-XXX-0250	8	.315	5.0	.197	1.50	.059	10.0	.394	1.1	.045	18	261	54	783	22.0	7/8	.085	.057	● ● ● ● ●
95FRM-8MM-XXX-0500		● ● ● ● ●																	
95FRM-10MM-XXX-0500	10	.394	6.5	.256	1.75	.069	12.0	.472	1.1	.045	16	232	48	696	26.0	1	.113	.076	● ● ● ● ●
95FRM-12MM-XXX-0500	12	.472	8.0	.315	2.00	.079	14.0	.551	1.1	.045	16	232	48	696	32.0	1-1/4	.144	.097	● ● ● ● ●

Colors

Color Code		
●	BLK	Black
●	BLU	Blue
●	GRA	Gray
●	GRN	Green
●	RED	Red
○	WHT	White



WARNING

This product can expose you to chemicals including Antimony Oxide (Antimony Trioxide), which is known to the State of California to cause cancer. For more information go to www.P65Warnings.ca.gov.

Vinyl Tubing

Series PV: Clear Vinyl Tubing

Instrument and laboratory grade
PVC tubing.



Features

- Made from a virgin clear PVC (polyvinyl chloride) resin; specifically formulated for exceptional purity, clarity and flexibility
- 70 durometer for soft, easy handling and bending without tubing collapse

Compliance

- FDA, CFR21 Part 177 Compliant for Food Contact

Notes

- Formula V-1 tubing fully meets all specifications called out by the United States Food and Drug Administration (FDA) for materials in contact with food and drugs for human consumption
- Phthalate free construction
- Suggested operating temperature range is -40°F (-18°C) to 150°F (65°C - reference Pressure vs. Temperature charts as pressures are lower at elevated temperatures
- Working pressure and burst pressure are at 73°F (23°C)

Fittings

Parker Fittings available from:
Fluid System Connectors Division
Otsego, MI

[269] 692-6555
[269] 692-6634 FAX
parker.com/fsc

For approved fittings and/or suggested use of tube supports, reference Tube/Fitting Compatibility Chart (pg. B-8/B-9) or contact Parker Fluid Systems Connectors Division

Order Information

Example: PV108-1

PV108-1 – Poly-Vinyl

PV108-1 – **Tube O.D.** in sixteenths of an inch (**5/8"**)

PV108-1 – **Tube I.D.** in sixteenths of an inch (**1/2"**)

PV108-1 – **Formula V-1 FDA Approved Formulation**



WARNING

This product can expose you to chemicals including Di (2-ethylhexyl) phthalate (DEHP), which is known to the State of California to cause cancer and birth defects or other reproductive harm. For more information go to www.P65Warnings.ca.gov.

Vinyl Tubing

Series PV: Clear Vinyl Tubing

Series PV - Vinyl Tubing

Part Number	Tube O.D.		Tube I.D.		Average Wall Thickness		Working Pressure 73°F (23°C)		Package Qty	Weight	
	inch	mm	inch	mm	inch	mm	psi	bar		ft	lbs./ft.
PV21-1	1/8	3.2	.063	1.6	.031	0.8	35	2.4	100	.005	.007
PV32-1	.170	4.3	.125	3.2	.025	0.6	35	2.4	100	.006	.009
PV42-1	1/4	6.4	.125	3.2	.063	1.6	65	4.5	100	.025	.037
PV43-1	1/4	6.4	.170	4.3	.040	1.2	55	3.8	100	.014	.021
PV403-1	1/4	6.4	.188	4.8	.031	0.8	22	1.5	100	.011	.016
PV53-1	5/16	7.9	.188	4.8	.063	1.6	55	3.8	100	.025	.037
PV63-1	3/8	9.5	.188	4.8	.094	2.4	65	4.5	100	.043	.064
PV73-1	7/16	11.1	.188	4.8	.125	3.2	75	5.2	100	.063	.094
PV54-1	5/16	7.9	.250	6.4	.031	0.8	20	1.4	100	.014	.021
PV64-1	3/8	9.5	.250	6.4	.064	1.6	55	3.8	100	.032	.048
PV74-1	7/16	11.1	.250	6.4	.094	2.4	60	4.1	100	.052	.077
PV84-1	1/2	12.7	.250	6.4	.125	3.2	70	4.8	100	.076	.113
PV75-1	7/16	11.1	.313	7.9	.063	1.6	50	3.4	100	.038	.057
PV85-1	1/2	12.7	.313	7.9	.094	2.4	60	4.1	100	.062	.092
PV95-1	9/16	14.3	.313	7.9	.125	3.2	70	4.8	100	.088	.131
PV86-1	1/2	12.7	.375	9.5	.063	1.6	45	3.1	100	.044	.065
PV96-1	9/16	14.3	.375	9.5	.094	2.4	50	3.4	100	.071	.106
PV106-1	5/8	15.9	.375	9.5	.125	3.2	60	4.1	100	.101	.150
PV97-1	9/16	14.3	.438	11.1	.063	1.6	40	2.8	100	.050	.074
PV107-1	5/8	15.9	.438	11.1	.094	2.4	45	3.1	100	.080	.119
PV117-1	11/16	17.5	.438	11.1	.125	3.2	50	3.4	100	.115	.171
PV108-1	5/8	15.9	.500	12.7	.063	1.6	30	2.1	100	.057	.085
PV118-1	11/16	17.5	.500	12.7	.094	2.4	40	2.8	100	.089	.132
PV128-1	3/4	19.1	.500	12.7	.125	3.2	45	3.1	100	.126	.188
PV138-1	13/16	20.7	.500	12.7	.156	4.0	60	4.1	100	.167	.249
PV129-1	3/4	19.1	.563	14.3	.094	2.4	40	2.8	100	.099	.147
PV139-1	13/16	20.7	.563	14.3	.125	3.2	45	3.1	100	.138	.205

Colors

Color Code		
○	-	Natural



WARNING

This product can expose you to chemicals including Di (2-ethylhexyl) phthalate (DEHP), which is known to the State of California to cause cancer and birth defects or other reproductive harm. For more information go to www.P65Warnings.ca.gov.

Vinyl Tubing

Series PV

Series PV - Vinyl Tubing

Part Number	Tube O.D.		Tube I.D.		Average Wall Thickness		Working Pressure 73°F (23°C)		Package Qty	Weight	
	inch	mm	inch	mm	inch	mm	psi	bar		ft	lbs./ft.
PV1310-1	13/16	20.7	.625	15.9	.094	2.4	35	2.4	100	.108	.161
PV1410-1	7/8	22.2	.625	15.9	.125	3.2	40	2.8	100	.151	.225
PV1510-1	15/16	23.8	.625	15.9	.156	4.0	50	3.5	100	.196	.292
PV1411-1	7/8	22.2	.688	17.5	.094	2.4	30	2.1	100	.118	.176
PV1611-1	1	25.4	.688	17.5	.156	4.0	45	3.1	100	.213	.317
PV1612-1	1	25.4	.750	19.1	.125	3.2	35	2.4	100	.176	.262
PV1712-1	1-1/16	27	.750	19.1	.156	4.0	35	2.4	100	.228	.339
PV1812-1	1-1/8	28.6	.750	19.1	.188	4.8	50	3.5	100	.283	.421
PV2012-1	1-1/4	31.8	.750	19.1	.250	6.4	55	3.8	50	.409	.609
PV1814-1	1-1/8	28.6	.875	22.2	.125	3.2	30	2.1	50	.201	.299
PV1914-1	1-3/16	30.2	.875	22.2	.156	4.0	35	2.4	50	.259	.385
PV2014-1	1-1/4	31.8	.875	22.2	.188	4.8	45	3.1	50	.321	.478
PV2016-1	1-1/4	31.8	1.000	25.4	.125	3.2	25	1.7	50	.230	.342
PV2116-1	1-5/16	33.4	1.000	25.4	.156	4.0	30	2.1	50	.291	.433
PV2216-1	1-3/8	34.9	1.000	25.4	.188	4.8	40	2.8	50	.359	.534
PV2416-1	1-1/2	38.1	1.000	25.4	.250	6.4	45	3.1	50	.514	.765
PV2218-1	1-3/8	34.9	1.125	28.6	.125	3.2	25	1.7	50	.252	.375
PV2420-1	1-1/2	38.1	1.250	31.8	.125	3.2	20	1.4	50	.277	.412
PV2620-1	1-5/8	41.3	1.250	31.8	.188	4.8	35	2.4	50	.434	.646
PV2820-1	1-3/4	44.4	1.250	31.8	.250	6.4	45	3.1	50	.604	.899
PV3024-1	1-7/8	47.6	1.500	38.1	.188	4.8	30	2.1	50	.510	.759
PV3224-1	2	50.8	1.500	38.1	.250	6.4	40	2.8	50	.705	1.05
PV3628-1	2-1/4	57.2	1.750	44.4	.250	6.4	30	2.1	50	.806	1.20
PV4032-1	2-1/2	63.5	2.000	50.8	.250	6.4	35	2.4	50	.906	1.35



WARNING

This product can expose you to chemicals including Di (2-ethylhexyl) phthalate (DEHP), which is known to the State of California to cause cancer and birth defects or other reproductive harm. For more information go to www.P65Warnings.ca.gov.

PTFE Tubing

Series 101, 201: Fractional & Metric

Best chemical and corrosion resistance available.



Features

- Virgin Polytetrafluoroethylene resin
- Chemically inert
- Lowest coefficient of friction
- Superior dielectric strength
- Exceptional heat resistance
- Self extinguishing
- Non-wetting
- Excellent flexlife
- Laser markable

Compliance

- AMS 3653
- 21 CFR 177.1550 Compliant
- USP Class VI Compliant
- UL94V-0

Notes

- Working Temperature: °F (-73°C) to 500°F (260°C)
- Vacuum Rating 28 @ 73°F
- Working pressure calculated using a Design Factor of 4

PTFE Tubing (Series 101, 201) Maximum Working Pressure (psi)

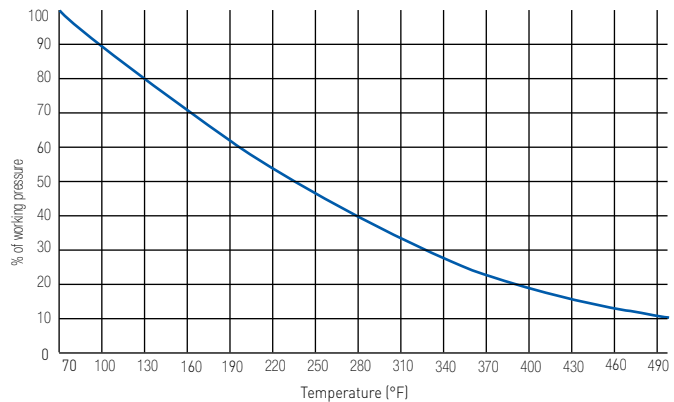

Fittings

Parker Fittings available from:
Fluid System Connectors Division
Otsego, MI

(269) 692-6555
(269) 692-6634 FAX
parker.com/fsc

For approved fittings and/or suggested use of tube supports, reference Tube/Fitting Compatibility Chart (pg. B-8/B-9) or contact Parker Fluid Systems Connectors Division

Order Information

Example: 101-0188062-0TC-100

- 101-0188062-0TC-100 – PTFE
- 101-0188062-0TC-100 – Tube O.D. in inches (3/16")
- 101-0188062-0TC-100 – Tube Wall Thickness in inches (.062")
- 101-0188062-0TC-100 – Black
- 101-0188062-0TC-100 – Bulk Tubing
- 101-0188062-0TC-100 – Solid Color Tube
- 101-0188062-0TC-100 – Package Quantity in feet (100')



WARNING

This product can expose you to chemicals including Tetrafluoroethylene, which is known to the State of California to cause cancer. For more information go to www.P65Warnings.ca.gov.

PTFE Tubing

Series 101

Series 101 - PTFE Fractional Industrial Wall Tubing

Part Number	Order Size	Nominal O.D.				Nominal I.D.				Reference Wall Thickness		Working Pressure 73°F (23°C)		Minimum Burst Pressure		Minimum Bend Radius		Vac. Rating	Weight	
		inch	inch	tol.	mm	tol.	inch	tol.	mm	tol.	inch	mm	psi	bar	psi	bar	inch		mm	lb./ft.
101-0094031	3/32	0.094	± 0.005	2.40	± 0.13	0.031	± 0.002	0.79	± 0.05	0.031	0.79	390	27	1560	108	0.500	13	28	0.006	0.009
101-0125031	1/8	0.125	± 0.005	3.18	± 0.13	0.063	± 0.003	1.57	± 0.05	0.031	0.79	290	20	1160	80	0.500	13	28	0.009	0.013
101-0156031	5/32	0.156	± 0.005	3.99	± 0.13	0.094	± 0.004	2.39	± 0.08	0.031	0.79	220	15	880	61	0.625	16	28	0.011	0.016
101-0188031	3/16	0.188	± 0.005	4.78	± 0.13	0.125	± 0.005	3.18	± 0.13	0.031	0.79	180	12	720	50	0.750	19	28	0.014	0.021
101-0250031	1/4	0.250	± 0.005	6.35	± 0.13	0.190	± 0.005	4.83	± 0.13	0.031	0.79	130	9	520	36	1.000	25	28	0.020	0.030
101-0312031	5/16	0.312	± 0.005	7.92	± 0.13	0.250	± 0.007	6.35	± 0.18	0.031	0.79	100	7	400	28	2.250	57	28	0.026	0.039
101-0375031	3/8	0.375	± 0.005	9.52	± 0.13	0.312	± 0.006	7.92	± 0.15	0.031	0.79	80	6	320	22	2.750	70	28	0.032	0.048
101-0438031	7/16	0.438	± 0.005	11.13	± 0.13	0.375	± 0.007	9.52	± 0.18	0.031	0.79	70	5	280	19	4.000	102	28	0.037	0.055
101-0500031	1/2	0.500	± 0.006	12.70	± 0.15	0.438	± 0.008	11.13	± 0.20	0.031	0.79	60	4	240	17	4.000	102	28	0.043	0.064
101-0563031	9/16	0.563	± 0.007	14.30	± 0.18	0.500	± 0.010	12.70	± 0.25	0.031	0.79	55	4	220	15	5.000	127	28	0.049	0.073
101-0625031	5/8	0.625	± 0.007	15.88	± 0.18	0.563	± 0.010	14.30	± 0.25	0.031	0.79	50	3	200	14	5.500	140	28	0.054	0.080
101-0688031	11/16	0.688	± 0.010	17.48	± 0.25	0.625	± 0.012	15.88	± 0.31	0.031	0.79	45	3	180	12	6.250	159	28	0.060	0.089
101-0750032	3/4	0.750	± 0.010	19.05	± 0.25	0.688	± 0.012	17.48	± 0.31	0.032	0.81	40	3	160	11	6.500	165	28	0.068	0.101
101-0830040	0.830	0.830	± 0.014	21.08	± 0.36	0.750	± 0.014	19.05	± 0.36	0.040	1.02	45	3	180	12	8.000	203	28	0.093	0.138
101-0965045	0.965	0.965	± 0.016	24.51	± 0.41	0.875	± 0.016	22.22	± 0.41	0.045	1.14	45	3	180	12	12.000	305	28	0.122	0.182
101-1100050	1.100	1.100	± 0.020	27.94	± 0.51	1.000	± 0.020	25.40	± 0.51	0.050	1.27	40	3	160	11	18.000	457	28	0.155	0.231

Series 101 - PTFE Fractional Heavy Wall Tubing

101-0188062	3/16	.188	± .005	4.78	± 0.13	0.063	± 0.003	1.57	± 0.05	0.062	1.57	390	27	1560	108	0.250	6	28	0.023	0.034
101-0250047	1/4	.250	± .005	6.35	± 0.13	0.157	± 0.005	3.99	± 0.13	0.047	1.19	210	14	840	58	0.625	16	28	0.028	0.042
101-0250062	1/4	.250	± .005	6.35	± 0.13	0.125	± 0.005	3.18	± 0.13	0.062	1.57	290	20	1160	80	0.500	13	28	0.034	0.051
101-0312062	5/16	.312	± .005	7.92	± 0.13	0.188	± 0.006	4.76	± 0.15	0.062	1.57	222	15	888	61	0.875	22	28	0.046	0.068
101-0375062	3/8	.375	± .005	9.52	± 0.13	0.250	± 0.005	6.35	± 0.13	0.062	1.57	180	12	720	50	1.000	25	28	0.057	0.085
101-0438062	7/16	.438	± .005	11.13	± 0.13	0.312	± 0.007	7.92	± 0.18	0.062	1.57	150	10	600	41	2.250	57	28	0.069	0.103
101-0500062	1/2	.500	± .005	12.70	± 0.13	0.375	± 0.005	9.52	± 0.13	0.062	1.57	130	9	520	36	2.250	57	28	0.080	0.119
101-0563062	9/16	.563	± .007	14.30	± 0.18	0.437	± 0.008	11.13	± 0.20	0.062	1.57	110	8	440	30	2.750	70	28	0.092	0.137
101-0625062	5/8	.625	± .007	15.88	± 0.18	0.500	± 0.010	12.70	± 0.25	0.062	1.57	100	7	400	28	3.000	76	28	0.103	0.153
101-0688062	11/16	.688	± .010	17.48	± 0.25	0.563	± 0.010	14.30	± 0.25	0.062	1.57	90	6	360	25	5.000	127	28	0.115	0.171
101-0750062	3/4	.750	± .010	19.05	± 0.25	0.625	± 0.010	15.88	± 0.25	0.062	1.57	80	6	320	22	6.000	152	28	0.126	0.188
101-0875062	7/8	.875	± .014	22.22	± 0.36	0.750	± 0.014	19.05	± 0.36	0.062	1.57	70	5	280	19	7.250	184	28	0.149	0.222
101-1000062	1	1.000	± .016	25.40	± 0.25	0.875	± 0.016	22.22	± 0.36	0.062	1.57	100	6.9	400	28	8.000	203	28	0.172	0.256

Colors

- Standard is natural
- Colors available as custom run

Color Code			Color Code		
○	N	Natural	●	5	Green
●	0	Black	●	6	Blue
●	1	Brown	●	7	Violet
●	2	Red	●	8	Gray
●	3	Orange	○	9	White
●	4	Yellow			



WARNING

This product can expose you to chemicals including Tetrafluoroethylene, which is known to the State of California to cause cancer. For more information go to www.P65Warnings.ca.gov.

PTFE Tubing

Series 201

Series 201 - PTFE Metric Size Tubing

Part Number	Order Size	Nominal O.D.				Nominal I.D.				Reference Wall Thickness		Working Pressure 73°F (23°C)		Minimum Burst Pressure		Minimum Bend Radius		Vac. Rating	Weight	
		mm	mm	tol.	inch	tol.	mm	tol.	inch	tol.	mm	inch	bar	psi	bar	psi	mm		inch	kg/mt
201-0300100	3	3	± 0.11	0.118	± 0.004	1	± 0.11	0.039	± 0.004	1	0.039	27	390	108	1560	13	0.500	28	0.014	0.009
201-0400100	4	4	± 0.11	0.157	± 0.004	2	± 0.11	0.074	± 0.004	1	0.039	20	290	80	1160	13	0.500	28	0.020	0.014
201-0500100	5	5	± 0.11	0.197	± 0.004	3	± 0.11	0.118	± 0.004	1	0.039	15	220	61	880	19	0.750	28	0.027	0.018
201-0600100	6	6	± 0.13	0.236	± 0.005	4	± 0.13	0.157	± 0.005	1	0.039	12	180	50	720	25	1.000	28	0.034	0.023
201-0700100	7	7	± 0.13	0.276	± 0.005	5	± 0.13	0.197	± 0.005	1	0.039	10	150	41	600	38	1.500	28	0.041	0.027
201-0800100	8	8	± 0.13	0.315	± 0.005	6	± 0.13	0.236	± 0.005	1	0.039	9	130	36	520	51	2.000	28	0.048	0.032
201-0900100	9	9	± 0.13	0.354	± 0.005	7	± 0.13	0.276	± 0.005	1	0.039	8	110	30	440	57	2.250	28	0.055	0.037
201-1000100	10	10	± 0.13	0.394	± 0.005	8	± 0.13	0.315	± 0.005	1	0.039	7	100	28	400	64	2.500	28	0.061	0.041
201-1200100	12	12	± 0.15	0.472	± 0.006	10	± 0.15	0.394	± 0.006	1	0.039	6	80	22	320	76	3.000	28	0.075	0.050
201-1400100	14	14	± 0.15	0.551	± 0.006	12	± 0.15	0.472	± 0.006	1	0.039	5	70	19	280	89	3.500	28	0.089	0.060
201-1600100	16	16	± 0.15	0.630	± 0.006	14	± 0.15	0.551	± 0.006	1	0.039	4	60	17	240	108	4.250	28	0.102	0.069

Colors

- Standard is natural
- Colors available as custom run

Color Code			Color Code		
○	N	Natural	●	5	Green
●	0	Black	●	6	Blue
●	1	Brown	●	7	Violet
●	2	Red	●	8	Gray
●	3	Orange	○	9	White
●	4	Yellow			



WARNING

This product can expose you to chemicals including Tetrafluoroethylene, which is known to the State of California to cause cancer. For more information go to www.P65Warnings.ca.gov.

Tubing
 Fluoropolymer
 Coiled Air Hose
 & Fittings
 Transportation
 Fittings
 Tooling,
 Equipment
 & Accessories
 General
 Technical

PTFE Tubing

Series AWG TFH, TFS, TFT, TFL

Best chemical and corrosion resistance available.



Features

- Virgin Polytetrafluoroethylene resin
- Chemically inert
- Lowest coefficient of friction
- Superior dielectric strength
- Exceptional heat resistance
- Self extinguishing
- Non-wetting
- Excellent flexlife
- Laser markable

Notes

- Working Temperature: °F (-73°C) to 500°F (260°C)
- AWG Spaghetti tubing is supplied in 1,000 foot spools
- AWG - *Add -UL suffix to part number for UL VW-1 rated product (ie. TFS12-2TC-UL)
- Custom packaging, sizes and lengths are quoted upon request

Fittings

Parker Fittings available from:
Fluid System Connectors Division
Otsego, MI

[269] 692-6555
[269] 692-6634 FAX
parker.com/fsc

For approved fittings and/or suggested use of tube supports, reference Tube/Fitting Compatibility Chart (pg. B-8/B-9) or contact Parker Fluid Systems Connectors Division

Compliance

- AMS 3653
- 21 CFR 177.1550 Compliant
- USP Class VI Compliant
- Light Wall (TFL) – ASTM D3295 Class 1, UL-224 150V 200°C
- Thin Wall (TFT) – ASTM D3295 Class 2, AMS 3655, UL-224 300V 200°C, CSA 9032-01 300V
- Standard Wall (TFS) –UL-224 600V 200°C, CSA 9032-01 600V
- Heavy Wall (TFH) – ASTM D3295, Class 4
- UL94V-0

Order Information

Example: TFH13-2TC

TFH13-2TC – **PTFE**

TFH13-2TC – **Tube Wall Thickness H = Heavy**

TFH13-2TC – **Tube Size - AWG 13**

TFH13-2TC – **Red**

TFH13-2TC – **Bulk Tubing**

TFH13-2TC – **Solid Color Tube**



WARNING

This product can expose you to chemicals including Tetrafluoroethylene, which is known to the State of California to cause cancer. For more information go to www.P65Warnings.ca.gov.

PTFE AWG Tubing

Series TFH

Series TFH - PTFE AWG Heavy Wall Tubing

Part Number	Order Size AWG	Nominal I.D.		Minimum I.D.		Maximum I.D.		Nominal Wall		Weight		Standard Packaging
		inch	mm	inch	mm	inch	mm	inch	mm	lb/ft	kg/mtr	
TFH24	24	0.022	0.56	0.020	0.51	0.026	0.66	0.016	0.41	0.0018	0.0027	1,000 ft. spool
TFH23	23	0.026	0.66	0.023	0.58	0.029	0.74	0.016	0.41	0.0020	0.0030	1,000 ft. spool
TFH22	22	0.028	0.71	0.025	0.64	0.032	0.81	0.016	0.41	0.0021	0.0031	1,000 ft. spool
TFH21	21	0.032	0.81	0.029	0.74	0.035	0.89	0.016	0.41	0.0022	0.0033	1,000 ft. spool
TFH20	20	0.034	0.86	0.032	0.81	0.040	1.02	0.018	0.46	0.0027	0.0040	1,000 ft. spool
TFH19	19	0.038	0.97	0.036	0.91	0.044	1.12	0.020	0.51	0.0034	0.0051	1,000 ft. spool
TFH18	18	0.042	1.07	0.040	1.02	0.049	1.25	0.020	0.51	0.0036	0.0054	1,000 ft. spool
TFH17	17	0.048	1.22	0.045	1.14	0.054	1.37	0.020	0.51	0.0040	0.0060	1,000 ft. spool
TFH16	16	0.053	1.35	0.051	1.3	0.061	1.55	0.020	0.51	0.0043	0.0064	1,000 ft. spool
TFH15	15	0.059	1.50	0.057	1.45	0.067	1.70	0.020	0.51	0.0046	0.0068	1,000 ft. spool
TFH14	14	0.066	1.68	0.064	1.63	0.074	1.88	0.020	0.51	0.0050	0.0074	500 ft. spool
TFH13	13	0.076	1.93	0.072	1.83	0.082	2.08	0.020	0.51	0.0056	0.0083	500 ft. spool
TFH12	12	0.085	2.16	0.081	2.06	0.091	2.31	0.020	0.51	0.0061	0.0091	500 ft. spool
TFH11	11	0.095	2.41	0.091	2.31	0.101	2.57	0.020	0.51	0.0067	0.0100	500 ft. spool
TFH10	10	0.106	2.69	0.102	2.59	0.112	2.84	0.025	0.64	0.0096	0.0143	500 ft. spool
TFH09	9	0.118	3.00	0.114	2.90	0.124	3.15	0.025	0.64	0.0105	0.0156	500 ft. spool
TFH08	8	0.133	3.38	0.129	3.28	0.141	3.58	0.030	0.76	0.0143	0.0213	random length coils
TFH07	7	0.148	3.76	0.144	3.66	0.158	4.01	0.030	0.76	0.0156	0.0232	random length coils
TFH06	6	0.166	4.22	0.162	4.11	0.178	4.52	0.030	0.76	0.0172	0.0256	random length coils
TFH05	5	0.185	4.70	0.182	4.62	0.196	4.98	0.032	0.81	0.0203	0.0302	random length coils

Colors

- Standard is natural
- Colors available as custom run

Color Code			Color Code		
○	N	Natural	●	5	Green
●	0	Black	●	6	Blue
●	1	Brown	●	7	Violet
●	2	Red	●	8	Gray
●	3	Orange	○	9	White
●	4	Yellow			



WARNING

This product can expose you to chemicals including Tetrafluoroethylene, which is known to the State of California to cause cancer. For more information go to www.P65Warnings.ca.gov.

PTFE AWG Tubing

Series TFS

Series TFS - PTFE AWG Standard Wall Tubing

Part Number	Order Size AWG	Nominal I.D.		Minimum I.D.		Maximum I.D.		Nominal Wall		Weight		Standard Packaging
		inch	mm	inch	mm	inch	mm	inch	mm	lb/ft	kg/mtr	
TFS30	30	0.012	0.31	0.010	0.25	0.015	0.38	0.009	0.23	0.0006	0.0009	1,000 ft. spool
TFS28	28	0.015	0.38	0.013	0.33	0.018	0.46	0.009	0.23	0.0006	0.0009	1,000 ft. spool
TFS26	26	0.018	0.46	0.016	0.41	0.022	0.56	0.009	0.23	0.0007	0.0010	1,000 ft. spool
TFS24	24	0.022	0.56	0.020	0.51	0.026	0.66	0.012	0.31	0.0012	0.0018	1,000 ft. spool
TFS23	23	0.026	0.66	0.023	0.58	0.029	0.74	0.012	0.31	0.0013	0.0019	1,000 ft. spool
TFS22	22	0.028	0.71	0.025	0.64	0.032	0.81	0.012	0.31	0.0014	0.0021	1,000 ft. spool
TFS21	21	0.032	0.81	0.029	0.74	0.035	0.89	0.012	0.31	0.0015	0.0022	1,000 ft. spool
TFS20	20	0.034	0.86	0.032	0.81	0.040	1.02	0.016	0.41	0.0023	0.0034	1,000 ft. spool
TFS19	19	0.038	0.97	0.036	0.91	0.044	1.12	0.016	0.41	0.0025	0.0037	1,000 ft. spool
TFS18	18	0.042	1.07	0.040	1.02	0.049	1.25	0.016	0.41	0.0270	0.0402	1,000 ft. spool
TFS17	17	0.048	1.22	0.045	1.14	0.054	1.37	0.016	0.41	0.0030	0.0045	1,000 ft. spool
TFS16	16	0.053	1.35	0.051	1.30	0.061	1.55	0.016	0.41	0.0032	0.0048	1,000 ft. spool
TFS15	15	0.059	1.50	0.057	1.45	0.067	1.70	0.016	0.41	0.0059	0.0088	500 ft. spool
TFS14	14	0.066	1.68	0.064	1.63	0.074	1.88	0.016	0.41	0.0038	0.0057	500 ft. spool
TFS13	13	0.076	1.93	0.072	1.83	0.082	2.08	0.016	0.41	0.0043	0.0064	500 ft. spool
TFS12	12	0.085	2.16	0.081	2.06	0.091	2.31	0.016	0.41	0.0047	0.0070	500 ft. spool
TFS11	11	0.095	2.41	0.091	2.31	0.101	2.57	0.016	0.41	0.0052	0.0077	500 ft. spool
TFS10	10	0.106	2.69	0.102	2.59	0.112	2.84	0.016	0.41	0.0057	0.0085	500 ft. spool
TFS09	9	0.118	3.00	0.114	2.90	0.124	3.15	0.020	0.51	0.0081	0.0121	500 ft. spool
TFS08	8	0.133	3.38	0.129	3.28	0.141	3.58	0.020	0.51	0.0090	0.0134	random length coils
TFS07	7	0.148	3.76	0.144	3.66	0.158	4.01	0.020	0.51	0.0098	0.0146	random length coils
TFS06	6	0.166	4.22	0.162	4.11	0.178	4.52	0.020	0.51	0.0109	0.0162	random length coils
TFS05	5	0.185	4.70	0.182	4.62	0.196	4.98	0.020	0.51	0.0120	0.0179	random length coils
TFS04	4	0.208	5.28	0.204	5.18	0.224	5.69	0.020	0.51	0.0133	0.0198	random length coils
TFS03	3	0.234	5.94	0.229	5.82	0.249	6.32	0.020	0.51	0.0149	0.0222	random length coils
TFS02	2	0.263	6.68	0.258	6.55	0.278	7.06	0.020	0.51	0.0166	0.0247	random length coils
TFS01	1	0.294	7.47	0.289	7.34	0.311	7.90	0.020	0.51	0.0184	0.0274	random length coils
TFS00	0	0.330	8.38	0.325	8.25	0.347	8.81	0.020	0.51	0.0205	0.0305	random length coils

Colors

- Standard is natural
- Colors available as custom run

Color Code			Color Code		
○	N	Natural	●	5	Green
●	0	Black	●	6	Blue
●	1	Brown	●	7	Violet
●	2	Red	●	8	Gray
●	3	Orange	○	9	White
●	4	Yellow			



WARNING

This product can expose you to chemicals including Tetrafluoroethylene, which is known to the State of California to cause cancer. For more information go to www.P65Warnings.ca.gov.

PTFE AWG Tubing

Series TFT

Series TFT - PTFE AWG Thin Wall Tubing

Part Number	Order Size AWG	Nominal I.D.		Minimum I.D.		Maximum I.D.		Nominal Wall		Weight		Standard Packaging
		inch	mm	inch	mm	inch	mm	inch	mm	lb/ft	kg/mtr	
TFT32	32	0.010	0.25	0.008	0.20	0.012	0.31	0.007	0.18	0.0003	0.0004	1,000 ft. spool
TFT30	30	0.012	0.31	0.01	0.25	0.015	0.38	0.009	0.23	0.0006	0.0009	1,000 ft. spool
TFT28	28	0.015	0.38	0.013	0.33	0.018	0.46	0.009	0.23	0.0006	0.0009	1,000 ft. spool
TFT26	26	0.018	0.46	0.016	0.41	0.022	0.56	0.009	0.23	0.0007	0.0010	1,000 ft. spool
TFT24	24	0.022	0.56	0.02	0.51	0.026	0.66	0.010	0.25	0.0009	0.0013	1,000 ft. spool
TFT23	23	0.026	0.66	0.023	0.58	0.029	0.74	0.010	0.25	0.0011	0.0016	1,000 ft. spool
TFT22	22	0.028	0.71	0.025	0.64	0.032	0.81	0.010	0.25	0.0011	0.0016	1,000 ft. spool
TFT21	21	0.032	0.81	0.029	0.74	0.035	0.89	0.010	0.25	0.0012	0.0018	1,000 ft. spool
TFT20	20	0.034	0.86	0.032	0.81	0.040	1.02	0.012	0.31	0.0016	0.0024	1,000 ft. spool
TFT19	19	0.038	0.97	0.036	0.91	0.044	1.12	0.012	0.31	0.0018	0.0027	1,000 ft. spool
TFT18	18	0.042	1.07	0.040	1.02	0.049	1.25	0.012	0.31	0.0019	0.0028	1,000 ft. spool
TFT17	17	0.048	1.22	0.045	1.14	0.054	1.37	0.012	0.31	0.0021	0.0031	1,000 ft. spool
TFT16	16	0.053	1.35	0.051	1.30	0.061	1.55	0.012	0.31	0.0023	0.0034	1,000 ft. spool
TFT15	15	0.059	1.50	0.057	1.45	0.067	1.70	0.012	0.31	0.0025	0.0037	1,000 ft. spool
TFT14	14	0.066	1.68	0.064	1.63	0.074	1.88	0.012	0.31	0.0027	0.0040	500 ft. spool
TFT13	13	0.076	1.93	0.072	1.83	0.082	2.08	0.012	0.31	0.0031	0.0046	500 ft. spool
TFT12	12	0.085	2.16	0.081	2.06	0.091	2.31	0.012	0.31	0.0034	0.0051	500 ft. spool
TFT11	11	0.095	2.41	0.091	2.31	0.101	2.57	0.012	0.31	0.0038	0.0057	500 ft. spool
TFT10	10	0.106	2.69	0.102	2.59	0.112	2.84	0.012	0.31	0.0041	0.0061	500 ft. spool
TFT09	9	0.118	3.00	0.114	2.9	0.124	3.15	0.015	0.38	0.0058	0.0086	500 ft. spool
TFT08	8	0.133	3.38	0.129	3.28	0.141	3.58	0.015	0.38	0.0065	0.0097	random length coils
TFT07	7	0.148	3.76	0.144	3.66	0.158	4.01	0.015	0.38	0.0072	0.0107	random length coils
TFT06	6	0.166	4.22	0.162	4.11	0.178	4.52	0.015	0.38	0.0079	0.0118	random length coils
TFT05	5	0.185	4.70	0.182	4.62	0.196	4.98	0.015	0.38	0.0088	0.0131	random length coils
TFT04	4	0.208	5.28	0.204	5.18	0.224	5.69	0.015	0.38	0.0098	0.0146	random length coils
TFT03	3	0.234	5.94	0.229	5.82	0.249	6.32	0.015	0.38	0.0109	0.0162	random length coils
TFT02	2	0.263	6.68	0.258	6.55	0.278	7.06	0.015	0.38	0.0122	0.0182	random length coils
TFT01	1	0.294	7.47	0.289	7.34	0.311	7.90	0.015	0.38	0.0136	0.0202	random length coils
TFT00	0	0.330	8.38	0.325	8.25	0.347	8.81	0.015	0.38	0.0151	0.0225	random length coils

Colors

- Standard is natural
- Colors available as custom run

Color Code			Color Code		
○	N	Natural	●	5	Green
●	0	Black	●	6	Blue
●	1	Brown	●	7	Violet
●	2	Red	●	8	Gray
●	3	Orange	○	9	White
●	4	Yellow			



WARNING

This product can expose you to chemicals including Tetrafluoroethylene, which is known to the State of California to cause cancer. For more information go to www.P65Warnings.ca.gov.

PTFE AWG Tubing

Series TFL

Series TFL - PTFE AWG Light Wall Tubing

Part Number	Order Size AWG	Nominal I.D.		Minimum I.D.		Maximum I.D.		Nominal Wall		Weight		Standard Packaging
		inch	mm	inch	mm	inch	mm	inch	mm	lb/ft	kg/mtr	
TFL32	32	0.010	0.25	0.008	0.20	0.012	0.31	0.005	0.13	0.0002	0.0003	1,000 ft. spool
TFL30	30	0.012	0.31	0.010	0.25	0.015	0.38	0.006	0.13	0.0003	0.0004	1,000 ft. spool
TFL28	28	0.015	0.38	0.013	0.33	0.018	0.46	0.006	0.13	0.0004	0.0006	1,000 ft. spool
TFL26	26	0.018	0.46	0.016	0.41	0.022	0.56	0.006	0.13	0.0004	0.0006	1,000 ft. spool
TFL24	24	0.022	0.56	0.020	0.51	0.026	0.66	0.006	0.13	0.0005	0.0007	1,000 ft. spool
TFL23	23	0.026	0.66	0.023	0.58	0.029	0.74	0.006	0.13	0.0006	0.0009	1,000 ft. spool
TFL22	22	0.028	0.71	0.025	0.64	0.032	0.81	0.006	0.13	0.0006	0.0009	1,000 ft. spool
TFL21	21	0.032	0.81	0.029	0.74	0.035	0.89	0.006	0.13	0.0007	0.0010	1,000 ft. spool
TFL20	20	0.034	0.86	0.032	0.81	0.040	1.02	0.006	0.13	0.0007	0.0010	1,000 ft. spool
TFL19	19	0.038	0.97	0.036	0.91	0.044	1.12	0.006	0.13	0.0008	0.0012	1,000 ft. spool
TFL18	18	0.042	1.07	0.040	1.02	0.049	1.25	0.006	0.13	0.0008	0.0012	1,000 ft. spool
TFL17	17	0.048	1.22	0.045	1.14	0.054	1.37	0.006	0.13	0.0009	0.0013	1,000 ft. spool
TFL16	16	0.053	1.35	0.051	1.30	0.061	1.55	0.006	0.13	0.0010	0.0015	1,000 ft. spool
TFL15	15	0.059	1.50	0.057	1.45	0.067	1.70	0.006	0.13	0.0011	0.0016	1,000 ft. spool
TFL14	14	0.066	1.68	0.064	1.63	0.074	1.88	0.008	0.20	0.0017	0.0025	500 ft. spool
TFL13	13	0.076	1.93	0.072	1.83	0.082	2.08	0.008	0.20	0.0020	0.0030	500 ft. spool
TFL12	12	0.085	2.16	0.081	2.06	0.091	2.31	0.008	0.20	0.0022	0.0033	500 ft. spool
TFL11	11	0.095	2.41	0.091	2.31	0.101	2.57	0.008	0.20	0.0024	0.0036	500 ft. spool
TFL10	10	0.106	2.69	0.102	2.59	0.112	2.84	0.008	0.20	0.0027	0.0040	500 ft. spool
TFL09	9	0.118	3.00	0.114	2.90	0.124	3.15	0.008	0.20	0.0030	0.0045	500 ft. spool
TFL08	8	0.133	3.38	0.129	3.28	0.141	3.58	0.008	0.20	0.0033	0.0049	random length coils
TFL07	7	0.148	3.76	0.144	3.66	0.158	4.01	0.008	0.20	0.0037	0.0055	random length coils
TFL06	6	0.166	4.22	0.162	4.11	0.178	4.52	0.010	0.25	0.0052	0.0077	random length coils
TFL05	5	0.185	4.70	0.182	4.62	0.196	4.98	0.010	0.25	0.0057	0.0085	random length coils
TFL04	4	0.208	5.28	0.204	5.18	0.224	5.69	0.010	0.25	0.0064	0.0095	random length coils
TFL03	3	0.234	5.94	0.229	5.82	0.249	6.32	0.010	0.25	0.0071	0.0106	random length coils
TFL02	2	0.263	6.68	0.258	6.55	0.278	7.06	0.010	0.25	0.0080	0.0119	random length coils
TFL01	1	0.294	7.47	0.289	7.34	0.311	7.90	0.012	0.31	0.0107	0.0159	random length coils
TFL00	0	0.330	8.38	0.325	8.25	0.347	8.81	0.012	0.31	0.0120	0.0179	random length coils

Colors

- Standard is natural
- Colors available as custom run

Color Code			Color Code		
○	N	Natural	●	5	Green
●	0	Black	●	6	Blue
●	1	Brown	●	7	Violet
●	2	Red	●	8	Gray
●	3	Orange	○	9	White
●	4	Yellow			



WARNING

This product can expose you to chemicals including Tetrafluoroethylene, which is known to the State of California to cause cancer. For more information go to www.P65Warnings.ca.gov.

PTFE Beading

Series TFB

Heat resistant beading is a solid profile; ideal for electrical applications.

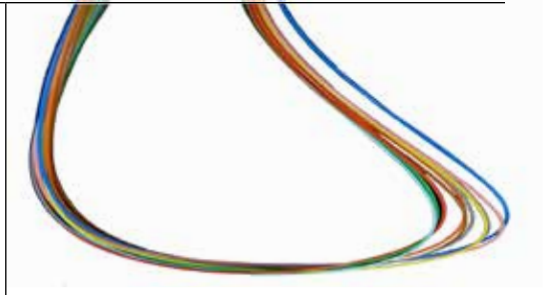

Features

- Virgin Polytetrafluoroethylene resin
- Chemically inert
- Lowest coefficient of friction
- Superior dielectric strength
- Exceptional heat resistance
- Self extinguishing
- Non-wetting
- Excellent flexlife
- Laser markable

Notes

- Working Temperature: °F (-73°C) to 500°F (260°C)
- Vacuum Rating 28 @ 73°F
- Working pressure calculated using a Design Factor of 4

Compliance

- ASTM D1710, Type 1, Grade 1, Class B
- ASTM D3295
- 21 CFR 177.1550 Compliant
- USP Class VI Compliant
- UL94V-0

Colors

- ○ Standard is natural
- Colors available as custom run

Color Code			Color Code		
○	N	Natural	●	5	Green
●	0	Black	●	6	Blue
●	1	Brown	●	7	Violet
●	2	Red	●	8	Gray
●	3	Orange	○	9	White
●	4	Yellow			

Order Information

Example: TFB028-NT

TFB028-NT – PTFE Beading

TFB028-NT – Beading O.D. in inches (0.028")

TFB028-NT – Natural

TFB028-NT – Bulk Tubing



WARNING

This product can expose you to chemicals including Tetrafluoroethylene, which is known to the State of California to cause cancer. For more information go to www.P65Warnings.ca.gov.

PTFE Beading

Series TFB

Series TFB - PTFE Beading (Solid Tube)

Part Number	Diameter		Tolerance		Weight		Standard Packaging
	inch	mm	inch	mm	lb/ft	kg/mtr	
TFB015	0.015	0.38	± 0.002	± 0.05	0.0002	0.0003	1,000 ft. Spool
TFB020	0.020	0.51	± 0.002	± 0.05	0.0003	0.0004	1,000 ft. Spool
TFB025	0.025	0.64	± 0.002	± 0.05	0.0005	0.0007	1,000 ft. Spool
TFB028	0.028	0.71	± 0.002	± 0.05	0.0006	0.0009	1,000 ft. Spool
TFB031	0.031	0.79	± 0.002	± 0.05	0.0007	0.0010	1,000 ft. Spool
TFB035	0.035	0.89	± 0.002	± 0.05	0.0009	0.0013	1,000 ft. Spool
TFB039	0.039	0.99	± 0.002	± 0.05	0.0011	0.0016	1,000 ft. Spool
TFB043	0.043	1.09	± 0.002	± 0.05	0.0014	0.0021	1,000 ft. Spool
TFB047	0.047	1.19	± 0.002	± 0.05	0.0016	0.0024	1,000 ft. Spool
TFB050	0.050	1.27	± 0.002	± 0.05	0.0018	0.0027	1,000 ft. Spool
TFB055	0.055	1.40	± 0.003	± 0.08	0.0022	0.0033	1,000 ft. Spool
TFB060	0.060	1.52	± 0.003	± 0.08	0.0026	0.0039	1,000 ft. Spool
TFB062	0.062	1.57	± 0.003	± 0.08	0.0028	0.0042	1,000 ft. Spool
TFB070	0.070	1.78	± 0.003	± 0.08	0.0036	0.0054	1,000 ft. Spool
TFB072	0.072	1.83	± 0.003	± 0.08	0.0038	0.0057	1,000 ft. Spool
TFB078	0.078	1.98	± 0.004	± 0.10	0.0045	0.0067	500 ft. Spool
TFB080	0.080	2.03	± 0.004	± 0.10	0.0047	0.0070	500 ft. Spool
TFB084	0.084	2.13	± 0.004	± 0.10	0.0052	0.0077	500 ft. Spool
TFB090	0.090	2.29	± 0.004	± 0.10	0.0059	0.0088	500 ft. Spool
TFB094	0.094	2.39	± 0.004	± 0.10	0.0065	0.0097	500 ft. Spool
TFB100	0.100	2.54	± 0.004	± 0.10	0.0073	0.0109	500 ft. Spool
TFB109	0.109	2.77	± 0.004	± 0.10	0.0087	0.0129	500 ft. Spool
TFB115	0.115	2.92	± 0.004	± 0.10	0.0097	0.0144	500 ft. Spool
TFB125	0.125	3.18	± 0.004	± 0.10	0.0114	0.0170	Random Length
TFB150	0.150	3.81	± 0.004	± 0.10	0.0165	0.0246	Random Length
TFB188	0.188	4.78	± 0.004	± 0.10	0.0259	0.0385	Random Length



WARNING

This product can expose you to chemicals including Tetrafluoroethylene, which is known to the State of California to cause cancer. For more information go to www.P65Warnings.ca.gov.

PTFE Spiral Cut Tubing

Series TSWTF

High temperature harnessing for wires and cables.



Features

- Provides harnessing for wires and cable while allowing leads at various points
- Exceptional heat resistance
- Self extinguishing
- Flexible
- Superior dielectric strength

Compliance

- AMS 3653
- ASTM D3295
- UL94V-0

Notes

- Working Temperature: °F [-73°C) to 500°F (260°C)
- Available in left- or right-hand cut. Please specify with proper suffix at end of part number (i.e. TSWTF-1/8-R)

Colors

- ○ Standard is natural
- Colors available as custom run

Color Code			Color Code		
○	N	Natural	●	5	Green
●	0	Black	●	6	Blue
●	1	Brown	●	7	Violet
●	2	Red	●	8	Gray
●	3	Orange	○	9	White
●	4	Yellow			

Fittings

Parker Fittings available from:
Fluid System Connectors Division
Otsego, MI

(269) 692-6555
(269) 692-6634 FAX
parker.com/fsc

For approved fittings and/or suggested use of tube supports, reference Tube/Fitting Compatibility Chart (pg. B-8/B-9) or contact Parker Fluid Systems Connectors Division

Order Information

Example: TSWTF-3/8-5TC-R

TSWTF-3/8-5TC-R – **Spiral Wrap Tubing**

TSWTF-3/8-5TC-R – **PTFE**

TSWTF-**3/8**-5TC-R – **Tube O.D. in inches (3/8")**

TSWTF-3/8-5TC-R – **Green**

TSWTF-3/8-5**TC**-R – **Bulk Tubing**

TSWTF-3/8-5TC-R – **Solid Color**

TSWTF-3/8-5TC-**R** – **Right Hand Cut Spiral**



WARNING

This product can expose you to chemicals including Tetrafluoroethylene, which is known to the State of California to cause cancer. For more information go to www.P65Warnings.ca.gov.

PTFE Spiral Cut Tubing

Series TSWTF

Series TSWTF - PTFE Spiral Cut Tubing

Part Number	Nominal O.D. "A"		Wall Thickness "B"		Pitch "D"		Pitch Tolerance		Maximum Bundle O.D. "C"		Weight	
	inch	mm	inch	mm	inch	mm	psi	bar	inch	mm	lb/ft	kg/mtr
TSWTF-1/8-NT	0.125	3.18	0.020	0.51	0.212	5.38	± 0.015	0.381	1/2	12.7	0.0061	0.0091
TSWTF-3/16-NT	0.188	4.78	0.030	0.76	0.312	7.92	± 0.015	0.381	1	25.4	0.0142	0.0211
TSWTF-1/4-NT	0.250	6.35	0.030	0.76	0.375	9.52	± 0.015	0.381	2	50.8	0.0085	0.0126
TSWTF-3/8-NT	0.375	9.52	0.030	0.76	0.437	11.10	± 0.015	0.381	2-1/2	63.5	0.0317	0.0472
TSWTF-1/2-NT	0.500	12.7	0.030	0.76	0.562	14.27	± 0.015	0.381	3	76.2	0.0426	0.0634
TSWTF-3/4-NT	0.750	19.05	0.040	1.02	0.875	22.22	± 0.015	0.381	4	101.6	0.0831	0.1237
TSWTF-1.00-NT	1.000	25.4	0.040	1.02	1.000	25.40	± 0.015	0.381	6	152.4	0.1124	0.1673

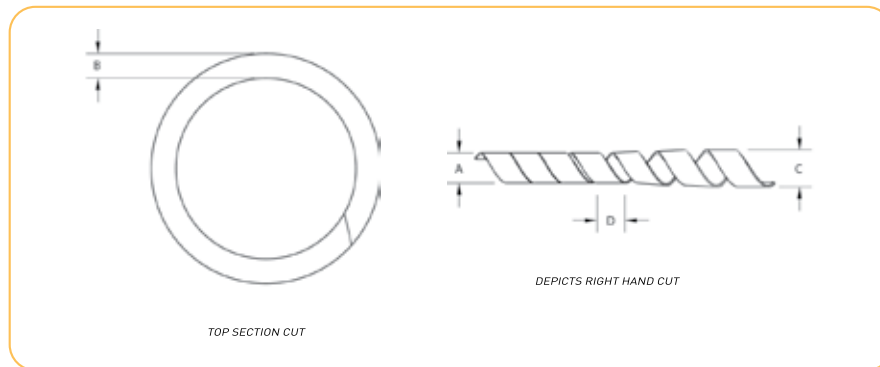

WARNING

This product can expose you to chemicals including Tetrafluoroethylene, which is known to the State of California to cause cancer. For more information go to www.P65Warnings.ca.gov.

PTFE Heat Shrinkable Tubing

Series HS2TFS, HS2TFT, HS2TFL, HS2TFI, HS4TFI

Supplied expanded, allowing easy slippage over instruments, fittings and other protrusions.

2:1 Heat Shrink Ratio
4:1 Heat Shrink Ratio



Features

- Virgin Polytetrafluoroethylene resin
- 2:1 Shrink Ratio
- Chemically inert
- Lowest coefficient of friction
- Superior dielectric strength
- Exceptional heat resistance
- Self extinguishing
- Non-wetting

Compliance

- ASTM 2902 Type I
- AMS 3653
- 21 CFR 177.1550 Compliant
- USP Class VI
- AS23053/12
- UL94V-0

Notes

- Working Temperature: °F (-73°C) to 500°F (260°C)
- Shrink Temperature: 662°F (350°C) for 10 minutes per AMS-DTL-23053/12A
- *Dielectric Strength: > 800 v/m, per ASTM D 149 short term test of 10 MIL thickness (volts/mil)
- PTFE Heat Shrink tubing is available in stock packaging of 4-ft. straight lengths
- When ordering coiled tubing in colors, the color code is always followed by TC; when ordering cut lengths, the color code is followed by CC
i.e. HS2TFI7/8-2TC
i.e. HS2TFI7/8-0CC48.000

Order Information

Example: HS4TFI5/8-NC48.000

HS4TFI5/8-NC48.000 – Heat Shrink
HS4TFI5/8-NC48.000 – Shrink Ratio (4:1)
HS4TFI5/8-NC48.000 – PTFE
HS4TFI5/8-NC48.000 – Wall Type (Industrial Wall)
HS4TFI5/8-NC48.000 – Heat Shrink Size in inches (5/8")
HS4TFI5/8-NC48.000 – Natural
HS4TFI5/8-NC48.000 – Bulk Tubing
HS4TFI5/8-NC48.000 – Package Quantity in inches (48')

Order Information

Example: HS2TFS15-4TC48.000

HS2TFS15-4TC48.000 – Heat Shrink
HS2TFS15-4TC48.000 – Shrink Ratio (2:1)
HS2TFS15-4TC48.000 – PTFE
HS2TFS15-4TC48.000 – Wall Type (Standard Wall)
HS2TFS15-4TC48.000 – Heat Shrink Size in AWG (AWG15)
HS2TFS15-4TC48.000 – Red
HS2TFS15-4TC48.000 – Bulk Tubing
HS2TFS15-4TC48.000 – Solid Color
HS2TFS15-4TC48.000 – Package Quantity in inches (48')

Colors

- ○ Standard is natural
- Colors available as custom run

Color Code			Color Code		
○	N	Natural	●	5	Green
●	0	Black	●	6	Blue
●	1	Brown	●	7	Violet
●	2	Red	●	8	Gray
●	3	Orange	○	9	White
●	4	Yellow			



WARNING

This product can expose you to chemicals including Tetrafluoroethylene, which is known to the State of California to cause cancer. For more information go to www.P65Warnings.ca.gov.

PTFE Heat Shrinkable Tubing

Series 2:1 Fractional: HS2TFS, HS2TFT, HS2TFL, HS2TFI

Series HS2TFS, HS2TFT, HS2TFL, HS2TFI - 2:1 PTFE Fractional Heat Shrink Tubing

Part Number	Mil Spec Part Number	Order Size	Minimum Expanded I.D.		Maximum Recovered I.D.		Nominal Recovered Wall		Weight	
			inch	mm	inch	mm	inch	mm	lb/ft	kg/mtr
HS2TFS1/8	-	1/8	0.215	5.5	0.130	3.3	0.020 ± 0.004	0.51 ± 0.10	0.0085	0.0126
HS2TFS1/4	M23053/12-222-C	1/4	0.410	10.4	0.260	4.9	0.020 ± 0.004	0.51 ± 0.10	0.0158	0.0235
HS2TFS5/16	M23053/12-225-C	5/16	0.470	11.9	0.329	6.5	0.020 ± 0.004	0.51 ± 0.10	0.0190	0.0283
HS2TFS3/8	M23053/12-228-C	3/8	0.560	14.2	0.399	8.1	0.025 ± 0.006	0.64 ± 0.15	0.0301	0.0448
HS2TFS7/16	M23053/12-229-C	7/16	0.655	16.6	0.462	9.7	0.025 ± 0.006	0.64 ± 0.15	0.0332	0.0494
HS2TFS1/2	M23053/12-230-C	1/2	0.750	19.1	0.524	11.4	0.025 ± 0.006	0.64 ± 0.15	0.0377	0.0561
HS2TFS5/8	M23053/12-231-C	5/8	0.930	23.6	0.655	13.0	0.030 ± 0.006	0.76 ± 0.15	0.0605	0.0900
HS2TFS3/4	M23053/12-232-C	3/4	1.125	28.6	0.786	14.5	0.035 ± 0.008	0.89 ± 0.20	0.0795	0.1183
HS2TFS7/8	M23053/12-233-C	7/8	1.130	28.7	0.911	16.2	0.035 ± 0.008	0.89 ± 0.20	0.0921	0.1370
HS2TFS1.00	M23053/12-234-C	1	1.500	38.1	1.034	26.3	0.035 ± 0.008	0.89 ± 0.20	0.1040	0.1548
HS2TFT1/8	M23053/12-319-C	1/8	0.215	5.5	0.130	3.3	0.015 ± 0.003	0.38 ± 0.08	0.0061	0.0091
HS2TFT1/4	M23053/12-326-C	1/4	0.410	10.4	0.260	6.6	0.015 ± 0.004	0.38 ± 0.10	0.0119	0.0177
HS2TFT5/16	M23053/12-329-C	5/16	0.470	11.9	0.329	8.4	0.015 ± 0.004	0.38 ± 0.10	0.0148	0.0220
HS2TFT3/8	-	3/8	0.560	14.2	0.399	10.1	0.015 ± 0.004	0.38 ± 0.10	0.0176	0.0262
HS2TFT7/16	-	7/16	0.655	16.6	0.462	11.7	0.018 ± 0.004	0.46 ± 0.10	0.0240	0.0357
HS2TFT1/2	-	1/2	0.750	19.1	0.524	13.3	0.018 ± 0.004	0.46 ± 0.10	0.0278	0.0414
HS2TFT5/8	-	5/8	0.930	23.6	0.655	16.6	0.020 ± 0.004	0.51 ± 0.10	0.0375	0.0558
HS2TFT3/4	-	3/4	1.125	28.6	0.786	20.0	0.025 ± 0.004	0.64 ± 0.10	0.0746	0.1110
HS2TFT7/8	-	7/8	1.130	28.7	0.911	23.1	0.025 ± 0.004	0.64 ± 0.10	0.0795	0.1183
HS2TFT1.00	-	1	1.500	38.1	1.034	26.3	0.025 ± 0.004	0.64 ± 0.10	0.0904	0.1345
HS2TFL1/8	M23053/12-415	1/8	0.215	5.5	0.130	3.3	0.008 ± 0.002	0.20 ± 0.05	0.014	0.021
HS2TFL1/4	M23053/12-422	1/4	0.410	10.4	0.260	6.6	0.010 ± 0.003	0.25 ± 0.08	0.020	0.030
HS2TFL5/16	M23053/12-425	5/16	0.470	11.9	0.329	8.4	0.012 ± 0.003	0.31 ± 0.08	0.026	0.039
HS2TFI1/8	-	1/8	0.166	4.2	0.130	3.3	0.030 ± 0.005	0.76 ± 0.13	0.0114	0.0170
HS2TFI3/16	M23053/12-102-C	3/16	0.250	6.4	0.193	4.9	0.030 ± 0.005	0.76 ± 0.13	0.0191	0.0284
HS2TFI1/4	M23053/12-103-C	1/4	0.333	8.4	0.257	6.5	0.030 ± 0.005	0.76 ± 0.13	0.0246	0.0366
HS2TFI5/16	M23053/12-104-C	5/16	0.415	10.5	0.320	8.1	0.030 ± 0.005	0.76 ± 0.13		0.0000
HS2TFI3/8	M23053/12-105-C	3/8	0.498	12.6	0.383	9.7	0.030 ± 0.005	0.76 ± 0.13	0.0342	0.0509
HS2TFI7/16	M23053/12-106-C	7/16	0.580	14.7	0.448	11.4	0.030 ± 0.006	0.76 ± 0.15	0.0411	0.0612
HS2TFI1/2	M23053/12-107-C	1/2	0.666	16.9	0.510	13.0	0.030 ± 0.006	0.76 ± 0.15	0.0461	0.0686
HS2TFI9/16	M23053/12-108-C	1/2	0.748	19.0	0.572	14.5	0.030 ± 0.006	0.76 ± 0.15	0.0519	0.0772
HS2TFI5/8	M23053/12-109-C	5/8	0.830	21.1	0.637	16.2	0.030 ± 0.006	0.76 ± 0.15	0.0476	0.0708
HS2TFI11/16	M23053/12-110-C	11/16	0.915	23.2	0.700	17.8	0.032 ± 0.006	0.81 ± 0.15	0.6300	0.9374
HS2TFI3/4	-	3/4	1.000	25.4	0.764	19.4	0.040 ± 0.007	1.02 ± 0.18		0.0000
HS2TFI7/8	-	7/8	1.170	29.7	0.891	22.6	0.045 ± 0.007	1.14 ± 0.18		0.0000
HS2TFI1.00	-	1	1.330	33.8	1.020	25.9	0.050 ± 0.008	1.27 ± 0.20		0.0000

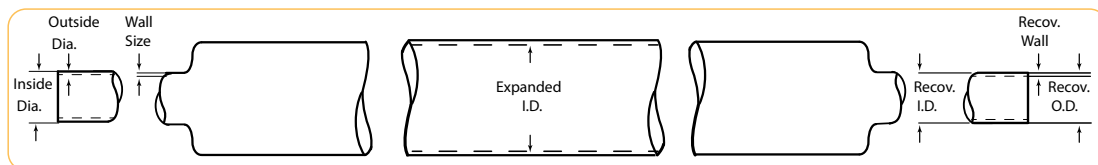

WARNING

This product can expose you to chemicals including Tetrafluoroethylene, which is known to the State of California to cause cancer. For more information go to www.P65Warnings.ca.gov.

PTFE Heat Shrinkable Tubing

Series HS2TFS AWG 2:1

Series HS2TFS - AWG 2:1 Standard Wall Heat Shrink Tubing

Part Number	Mil Spec Part Number	Minimum Expanded I.D.		Maximum Recovered I.D.		Nominal Recovered Wall		Weight	
		inch	mm	inch	mm	inch	mm	lb/ft	kg/mtr
HS2TFS24	M23053/12-201-C	0.050	1.3	0.027	0.7	0.012 ± 0.002	0.31 ± 0.05	0.0011	0.0016
HS2TFS22	M23053/12-202-C	0.055	1.4	0.032	0.8	0.012 ± 0.002	0.31 ± 0.05	0.0013	0.0019
HS2TFS20	M23053/12-203-C	0.060	1.5	0.039	1.0	0.016 ± 0.003	0.41 ± 0.08	0.0022	0.0033
HS2TFS19	M23053/12-204-C	0.065	1.7	0.043	1.1	0.016 ± 0.003	0.41 ± 0.08	0.0024	0.0036
HS2TFS18	M23053/12-205-C	0.076	1.9	0.049	1.3	0.016 ± 0.003	0.41 ± 0.08	0.0028	0.0042
HS2TFS17	M23053/12-206-C	0.085	2.2	0.054	1.4	0.016 ± 0.003	0.41 ± 0.08	0.0029	0.0043
HS2TFS16	-	0.093	2.4	0.061	1.6	0.016 ± 0.003	0.41 ± 0.08	0.0033	0.0049
HS2TFS15	M23053/12-207-C	0.110	2.8	0.067	1.7	0.016 ± 0.003	0.41 ± 0.08	0.0035	0.0052
HS2TFS14	M23053/12-208-C	0.120	3.1	0.072	1.8	0.016 ± 0.003	0.41 ± 0.08	0.0038	0.0057
HS2TFS13	M23053/12-210-C	0.140	3.6	0.080	2.0	0.016 ± 0.003	0.41 ± 0.08	0.0041	0.0061
HS2TFS12	M23053/12-211-C	0.150	3.8	0.089	2.3	0.016 ± 0.003	0.41 ± 0.08	0.0044	0.0065
HS2TFS11	M23053/12-212-C	0.170	4.3	0.101	2.6	0.016 ± 0.003	0.41 ± 0.08	0.0050	0.0074
HS2TFS10	M23053/12-213-C	0.191	4.9	0.112	2.8	0.016 ± 0.003	0.41 ± 0.08	0.0055	0.0082
HS2TFS09	M23053/12-214-C	0.205	5.2	0.124	3.2	0.020 ± 0.004	0.51 ± 0.10	0.0075	0.0112
HS2TFS08	M23053/12-216-C	0.240	6.1	0.141	3.6	0.020 ± 0.004	0.51 ± 0.10	0.0099	0.0147
HS2TFS07	M23053/12-217-C	0.270	6.9	0.158	4.0	0.020 ± 0.004	0.51 ± 0.10	0.0097	0.0144
HS2TFS06	M23053/12-218-C	0.302	7.7	0.178	4.5	0.020 ± 0.004	0.51 ± 0.10	0.0107	0.0159
HS2TFS05	M23053/12-219-C	0.320	8.1	0.198	5.0	0.020 ± 0.004	0.51 ± 0.10	0.0133	0.0198
HS2TFS04	M23053/12-220-C	0.370	9.4	0.224	5.7	0.020 ± 0.004	0.51 ± 0.10	0.0114	0.0170
HS2TFS03	M23053/12-221-C	0.390	9.9	0.249	6.3	0.020 ± 0.004	0.51 ± 0.10	0.0150	0.0223
HS2TFS02	M23053/12-223-C	0.430	10.9	0.278	7.1	0.020 ± 0.004	0.51 ± 0.10	0.0167	0.0248
HS2TFS01	M23053/12-224-C	0.450	11.4	0.311	7.9	0.020 ± 0.004	0.51 ± 0.10	0.0186	0.0277
HS2TFS00	M23053/12-226-C	0.470	11.9	0.347	8.8	0.020 ± 0.004	0.51 ± 0.10	0.0203	0.0302

*Dielectric Strength: > 800 v/m, per ASTM D 149 short term test of 10 MIL thickness (volts/mil)

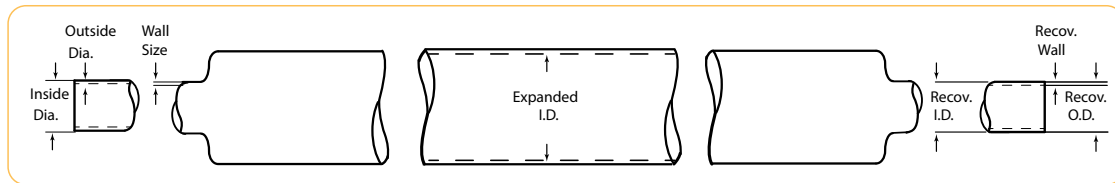

Colors

- Standard is natural
- Colors available as custom run

Color Code			Color Code		
○	N	Natural	●	5	Green
●	0	Black	●	6	Blue
●	1	Brown	●	7	Violet
●	2	Red	●	8	Gray
●	3	Orange	○	9	White
●	4	Yellow			



WARNING

This product can expose you to chemicals including Tetrafluoroethylene, which is known to the State of California to cause cancer. For more information go to www.P65Warnings.ca.gov.

PTFE Heat Shrinkable Tubing

Series HS2TFT AWG 2:1

Series HS2TFT - AWG 2:1 Thin Wall Heat Shrink Tubing

Part Number	Mil Spec Part Number	Order Size AWG	Minimum Expanded I.D.		Maximum Recovered I.D.		Nominal Recovered Wall		Weight	
			inch	mm	inch	mm	inch	mm	lb/ft	kg/mtr
HS2TFT24	M23053/12-304-C	24	0.050	1.3	0.027	0.7	0.010 ± 0.002	0.25 ± 0.08	0.0009	0.0013
HS2TFT22	M23053/12-305-C	22	0.055	1.4	0.032	0.8	0.012 ± 0.003	0.31 ± 0.08	0.0014	0.0021
HS2TFT20	M23053/12-306-C	20	0.060	1.5	0.039	1.0	0.012 ± 0.003	0.31 ± 0.08	0.0015	0.0022
HS2TFT19	M23053/12-307-C	19	0.065	1.7	0.043	1.1	0.012 ± 0.003	0.31 ± 0.08	0.0018	0.0027
HS2TFT18	M23053/12-308-C	18	0.076	1.9	0.049	1.3	0.012 ± 0.003	0.31 ± 0.08	0.0019	0.0028
HS2TFT17	M23053/12-309-C	17	0.085	2.2	0.054	1.4	0.012 ± 0.003	0.31 ± 0.08	0.0021	0.0031
HS2TFT16	M23053/12-310-C	16	0.093	2.4	0.061	1.6	0.012 ± 0.003	0.31 ± 0.08	0.0024	0.0036
HS2TFT15	M23053/12-311-C	15	0.110	2.8	0.067	1.7	0.012 ± 0.003	0.31 ± 0.08	0.0025	0.0037
HS2TFT14	M23053/12-312-C	14	0.120	3.1	0.072	1.8	0.012 ± 0.003	0.31 ± 0.08	0.0028	0.0042
HS2TFT13	M23053/12-313-C	13	0.140	3.6	0.080	2.0	0.012 ± 0.003	0.31 ± 0.08	0.0030	0.0045
HS2TFT12	M23053/12-314-C	12	0.150	3.8	0.089	2.3	0.012 ± 0.003	0.31 ± 0.08	0.0032	0.0048
HS2TFT11	M23053/12-316-C	11	0.170	4.3	0.101	2.6	0.012 ± 0.003	0.31 ± 0.08	0.0036	0.0054
HS2TFT10	M23053/12-317-C	10	0.191	4.9	0.112	2.8	0.012 ± 0.003	0.31 ± 0.08	0.0040	0.0060
HS2TFT09	M23053/12-318-C	9	0.205	5.2	0.124	3.2	0.015 ± 0.004	0.38 ± 0.10	0.0056	0.0083
HS2TFT08	M23053/12-320-C	8	0.240	6.1	0.141	3.6	0.015 ± 0.004	0.38 ± 0.10	0.0063	0.0094
HS2TFT07	M23053/12-321-C	7	0.270	6.9	0.158	4.0	0.015 ± 0.004	0.38 ± 0.10	0.0071	0.0106
HS2TFT06	M23053/12-322-C	6	0.302	7.7	0.178	4.5	0.015 ± 0.004	0.38 ± 0.10	0.0080	0.0119
HS2TFT05	M23053/12-323-C	5	0.320	8.1	0.198	5.0	0.015 ± 0.004	0.38 ± 0.10	0.0090	0.0134
HS2TFT04	M23053/12-324-C	4	0.370	9.4	0.224	5.7	0.015 ± 0.004	0.38 ± 0.10	0.0097	0.0144
HS2TFT03	M23053/12-325-C	3	0.390	9.9	0.249	6.3	0.015 ± 0.004	0.38 ± 0.10	0.0108	0.0161
HS2TFT02	M23053/12-327-C	2	0.430	10.9	0.278	7.1	0.015 ± 0.004	0.38 ± 0.10	0.0125	0.0186
HS2TFT01	M23053/12-328-C	1	0.450	11.4	0.311	7.9	0.015 ± 0.004	0.38 ± 0.10	0.0123	0.0183
HS2TFT00	M23053/12-330-C	0	0.470	11.9	0.347	8.8	0.015 ± 0.004	0.38 ± 0.10	0.0148	0.0220

*Dielectric Strength: > 800 v/m, per ASTM D 149 short term test of 10 MIL thickness (volts/mil)

Colors

- Standard is natural
- Colors available as custom run

Color Code			Color Code		
○	N	Natural	●	5	Green
●	0	Black	●	6	Blue
●	1	Brown	●	7	Violet
●	2	Red	●	8	Gray
●	3	Orange	○	9	White
●	4	Yellow			



WARNING

This product can expose you to chemicals including Tetrafluoroethylene, which is known to the State of California to cause cancer. For more information go to www.P65Warnings.ca.gov.

PTFE Heat Shrinkable Tubing

Series HS2TFL AWG 2:1

Series HS2TFL - AWG 2:1 Light Wall Heat Shrink Tubing

Part Number	Mil Spec Part Number	Order Size AWG	Minimum Expanded I.D.		Maximum Recovered I.D.		Nominal Recovered Wall		Weight	
			inch	mm	inch	mm	inch	mm	lb/ft	kg/mtr
HS2TFL24	-	24	0.050	1.3	0.025	0.6	0.006 ± 0.002	0.15 ± 0.05	0.0005	0.0007
HS2TFL22	-	22	0.055	1.4	0.031	0.8	0.006 ± 0.002	0.15 ± 0.05	0.0006	0.0009
HS2TFL20	-	20	0.060	1.5	0.038	1.0	0.006 ± 0.002	0.15 ± 0.05	0.0006	0.0009
HS2TFL19	-	19	0.065	1.7	0.043	1.1	0.006 ± 0.002	0.15 ± 0.05	0.0007	0.0010
HS2TFL18	-	18	0.076	1.9	0.046	1.2	0.006 ± 0.002	0.15 ± 0.05	0.0008	0.0012
HS2TFL17	-	17	0.085	2.2	0.054	1.4	0.006 ± 0.002	0.15 ± 0.05	0.0009	0.0013
HS2TFL16	-	16	0.093	2.4	0.057	1.5	0.006 ± 0.002	0.15 ± 0.05	0.0011	0.0016
HS2TFL15	-	15	0.110	2.8	0.063	1.6	0.006 ± 0.002	0.15 ± 0.05	0.0011	0.0016
HS2TFL14	-	14	0.120	3.1	0.072	1.8	0.008 ± 0.002	0.20 ± 0.05	0.0017	0.0025
HS2TFL13	-	13	0.140	3.6	0.080	2.0	0.008 ± 0.002	0.20 ± 0.05	0.0018	0.0027
HS2TFL12	-	12	0.150	3.8	0.089	2.3	0.008 ± 0.002	0.20 ± 0.05	0.0020	0.0030
HS2TFL11	-	11	0.170	4.3	0.099	2.5	0.008 ± 0.002	0.20 ± 0.05	0.0023	0.0034
HS2TFL10	M23053/12-413	10	0.191	4.9	0.110	2.8	0.008 ± 0.002	0.20 ± 0.05	0.0026	0.0039
HS2TFL09	M23053/12-414	9	0.205	5.2	0.122	3.1	0.008 ± 0.002	0.20 ± 0.05	0.0026	0.0039
HS2TFL08	M23053/12-416	8	0.240	6.1	0.139	3.5	0.008 ± 0.002	0.20 ± 0.05	0.0032	0.0048
HS2TFL07	M23053/12-417	7	0.270	6.9	0.154	3.9	0.008 ± 0.002	0.20 ± 0.05	0.0037	0.0055
HS2TFL06	M23053/12-418	6	0.302	7.7	0.172	4.4	0.010 ± 0.003	0.25 ± 0.08	0.0049	0.0073
HS2TFL05	M23053/12-419	5	0.320	8.1	0.192	4.9	0.010 ± 0.003	0.25 ± 0.08	0.0057	0.0085
HS2TFL04	M23053/12-420	4	0.370	9.4	0.214	5.4	0.010 ± 0.003	0.25 ± 0.08	0.0063	0.0094
HS2TFL03	M23053/12-421	3	0.390	9.9	0.241	6.1	0.010 ± 0.003	0.25 ± 0.08	0.0068	0.0101
HS2TFL02	M23053/12-423	2	0.430	10.9	0.270	6.9	0.010 ± 0.003	0.25 ± 0.08	0.0077	0.0115
HS2TFL01	M23053/12-424	1	0.450	11.4	0.301	7.7	0.010 ± 0.003	0.25 ± 0.08	0.0085	0.0126
HS2TFL00	M23053/12-426	0	0.470	11.9	0.347	8.8	0.012 ± 0.003	0.31 ± 0.08	0.0118	0.0176

*Dielectric Strength: > 800 v/m, per ASTM D 149 short term test of 10 MIL thickness (volts/mil)

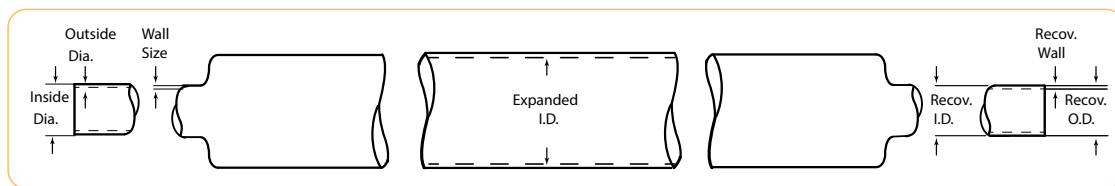

Colors

- Standard is natural
- Colors available as custom run

Color Code			Color Code		
○	N	Natural	●	5	Green
●	0	Black	●	6	Blue
●	1	Brown	●	7	Violet
●	2	Red	●	8	Gray
●	3	Orange	○	9	White
●	4	Yellow			



WARNING

This product can expose you to chemicals including Tetrafluoroethylene, which is known to the State of California to cause cancer. For more information go to www.P65Warnings.ca.gov.

PTFE Heat Shrinkable Tubing

Series HS24TFI 4:1

Series HS4TFI - PTFE 4:1 Industrial Wall Heat Shrink Tubing

Part Number		Order Size	Minimum Expanded I.D.		Maximum Recovered I.D.		Nominal Recovered Wall		Weight	
			inch	mm	inch	mm	inch	mm	lb/ft	kg/mtr
HS4TFI5/64	M23053/12-501	5/64	0.078	2.0	0.025	0.6	0.009 ± 0.002	0.23 ± 0.05	0.0008	0.0012
HS4TFI1/8	M23053/12-502	1/8	0.125	3.2	0.037	0.9	0.012 ± 0.002	0.31 ± 0.05	0.0014	0.0021
HS4TFI3/16	M23053/12-503	3/16	0.187	4.8	0.050	1.3	0.012 ± 0.002	0.31 ± 0.05	0.0020	0.0030
HS4TFI1/4	M23053/12-504	1/4	0.250	6.4	0.063	1.6	0.012 ± 0.002	0.31 ± 0.05	0.0028	0.0042
HS4TFI5/16	M23053/12-505	5/16	0.312	7.9	0.078	2.0	0.012 ± 0.002	0.31 ± 0.05	0.0030	0.0045
HS4TFI3/8	M23053/12-506	3/8	0.375	9.5	0.096	2.4	0.012 ± 0.002	0.31 ± 0.05	0.0035	0.0052
HS4TFI7/16	M23053/12-507	7/16	0.438	11.1	0.112	2.8	0.012 ± 0.002	0.31 ± 0.05	0.0048	0.0071
HS4TFI1/2	M23053/12-508	1/2	0.500	12.7	0.144	3.7	0.015 ± 0.004	0.38 ± 0.10	0.0075	0.0112
HS4TFI5/8	M23053/12-510	5/8	0.625	15.9	0.178	4.5	0.015 ± 0.004	0.38 ± 0.10	0.0092	0.0137
HS4TFI3/4	M23053/12-512	3/4	0.750	19.1	0.224	5.7	0.015 ± 0.004	0.38 ± 0.10	0.0113	0.0168
HS4TFI7/8	M23053/12-513	7/8	0.875	22.2	0.244	6.2	0.015 ± 0.004	0.38 ± 0.10	0.0116	0.0173
HS4TFI1.00	M23053/12-514	1	1.000	25.4	0.278	7.1	0.015 ± 0.004	0.38 ± 0.10	0.0140	0.0208
HS4TFI1.25	M23053/12-515	1-1/4	1.250	31.8	0.347	8.8	0.015 ± 0.004	0.38 ± 0.10	0.0174	0.0259

*Dielectric Strength: >800 v/m, per ASTM D 149 short term test of 10 MIL thickness (volts/mil)

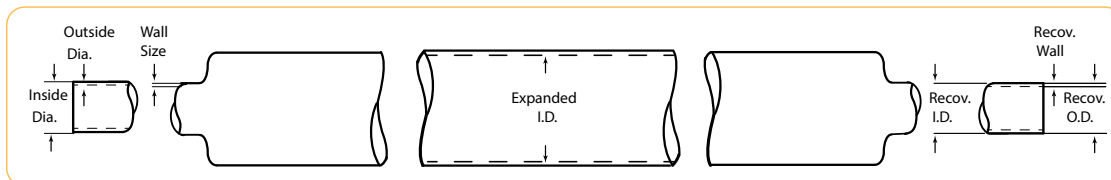

Colors

- Standard is natural
- Colors available as custom run

Color Code			Color Code		
○	N	Natural	●	5	Green
●	0	Black	●	6	Blue
●	1	Brown	●	7	Violet
●	2	Red	●	8	Gray
●	3	Orange	○	9	White
●	4	Yellow			



WARNING

This product can expose you to chemicals including Tetrafluoroethylene, which is known to the State of California to cause cancer. For more information go to www.P65Warnings.ca.gov.

PTFE Convoluted Tubing

Series CV01, CVL, CVH

High temperature electrical insulation
for harnessing wires and cables.



Features

- Chemically inert
- Low coefficient of friction
- Very flexible
- Self extinguishing
- Non-wetting
- Low Profile - Larger inside diameter for increased flow
- Heavy Wall - Reinforces the strength of the tube allowing for braiding or covering, flanging or flaring; handles higher vacuum

Notes

- Working Temperature: °F (-73°C) to 500°F (260°C)
- Standard cuffs are sized on the inside diameter
- Wire wrap reinforcement can be added for increased pressure applications or when a tighter bend radius is needed
- ** Minimum 36" length

Fittings

Parker Fittings available from:
Fluid System Connectors Division
Otsego, MI

(269) 692-6555
(269) 692-6634 FAX
parker.com/fsc

For approved fittings and/or suggested use of tube supports, reference Tube/Fitting Compatibility Chart (pg. B-8/B-9) or contact Parker Fluid Systems Connectors Division

Compliance

- AMS 3653
- 21 CFR 177.1550 Compliant
- USP Class VI Compliant
- UL94V-0

Colors

- ○ Standard is natural
- Colors available as custom run

Color Code			Color Code		
○	N	Natural	●	5	Green
●	0	Black	●	6	Blue
●	1	Brown	●	7	Violet
●	2	Red	●	8	Gray
●	3	Orange	○	9	White
●	4	Yellow			

Standard Cuffs
are sized on the I.D.

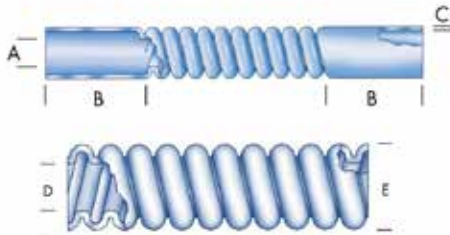

Order Information

Example: CV01-1/8-NT

CV01-1/8-NT – Convoluted

CV01-1/8-NT – PTFE

CV01-1/8-NT – Tube O.D. in inches (1/8")

CV01-1/8-NT – Natural

CV01-1/8-NT – Bulk Tubing "T" is bulk (for cuffed tubing, remove "T" and add length, ie. CV01-1/8-NT-N1200 = 1" Convo, natural, cut 12" long)



WARNING

This product can expose you to chemicals including Tetrafluoroethylene, which is known to the State of California to cause cancer. For more information go to www.P65Warnings.ca.gov.

PTFE Convoluted Tubing

Series CV01, CVL, CVH

Series CV01 - Standard Convoluted Tubing

Part Number	Order Size	Standard Cuff I.D. "A"		Standard Cuff Length "B"		Wall Thickness "C"		Minimum Inside Diameter "D"		Maximum Inside Diameter "D"		Maximum Outside Diameter "E"		**Minimum Bend Radius		Weight	
		inch	mm	inch	mm	inch	mm	inch	mm	inch	mm	inch	mm	inch	mm	lb/ft	kg/mtr
CV01-1/8-NT	CONV-2	1/8	3.18	3/4	19.1	0.010	0.25	0.130	3.3	0.140	3.6	0.235	5.9	3/8	9.5	0.007	0.008
CV01-1/4-NT	CONV-4	1/4	6.35	3/4	19.1	0.015	0.38	0.181	4.6	0.188	4.8	0.320	8.1	1/2	12.7	0.014	0.016
CV01-5/16-NT	CONV-5	5/16	7.94	1	25.4	0.020	0.51	0.273	6.9	0.281	7.1	0.414	10.5	3/4	19.1	0.024	0.028
CV01-3/8-NT	CONV-6	3/8	9.53	1	25.4	0.020	0.51	0.303	7.7	0.312	7.9	0.450	11.4	1-3/4	44.4	0.029	0.034
CV01-1/2-NT	CONV-8	1/2	12.7	1	25.4	0.020	0.51	0.425	10.8	0.437	11.1	0.590	15.0	1-1/4	31.2	0.045	0.042
CV01-5/8-NT	CONV-10	5/8	15.9	1-1/4	31.8	0.025	0.64	0.485	12.3	0.500	12.7	0.660	16.8	1-1/2	38.1	0.058	0.054
CV01-3/4-NT	CONV-12	3/4	19.1	1-1/2	38.1	0.023	0.58	0.608	15.4	0.625	15.9	0.780	19.8	1-3/4	44.4	0.071	0.066
CV01-1.00-NT	CONV-16	1	25.4	2	50.8	0.030	0.76	0.849	21.6	0.875	22.2	1.100	27.9	2-1/4	57.2	0.126	0.118
CV01-1.25-NT	CONV-20	1-1/4	31.8	2-1/2	63.5	0.035	0.89	1.150	29.2	1.190	30.2	1.560	39.6	2-3/4	69.9	0.207	0.193
CV01-1.50-NT	CONV-24	1-1/2	38.1	2-1/2	63.5	0.040	1.02	1.410	35.8	1.490	37.8	1.910	48.5	3	76.2	0.273	0.254
CV01-2.00-NT	CONV-32	2	50.8	2-1/2	63.5	0.043	1.09	1.955	49.7	1.985	50.4	2.450	62.2	4-1/4	107.9	0.516	0.384
CV01-2.50-NT	CONV-40	2-1/2	63.5	2-1/2	63.5	0.062	1.57	2.460	62.5	2.540	64.5	3.210	81.6	5	127.0	0.905	0.674
CV01-3.00-NT	CONV-48	3	76.2	2-1/2	63.5	0.070	1.78	2.940	74.7	3.060	77.7	3.750	95.3	7	177.8	1.123	0.836
CV01-4.00-NT	CONV-64	4	101.6	2-1/2	63.5	0.070	1.78	3.940	100.1	4.060	103.1	4.750	120.6	9	228.6	1.559	1.160

** Minimum 36" length

Series CVL - Low Profile Convoluted Tubing

Part Number	Order Size	Minimum Inside Diameter	Maximum Inside Diameter	Maximum Outside Diameter	Wall Thickness	**Minimum Bend Radius	Weight						
		inch	mm	inch	mm	inch	kg/mtr						
CVL01-3/8-NT	3/8	0.394	10.0	0.410	10.3	0.560	14.2	0.023	0.58	1/2	13	0.040	0.046
CVL01-1/2-NT	1/2	0.490	12.5	0.510	13.0	0.700	17.8	0.025	0.64	3/4	19	0.066	0.061
CVL01-3/4-NT	3/4	0.740	18.8	0.760	19.3	0.980	24.9	0.035	0.89	1.88	48	0.142	0.132
CVL01-1.00-NT	1	0.990	25.1	1.010	25.7	1.260	32.0	0.035	0.89	2-1/4	57	0.185	0.172
CVL01-1.25-NT	1-1/4	1.210	30.7	1.250	31.8	1.539	39.1	0.035	0.89	3	76	0.213	0.198
CVL01-1.50-NT	1-1/2	1.520	38.6	1.540	39.1	1.870	47.5	0.044	1.12	3-1/2	89	0.303	0.282
CVL01-1.75-NT	1-3/4	1.690	42.9	1.750	44.5	2.100	53.3	0.040	1.02	4-1/4	108	***	***
CVL01-2.00-NT	2	2.010	51.1	2.030	51.6	2.370	60.2	0.043	1.09	4-3/4	121	0.493	0.367

** Minimum 36" length ***Contact Division

Series CVH - Heavy Wall Convoluted Tubing

Part Number	Order Size	Minimum Inside Diameter	Maximum Inside Diameter	Maximum Outside Diameter	Wall Thickness	**Minimum Bend Radius	Weight						
		inch	mm	inch	mm	inch	kg/mtr						
CVH01-1/4-NT	1/4	0.257	6.5	0.265	6.7	0.415	10.5	0.025	0.64	3/4	19	***	***
CVH01-3/8-NT	3/8	0.335	8.5	0.345	8.8	0.510	13.0	0.025	0.64	1	25	0.039	0.044
CVH01-1/2-NT	1/2	0.454	11.5	0.466	11.8	0.700	17.8	0.035	0.89	1-1/2	38	0.088	0.082
CVH01-3/4-NT	3/4	0.683	17.4	0.701	17.8	1.010	25.7	0.050	1.27	1.88	48	0.083	0.077
CVH01-1.00-NT	1	0.841	21.4	0.859	21.8	1.210	30.7	0.053	1.35	2-1/2	64	0.265	0.247
CVH01-1.25-NT	1-1/4	1.125	28.6	1.145	29.1	1.610	40.9	0.062	1.57	3.13	79	0.381	0.354
CVH01-1.50-NT	1-1/2	1.420	36.1	1.480	37.6	1.880	47.8	0.062	1.57	3-3/5	95	0.454	0.422
CVH01-1.75-NT	1-3/4	1.540	39.1	1.600	40.6	2.100	53.3	0.062	1.57	4-1/4	114	***	***
CVH01-2.00-NT	2	1.770	45.0	1.830	46.5	2.432	61.8	0.062	1.57	4-3/4	120	0.729	0.542
CVH01-2.50-NT	2-1/2	2.460	62.5	2.540	64.5	3.210	81.5	0.062	1.57	5	127	***	***
CVH01-3.00-NT	3	2.940	74.7	3.060	77.7	3.750	95.3	0.062	1.57	7	178	***	***
CVH01-4.00-NT	4	3.900	100.0	4.060	103.0	4.750	121.0	0.070	1.77	9	229	***	***

** Minimum 36" length ***Contact Division



WARNING

This product can expose you to chemicals including Tetrafluoroethylene, which is known to the State of California to cause cancer. For more information go to www.P65Warnings.ca.gov.

PTFE Convoluted Tubing

Series 81914/1, 81914/2

Mil spec convoluted for the Military and Defense wire harnessing industries.



Features

- Chemically inert
- Low coefficient of friction
- Very flexible
- Self extinguishing
- Non-wetting

Compliance

- AMS 3653
- Dimensionally compliant to AS81914/1 and AS81914/2
- 21 CFR 177.1550 Compliant
- UL94V-0

Notes

- Working Temperature: °F [-73°C] to 500°F (260°C)
- Tubing is provided in black without cuffs direct from inventory
- Stock packaging is random coils
- Also available in close convolution 81914/2

Colors

- ○ Standard is natural
- Colors available as custom run

Color Code			Color Code		
○	N	Natural	●	5	Green
●	0	Black	●	6	Blue
●	1	Brown	●	7	Violet
●	2	Red	●	8	Gray
●	3	Orange	○	9	White
●	4	Yellow			

Fittings

Parker Fittings available from:
Fluid System Connectors Division
Otsego, MI

(269) 692-6555
(269) 692-6634 FAX
parker.com/fsc

For approved fittings and/or suggested use of tube supports, reference Tube/Fitting Compatibility Chart (pg. B-8/B-9) or contact Parker Fluid Systems Connectors Division

Order Information

Example: 81914/1-1010-0TC

81914/1-1010-0TC – Mil Spec Convoluted

81914/1-1010-0TC – PTFE

81914/1-1010-0TC – Helical Convolutions

81914/1-1010-0TC – Size 10 = 1"

81914/1-1010-0TC – Color 0 = Black

81914/1-1010-0TC – Bulk Tubing "T" is bulk



WARNING

This product can expose you to chemicals including Tetrafluoroethylene, which is known to the State of California to cause cancer. For more information go to www.P65Warnings.ca.gov.

PTFE Convoluted Tubing

Series 81914/1, 81914/2

Series 81914/1 - Convoluted Tubing

Part Number	Order Size	Maximum Inside Diameter		Minimum Inside Diameter		Maximum Outside Diameter		Maximum Wall Thickness		*Minimum Bend Radius		Pitch	Weight	
		inch	mm	inch	mm	inch	mm	inch	mm	inch	mm		lb/ft	kg/mtr
81914/1001-OTC	-1	0.188	4.78	0.181	4.6	0.320	8.13	0.023	0.584	1/2	13	8	0.020	0.018
81914/1002-OTC	-2	0.281	7.14	0.273	6.93	0.414	10.5	0.027	0.686	3/4	19	7.5	0.028	0.026
81914/1003-OTC	-3	0.312	7.93	0.303	7.7	0.450	11.4	0.027	0.686	7/8	22	7.5	0.029	0.027
81914/1004-OTC	-4	0.375	9.53	0.364	9.25	0.530	13.5	0.029	0.737	1	25	7	0.036	0.034
81914/1005-OTC	-5	0.437	11.1	0.425	10.8	0.590	15.0	0.029	0.737	1-1/4	32	7	0.049	0.046
81914/1006-OTC	-6	0.500	12.7	0.485	12.3	0.660	16.8	0.029	0.737	1-1/2	38	7	0.055	0.051
81914/1007-OTC	-7	0.625	15.9	0.608	15.4	0.780	19.9	0.035	0.889	1-3/4	44	7	0.062	0.057
81914/1008-OTC	-8	0.750	19.1	0.730	18.5	0.975	24.8	0.035	0.889	1.88	48	6	0.100	0.093
81914/1009-OTC	-9	0.875	22.2	0.850	21.6	1.100	27.9	0.035	0.889	2-1/4	57	6	0.120	0.112
81914/1-1010-OTC	-10	1.000	25.4	0.975	24.8	1.260	32.0	0.035	0.889	2-1/2	64	4.5	0.132	0.123
81914/1-1011-OTC	-11	1.125	28.6	1.100	27.9	1.390	35.3	0.035	0.889	2-3/4	70	4.5	0.170	0.158
81914/1-1012-OTC	-12	1.250	31.8	1.210	30.7	1.539	39.1	0.035	0.889	3	76	4	0.198	0.184
81914/1-1013-OTC	-13	1.500	38.1	1.440	36.6	1.850	47.0	0.040	1.020	3-3/4	95	4	0.245	0.228
81914/1-1014-OTC	-14	1.750	44.5	1.690	42.9	2.100	53.3	0.045	1.140	4-1/4	108	4	0.289	0.269
81914/1-1015-OTC	-15	2.000	50.8	1.940	49.3	2.350	59.7	0.045	1.140	4-3/4	121	4	0.371	0.345

*PTFE convoluted tubing is provided in BLACK without cuffs directly from the factory. Black part numbers are designated with "OT". Natural part numbers are designated with "NT" after the Mil Spec number (i.e., 81914/1-1014-OT). Also available in 81914/2 (Close Convolution).

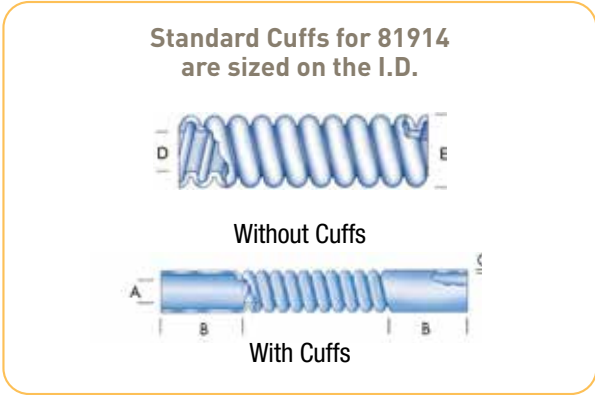

WARNING

This product can expose you to chemicals including Tetrafluoroethylene, which is known to the State of California to cause cancer. For more information go to www.P65Warnings.ca.gov.

FEP Tubing

Series 103, 203: Fractional & Metric

Translucent and chemically inert
with long continuous lengths.

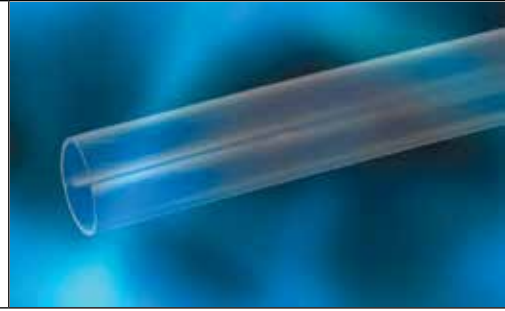

Features

- Virgin Fluorinated Ethylene Propylene resin
- Translucent
- Chemically inert
- Long continuous lengths
- Low coefficient of friction
- Self extinguishing
- Non-wetting
- Weldable

Compliance

- ASTM D2116
- 21 CFR 177.1550 Compliant
- USP Class VI Compliant
- UL94V-0

Notes

- Working Temperature: °F (-75°C) to 400°F (204°C)
- Vacuum Rating 28 @ 73°F
- Working pressure calculated using a Design Factor of 4
- Custom packaging and sizes are quoted upon request

FEP Tubing (Series 103, 203)

Maximum Working Pressure (psi)

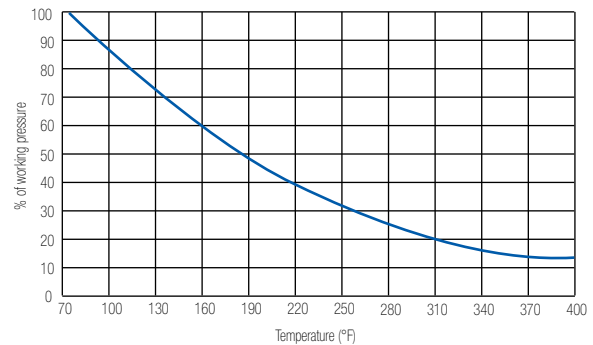

Fittings

Parker Fittings available from:
Fluid System Connectors Division
Otsego, MI

(269) 692-6555
(269) 692-6634 FAX
parker.com/fsc

For approved fittings and/or suggested use of tube supports,
reference Tube/Fitting Compatibility Chart (pg. B-8/B-9) or
contact Parker Fluid Systems Connectors Division

Order Information

Example: 103-0250031-NT-100

103-0250031-NT-100 – FEP

103-0250031-NT-100 – Tube O.D. in inches (1/4")

103-0250031-NT-100 – Tube Wall Thickness in inches (.031")

103-0250031-NT-100 – Natural

103-0250031-NT-100 – Bulk Tubing

103-0250031-NT-100 – Package Quantity in feet (100')



WARNING

This product can expose you to chemicals including Tetrafluoroethylene, which is known to the State of California to cause cancer. For more information go to www.P65Warnings.ca.gov.

FEP Tubing

Series 103

Series 103 - FEP Fractional Industrial Wall Tubing

Part Number	Order Size	Nominal O.D.				Nominal I.D.				Reference Wall Thickness		Working Pressure 73°F (23°C)		Minimum Burst Pressure		Minimum Bend Radius		Vac. Rating	Weight	
		inch	inch	tol.	mm	tol.	inch	tol.	mm	tol.	inch	mm	psi	bar	psi	bar	inch		mm	lb./ft.
103-0094031	3/32	0.094	± 0.005	2.40	± 0.127	0.031	± 0.002	0.79	± 0.051	0.031	0.79	630	43	2520	174	0.500	13	28	0.006	0.009
103-0125031	1/8	0.125	± 0.003	3.18	± 0.076	0.062	± 0.003	1.57	± 0.076	0.031	0.79	470	32	1880	130	0.375	10	28	0.009	0.013
103-0156031	5/32	0.157	± 0.005	3.99	± 0.127	0.094	± 0.005	2.39	± 0.127	0.031	0.79	360	25	1440	99	0.375	10	28	0.011	0.017
103-0188031	3/16	0.188	± 0.005	4.78	± 0.127	0.125	± 0.005	3.18	± 0.127	0.031	0.79	290	20	1160	80	0.750	19	28	0.014	0.021
103-0250031	1/4	0.250	± 0.005	6.35	± 0.127	0.188	± 0.005	4.78	± 0.127	0.031	0.79	210	14	840	58	1.750	44	28	0.020	0.030
103-0312031	5/16	0.312	± 0.005	7.92	± 0.127	0.250	± 0.005	6.35	± 0.127	0.031	0.79	160	11	640	44	2.250	57	28	0.025	0.038
103-0375031	3/8	0.375	± 0.005	9.52	± 0.127	0.312	± 0.005	7.92	± 0.127	0.031	0.79	130	9	520	36	2.750	70	28	0.031	0.047
103-0438031	7/16	0.438	± 0.005	11.13	± 0.127	0.375	± 0.005	9.52	± 0.127	0.031	0.79	110	8	440	30	4.000	102	28	0.037	0.055
103-0500031	1/2	0.500	± 0.006	12.70	± 0.152	0.438	± 0.006	11.13	± 0.152	0.031	0.79	90	6	360	25	4.000	102	28	0.043	0.063
103-0563031	9/16	0.563	± 0.006	14.30	± 0.152	0.500	± 0.006	12.70	± 0.152	0.031	0.79	80	6	320	22	5.000	127	28	0.054	0.080

Series 103 - FEP Fractional Heavy Wall Tubing

103-0188062	3/16	0.188	± 0.005	4.78	± 0.127	0.064	± 0.005	1.63	± 0.127	0.062	1.57	630	43	2520	174	0.250	6	28	0.023	0.034
103-0250040	1/4	0.250	± 0.005	6.35	± 0.127	0.170	± 0.005	4.32	± 0.127	0.040	1.02	280	19	1120	77	1.250	32	28	0.025	0.037
103-0250047	1/4	0.250	± 0.005	6.35	± 0.127	0.156	± 0.005	3.96	± 0.127	0.047	1.19	340	23	1360	94	0.750	19	28	0.028	0.042
103-0250062	1/4	0.250	± 0.005	6.35	± 0.127	0.125	± 0.005	3.18	± 0.127	0.062	1.57	470	32	1880	130	0.750	19	28	0.034	0.051
103-0312062	5/16	0.312	± 0.005	7.92	± 0.127	0.188	± 0.005	4.78	± 0.127	0.062	1.57	360	25	1440	99	1.375	35	28	0.045	0.067
103-0375062	3/8	0.375	± 0.005	9.52	± 0.127	0.250	± 0.005	6.35	± 0.127	0.062	1.57	290	20	1160	80	1.500	38	28	0.057	0.085
103-0438062	7/16	0.438	± 0.005	11.13	± 0.127	0.312	± 0.005	7.92	± 0.127	0.062	1.57	250	17	1000	69	2.625	67	28	0.068	0.101
103-0500062	1/2	0.500	± 0.005	12.70	± 0.127	0.375	± 0.005	9.53	± 0.127	0.062	1.57	210	14	840	58	2.125	54	28	0.079	0.118
103-0625062	5/8	0.625	± 0.006	15.88	± 0.152	0.500	± 0.006	12.70	± 0.152	0.062	1.57	160	11	640	44	3.000	76	28	0.102	0.152
103-0750062	3/4	0.750	± 0.006	19.05	± 0.152	0.625	± 0.006	15.88	± 0.152	0.062	1.57	130	9	520	36	6.000	152	28	0.125	0.186
103-1000062	1	1.000	± 0.010	25.40	± 0.254	0.875	± 0.010	22.22	± 0.254	0.062	1.57	90	6	360	25	8.000	203	28	0.170	0.253

Colors

- Standard is natural
- Colors available as custom run

Color Code			Color Code		
○	N	Natural	●	5	Green
●	0	Black	●	6	Blue
●	1	Brown	●	7	Violet
●	2	Red	●	8	Gray
●	3	Orange	○	9	White
●	4	Yellow			



WARNING

This product can expose you to chemicals including Tetrafluoroethylene, which is known to the State of California to cause cancer. For more information go to www.P65Warnings.ca.gov.

FEP Tubing

Series 203

Series 203 - FEP Metric Size Tubing

Part Number	Order Size	Nominal O.D.			Nominal I.D.			Reference Wall Thickness		Working Pressure 73°F (23°C)		Minimum Burst Pressure		Minimum Bend Radius		Vac. Rating	Weight			
		mm	mm	tol.	inch	tol.	mm	tol.	inch	tol.	mm	inch	bar	psi	bar		psi	mm	inch	kg/mtr
203-0300100	3	3	± 0.11	0.118	± 0.004	1	± 0.11	0.039	± 0.004	1	0.039	27	390	108	1560	6	0.250	28	0.014	0.009
203-0400100	4	4	± 0.11	0.157	± 0.004	2	± 0.11	0.079	± 0.004	1	0.039	20	290	80	1160	13	0.500	28	0.020	0.014
203-0500100	5	5	± 0.11	0.197	± 0.004	3	± 0.11	0.118	± 0.004	1	0.039	15	220	61	880	19	0.750	28	0.027	0.018
203-0600100	6	6	± 0.13	0.236	± 0.005	4	± 0.13	0.157	± 0.005	1	0.039	12	180	50	720	29	1.125	28	0.034	0.023
203-0700100	7	7	± 0.13	0.276	± 0.005	5	± 0.13	0.197	± 0.005	1	0.039	10	150	41	600	44	1.750	28	0.041	0.027
203-0800100	8	8	± 0.13	0.315	± 0.005	6	± 0.13	0.236	± 0.005	1	0.039	9	130	36	520	51	2.000	28	0.047	0.032
203-0900100	9	9	± 0.13	0.354	± 0.005	7	± 0.13	0.275	± 0.005	1	0.039	8	110	30	440	54	2.125	28	0.054	0.036
203-1000100	10	10	± 0.13	0.393	± 0.005	8	± 0.13	0.315	± 0.005	1	0.039	7	100	28	400	70	2.750	28	0.061	0.041
203-1200100	12	12	± 0.15	0.472	± 0.006	10	± 0.15	0.394	± 0.006	1	0.039	6	80	22	320	76	3.000	28	0.074	0.050

Colors

- Standard is natural
- Colors available as custom run

Color Code			Color Code		
○	N	Natural	●	5	Green
●	0	Black	●	6	Blue
●	1	Brown	●	7	Violet
●	2	Red	●	8	Gray
●	3	Orange	○	9	White
●	4	Yellow			



WARNING

This product can expose you to chemicals including Tetrafluoroethylene, which is known to the State of California to cause cancer. For more information go to www.P65Warnings.ca.gov.

FEP Heat Shrinkable Tubing

Series HS1.3FEP, HS1.6FEP

Lower shrink temperature than PTFE.

Supplied in expanded state, allowing for easy installation.

1.3/1 Heat Shrink Ratio

1.6/1 Heat Shrink Ratio



Features

- Easier to shrink than PTFE
- Chemically inert
- Low coefficient of friction
- Superior dielectric strength
- Good heat resistance
- Self extinguishing
- Non-wetting

Compliance

- ASTM D2902 Type II
- ASTM D3296
- Dimensionally compliant to AS23053/11
- 21 CFR 177.1550 Compliant
- USP Class VI Compliant
- UL94V-0

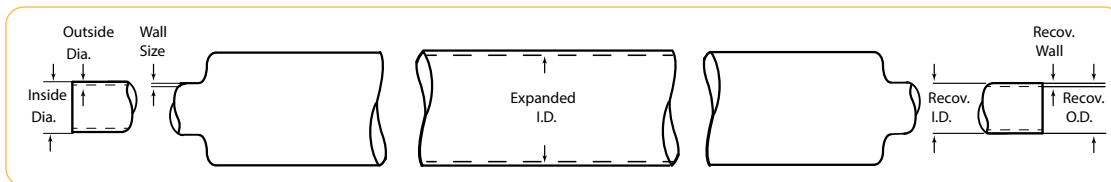

Notes

- Working Temperature: °F (-73°C) to 400°F (204°C)
- Shrink Temperature: 1" Dia. and below : 410°F (210°C) Over 1" Dia. : 430°F (221°C)
- *Dielectric Strength: > 2,000 v/m, per ASTM D 149 short term test of 10 MIL thickness (volts/mil)
- Available in stock packaging of 4-ft. straight lengths
- When ordering coiled tubing in colors, the color code is always followed by TC; when ordering cut lengths, the color code is followed by CC
i.e. HS1.3FEP24-2TC
i.e. HS1.3FEP24-OCC48.000

Order Information

Example: HS1.3FEP24-NT

- HS1.3FEP24-NT – Heat Shrink Tubing
- HS1.3FEP24-NT – Shrink Ratio (1:3)
- HS1.3FEP24-NT – FEP
- HS1.3FEP24-NT – Heat Shrink Size in AWG (AWG24)
- HS1.3FEP24-NT – Natural
- HS1.3FEP24-NT – Bulk Tubing - Coil

Colors

- ○ Standard is natural
- Colors available as custom run

Color Code			Color Code		
○	N	Natural	●	5	Green
●	0	Black	●	6	Blue
●	1	Brown	●	7	Violet
●	2	Red	●	8	Gray
●	3	Orange	○	9	White
●	4	Yellow			

Order Information

Example: HS1.6FEP3/32-NC48.000

- HS1.6FEP3/32-NC48.000 – Heat Shrink Tubing
- HS1.6FEP3/32-NC48.000 – Shrink Ratio (1.67:1)
- HS1.6FEP3/32-NC48.000 – FEP
- HS1.6FEP3/32-NC48.000 – Heat Shrink Size in inches (3/32")
- HS1.6FEP3/32-NC48.000 – Natural
- HS1.6FEP3/32-NC48.000 – Cut Tubing
- HS1.6FEP3/32-NC48.000 – Cut length in inches (48")



WARNING

This product can expose you to chemicals including Tetrafluoroethylene, which is known to the State of California to cause cancer. For more information go to www.P65Warnings.ca.gov.

FEP Heat Shrinkable Tubing

Series HS1.3FEP, HS1.6FEP

Series HS1.3FEP - 1.3:1 AWG & Fractional Heat Shrink Tubing

Part Number	Mil Spec Part Number	Order Size	Minimum Expanded I.D.		Maximum Recovered I.D.		Nominal Recovered Wall		Weight	
			inch	mm	inch	mm	inch	mm	lb/ft	kg/mtr
HS1.3FEP24	M23053/11-101-*	AWG24	0.031	0.79	0.027	0.69	0.008 ± 0.002	0.20 ± 0.05	0.0008	0.0012
HS1.3FEP22	M23053/11-102-C	AWG22	0.036	0.91	0.032	0.81	0.008 ± 0.002	0.20 ± 0.05	0.0009	0.0013
HS1.3FEP20	M23053/11-103-C	AWG20	0.045	1.14	0.039	0.99	0.008 ± 0.002	0.20 ± 0.05	0.0011	0.0016
HS1.3FEP18	M23053/11-104-C	AWG18	0.060	1.52	0.049	1.25	0.008 ± 0.002	0.20 ± 0.05	0.0013	0.0019
HS1.3FEP16	M23053/11-105-C	AWG16	0.075	1.90	0.061	1.55	0.009 ± 0.002	0.23 ± 0.05	0.0018	0.0027
HS1.3FEP14	M23053/11-106-C	AWG14	0.092	2.34	0.072	1.83	0.009 ± 0.002	0.23 ± 0.05	0.0021	0.0031
HS1.3FEP12	M23053/11-107-C	AWG12	0.115	2.92	0.089	2.26	0.009 ± 0.002	0.23 ± 0.05	0.0026	0.0039
HS1.3FEP10	M23053/11-108-C	AWG10	0.141	3.58	0.114	2.90	0.010 ± 0.003	0.25 ± 0.08	0.0036	0.0054
HS1.3FEP09	M23053/11-109-C	AWG09	0.158	4.01	0.124	3.15	0.010 ± 0.003	0.25 ± 0.08	0.0039	0.0058
HS1.3FEP08	M23053/11-110-C	AWG08	0.180	4.57	0.143	3.63	0.010 ± 0.003	0.25 ± 0.08	0.0045	0.0067
HS1.3FEP07	M23053/11-111-C	AWG07	0.197	5.00	0.158	4.01	0.011 ± 0.004	0.28 ± 0.10	0.0054	0.0080
HS1.3FEP06	M23053/11-112-C	AWG06	0.225	5.72	0.180	4.57	0.011 ± 0.004	0.28 ± 0.10	0.0061	0.0091
HS1.3FEP05	M23053/11-113-C	AWG05	0.248	6.30	0.198	5.03	0.011 ± 0.004	0.28 ± 0.10	0.0067	0.0100
HS1.3FEP04	M23053/11-114-C	AWG04	0.290	7.37	0.226	5.74	0.011 ± 0.004	0.28 ± 0.10	0.0076	0.0113
HS1.3FEP03	M23053/11-115-C	AWG03	0.310	7.87	0.249	6.32	0.011 ± 0.003	0.28 ± 0.10	0.0084	0.0125
HS1.3FEP02	M23053/11-116-C	AWG02	0.365	9.27	0.280	7.11	0.012 ± 0.004	0.31 ± 0.10	0.0103	0.0153
HS1.3FEP01	M23053/11-117-C	AWG01	0.400	10.2	0.311	7.90	0.012 ± 0.004	0.31 ± 0.10	0.0113	0.0168
HS1.3FEP00	M23053/11-118-C	AWG00	0.440	11.2	0.349	8.86	0.012 ± 0.004	0.31 ± 0.10	0.0127	0.0189
HS1.3FEP3/8	M23053/11-119-C	3/8	0.500	12.7	0.383	9.7	0.015 ± 0.004	0.38 ± 0.10	0.018	0.026
HS1.3FEP7/16	M23053/11-120-C	7/16	0.580	14.7	0.448	11.4	0.020 ± 0.004	0.51 ± 0.10	0.030	0.044
HS1.3FEP1/2	M23053/11-121-C	1/2	0.666	16.9	0.510	13.0	0.020 ± 0.004	0.51 ± 0.10	0.031	0.046
HS1.3FEP5/8	M23053/11-122-C	5/8	0.830	21.1	0.637	16.2	0.025 ± 0.004	0.64 ± 0.10	0.048	0.072
HS1.3FEP3/4	M23053/11-123-C	3/4	1.000	25.4	0.764	19.4	0.030 ± 0.004	0.76 ± 0.10	0.070	0.104
HS1.3FEP7/8	M23053/11-124-C	7/8	1.170	29.7	0.891	22.6	0.035 ± 0.004	0.89 ± 0.10	0.095	0.141
HS1.3FEP1.00	M23053/11-126-C	1	1.330	33.8	1.020	25.9	0.035 ± 0.004	0.89 ± 0.10	0.108	0.161
HS1.3FEP1.13	M23053/11-133-C	1-1/8	1.500	38.1	1.145	29.1	0.035 ± 0.004	0.89 ± 0.10	0.121	0.180
HS1.3FEP1.25	M23053/11-134-C	1-1/4	1.666	42.3	1.270	32.3	0.035 ± 0.004	0.89 ± 0.10	0.134	0.199
HS1.3FEP1.38	M23053/11-135-C	1-3/8	1.833	46.6	1.390	35.3	0.035 ± 0.004	0.89 ± 0.10	0.146	0.217
HS1.3FEP1.50	M23053/11-136-C	1-1/2	2.000	50.8	1.520	38.6	0.035 ± 0.004	0.89 ± 0.10	0.159	0.237

Series HS1.6FEP - 1.67:1 Heat Shrink Tubing

Part Number	Mil Spec Part Number	Order Size	Minimum Expanded I.D.		Maximum Recovered I.D.		Nominal Recovered Wall		Weight	
			inch	mm	inch	mm	inch	mm	lb/ft	kg/mtr
HS1.6FEP3/32	M23053/11-201-C	3/32	0.093	2.36	0.056	1.42	0.008 ± 0.003	0.20 ± 0.08	0.0015	0.0022
HS1.6FEP1/8	M23053/11-202-C	1/8	0.125	3.18	0.075	1.90	0.010 ± 0.003	0.25 ± 0.08	0.0025	0.0037
HS1.6FEP3/16	M23053/11-203-C	3/16	0.188	4.78	0.115	2.92	0.010 ± 0.003	0.25 ± 0.08	0.0037	0.0055
HS1.6FEP1/4	M23053/11-204-C	1/4	0.250	6.35	0.150	3.81	0.010 ± 0.003	0.25 ± 0.08	0.0047	0.0070
HS1.6FEP3/8	M23053/11-205-C	3/8	0.375	9.52	0.225	5.72	0.012 ± 0.003	0.31 ± 0.08	0.0083	0.0124
HS1.6FEP1/2	M23053/11-206-C	1/2	0.500	12.70	0.300	7.62	0.015 ± 0.004	0.38 ± 0.10	0.0138	0.0205
HS1.6FEP3/4	M23053/11-207-C	3/4	0.750	19.10	0.450	11.40	0.020 ± 0.004	0.51 ± 0.10	0.0275	0.0409
HS1.6FEP1.00	M23053/11-208-C	1	1.000	25.40	0.600	15.20	0.025 ± 0.005	0.64 ± 0.13	0.0457	0.0680
HS1.6FEP1.50	M23053/11-209-C	1-1/2	1.500	38.10	0.900	22.90	0.030 ± 0.005	0.76 ± 0.13	0.0817	0.1216
HS1.6FEP2.00	M23053/11-210-C	2	2.000	50.80	1.200	30.50	0.030 ± 0.005	0.76 ± 0.13	0.1080	0.1607



WARNING

This product can expose you to chemicals including Tetrafluoroethylene, which is known to the State of California to cause cancer. For more information go to www.P65Warnings.ca.gov.

FEP Heat Shrinkable Tubing

Series HS1.25FEP, Roll Cover

Roll cover supplied expanded, allowing easy slippage over rollers.

1.25/1 Heat Shrink Ratio



Features

- Extends roller life
- Eliminates roller build up and picking
- Low coefficient of friction
- Flexible
- Good heat resistance

Compliance

- ASTM D2902 Type II
- Dimensionally compliant to AS23053/11
- UL94V-0

Notes

- Working Temperature: °F (-73°C) to 400°F (204°C)
- Shrink Temperature: 347°F (175°C) for 10 minutes - For high temperatures 500°F (260°C), PFA roll covers are available
- *Dielectric Strength: > 2,000 v/m, per ASTM D 149 short term test of 10 MIL thickness (volts/mil)
- Roll Cover is available in stock packaging of 4-ft. straight lengths
- For adhesion purposes, roll covers must be etched; Etching is available on the inside diameter, outside diameter or both

Colors

- ○ Standard is natural
- Colors available as custom run

Color Code			Color Code		
○	N	Natural	●	5	Green
●	0	Black	●	6	Blue
●	1	Brown	●	7	Violet
●	2	Red	●	8	Gray
●	3	Orange	○	9	White
●	4	Yellow			

Order Information

Example: **HS1.25FEP3.50-NC48.000**

HS1.25FEP3.50-NC48.000 – Heat Shrink Tubing

HS1.25FEP3.50-NC48.000 – Shrink Ratio (1.25:1)

HS1.25FEP3.50-NC48.000 – FEP

HS1.25FEP3.50-NC48.000 – Heat Shrink Expanded Size in inches (3-1/2")

HS1.25FEP3.50-NC48.000 – Natural

HS1.25FEP3.50-NC48.000 – Cut Tubing

HS1.25FEP3.50-NC48.000 – Cut length in inches (48")



WARNING

This product can expose you to chemicals including Tetrafluoroethylene, which is known to the State of California to cause cancer. For more information go to www.P65Warnings.ca.gov.

FEP Heat Shrinkable Tubing

Series HS1.25FEP, Roll Cover

Series HS1.25FEP - 1.25:1 FEP Heat Shrink Tubing

Part Number	Mil Spec Part Number	Order Size	Minimum Expanded I.D.		Maximum Recovered I.D.		Nominal Recovered Wall		Weight	
			inch	mm	inch	mm	inch	mm	lb/ft	kg/mtr
HS1.25FEP1.00	-	1	1.100	27.9	0.880	22.4	0.020 ± 0.004	0.508 +0.10	0.053	0.078
HS1.25FEP1.25	-	1-1/4	1.300	33	1.000	25.4	0.020 ± 0.004	0.508 +0.10	0.060	0.089
HS1.25FEP1.50	M23053/11-127-C	1-1/2	1.700	43.2	1.300	33	0.020 ± 0.004	0.508 +0.10	0.077	0.115
HS1.25FEP2.00	M23053/11-128-C	2	2.100	53.3	1.700	43.2	0.020 ± 0.004	0.508 +0.10	0.101	0.150
HS1.25FEP2.25	-	2-1/4	2.260	59.7	2.000	50.8	0.020 ± 0.004	0.508 +0.10	0.118	0.176
HS1.25FEP2.50	M23053/11-129-C	2-1/2	2.600	66	2.100	53.3	0.020 ± 0.004	0.508 +0.10	0.124	0.185
HS1.25FEP3.00	M23053/11-130-C	3	3.100	78.7	2.600	66	0.020 ± 0.004	0.508 +0.10	0.153	0.228
HS1.25FEP3.50	M23053/11-131-C	3-1/2	3.500	88.9	3.100	78.7	0.020 ± 0.004	0.508 +0.10	0.183	0.272
HS1.25FEP4.00	M23053/11-132-C	4	4.300	109.2	3.500	88.9	0.020 ± 0.004	0.508 +0.10	0.206	0.307
HS1.25FEP5.00	-	5	5.200	132.1	4.300	109.3	0.020 ± 0.004	0.508 +0.10	0.253	0.376

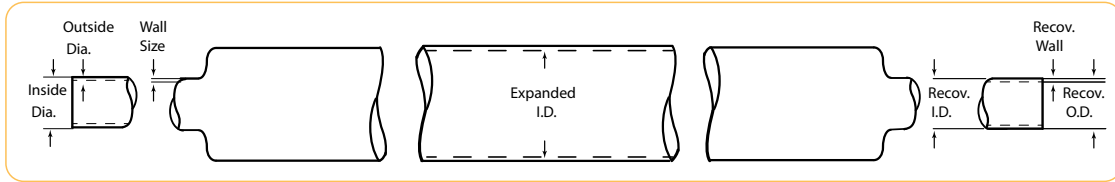

Colors

- Standard is natural
- Colors available as custom run

Color Code			Color Code		
○	N	Natural	●	5	Green
●	0	Black	●	6	Blue
●	1	Brown	●	7	Violet
●	2	Red	●	8	Gray
●	3	Orange	○	9	White
●	4	Yellow			



WARNING

This product can expose you to chemicals including Tetrafluoroethylene, which is known to the State of California to cause cancer. For more information go to www.P65Warnings.ca.gov.

FEP Convoluted Tubing

Series CV03, 81914/3

High temperature electrical insulation
in long, continuous lengths.

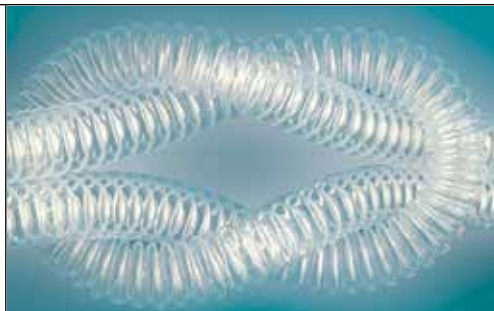

Features

- Cuffs are sized on the I.D.
- Very flexible
- Long continuous lengths
- Translucent
- Chemically inert
- Good flexlife

Notes

- Working Temperature: CV03 °F (-73°C) to 400°F (204°C)
81914 °F (-73°C) to 392°F (200°C)
- Wire wrap reinforcement can be added for increased pressure applications or when a tighter bend radius is needed
- ** Minimum 36" length

Fittings

Parker Fittings available from:
Fluid System Connectors Division
Otsego, MI

(269) 692-6555
(269) 692-6634 FAX
parker.com/fsc

For approved fittings and/or suggested use of tube supports, reference Tube/Fitting Compatibility Chart (pg. B-8/B-9) or contact Parker Fluid Systems Connectors Division

Compliance

CV03

- ASTM D3296
- 21 CFR 177.1550 Compliant
- USP Class VI
- UL94V-0

SAE AS81914

- Dimensionally compliant to AS81914/3 and AS81914/4

Order Information

Example: CV03-1/8-NT

CV03-1/8-NT – Convoluted

CV03-1/8-NT – FEP

CV03-1/8-NT – Tube Size in inches (1/8")

CV03-1/8-NT – Natural

CV03-1/8-NT – Bulk Tubing "T" is bulk (for cuffed tubing, remove "T" and add length, ie. CV03-1/8-N1200 = 1/8" Convo FEP, natural, cut 12" long)

Standard Cuffs for FEP Convo
are sized on the I.D.

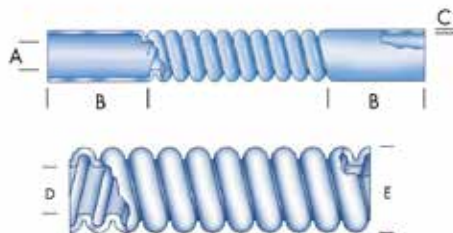

Order Information

Example: 81914/3-1001-NT

81914/3-1001-NT – Mil Spec Convoluted

81914/3-1001-NT – FEP

81914/3-1001-NT – Helical Convolutions

81914/3-1001-NT – Size 01 = 0.187"

81914/3-1001-NT – Natural

81914/3-1001-NT – Bulk Tubing "T" is bulk



WARNING

This product can expose you to chemicals including Tetrafluoroethylene, which is known to the State of California to cause cancer. For more information go to www.P65Warnings.ca.gov.

FEP Convoluted Tubing

Series CV03, 81914/3

Series CV03 - FEP Convoluted Tubing

Part Number	Order Size	Standard Cuff I.D. "A"		Standard Cuff Length "B"		Wall Thickness "C"		Minimum Inside Diameter "D"		Maximum Inside Diameter "D"		Maximum Outside Diameter "E"		**Minimum Bend Radius		Weight	
		inch	mm	inch	mm	inch	mm	inch	mm	inch	mm	inch	mm	inch	mm	lb/ft	kg/mtr
CV03-1/4-NT	1/4	1/4	6.35	3/4	19.1	0.020	0.508	0.251	6.38	0.265	6.73	0.405	10.3	0.365	9	0.320	8.1
CV03-5/16-NT	5/16	5/16	7.94	1	25.4	0.023	0.584	0.273	6.93	0.281	7.14	0.424	10.8	0.500	13	0.414	10.5
CV03-3/8-NT	3/8	3/8	9.53	1	25.4	0.023	0.584	0.364	9.25	0.375	9.53	0.530	13.5	0.875	22	0.450	11.4
CV03-1/2-NT	1/2	1/2	12.70	1	25.4	0.025	0.635	0.485	12.30	0.500	12.70	0.660	16.8	0.625	16	0.590	15.0
CV03-5/8-NT	5/8	5/8	15.90	1-1/4	31.8	0.025	0.635	0.609	15.50	0.625	15.90	0.780	19.8	1.500	38	0.660	16.8
CV03-3/4-NT	3/4	3/4	19.10	1-1/2	38.1	0.025	0.635	0.730	18.50	0.750	19.10	0.975	24.8	3.500	89	0.780	19.8
CV03-1.00-NT	1.00	1.000	25.40	2.000	50.8	0.030	0.762	0.975	24.80	1.000	25.40	1.260	32.0	2.250	57	1.100	27.9

Series 81914/3 Convoluted Tubing

Part Number	Order Size	Maximum Inside Diameter		Minimum Inside Diameter		Maximum Outside Diameter		Maximum Wall Thickness		*Minimum Bend Radius		Pitch	Weight	
		inch	mm	inch	mm	inch	mm	inch	mm	inch	mm		lb/ft	kg/mtr
81914/3-1001-NT	-1	0.187	4.75	0.181	4.60	0.320	8.13	0.018	0.457	1/2	13	8	1.5	2.23
81914/3-1002-NT	-2	0.281	7.14	0.273	6.93	0.414	10.5	0.018	0.457	3/4	19	8	1.7	2.53
81914/3-1003-NT	-3	0.312	7.93	0.306	7.77	0.450	11.4	0.018	0.457	3/4	19	8	1.9	2.83
81914/3-1004-NT	-4	0.375	9.53	0.364	9.25	0.510	13.0	0.018	0.457	7/8	22	8	2.2	3.27
81914/3-1005-NT	-5	0.437	11.10	0.427	10.9	0.571	14.5	0.018	0.457	7/8	22	8	3.1	4.61
81914/3-1006-NT	-6	0.500	12.70	0.485	12.3	0.650	16.5	0.023	0.584	1-1/4	32	7	4.0	5.95
81914/3-1007-NT	-7	0.625	15.90	0.608	15.4	0.770	19.6	0.023	0.584	1-1/2	38	7	4.8	7.14
81914/3-1008-NT	-8	0.750	19.10	0.730	18.5	0.930	23.6	0.023	0.584	1-3/4	44	6	6.1	9.07
81914/3-1009-NT	-9	0.875	22.20	0.860	21.8	1.073	27.3	0.023	0.584	2	51	5	7.0	10.4
81914/3-1010-NT	-10	1.000	25.40	0.975	24.8	1.226	31.1	0.023	0.584	2.370	60	5	8.5	12.7
81914/3-1011-NT	-11	1.125	28.60	1.105	28.1	1.390	35.3	0.023	0.584	2.370	60	5	9.3	13.8
81914/3-1012-NT	-12	1.250	31.80	1.210	30.7	1.539	39.1	0.023	0.584	2-3/4	70	4	10.9	16.2

FEP convoluted tubing is provided in NATURAL without cuffs directly from the factory. Natural part numbers are designated with "NT" after the Mil Spec number (i.e. 81914/3-1014). Also available in 81914/4 (Close Convolution).

Colors

- Standard is natural
- Colors available as custom run

Color Code			Color Code		
○	N	Natural	●	5	Green
●	0	Black	●	6	Blue
●	1	Brown	●	7	Violet
●	2	Red	●	8	Gray
●	3	Orange	○	9	White
●	4	Yellow			



WARNING

This product can expose you to chemicals including Tetrafluoroethylene, which is known to the State of California to cause cancer. For more information go to www.P65Warnings.ca.gov.

FEP Corrugated Tubing

Series CR03

Turn sharp corners without kinking or slowing flow.



Features

- Capable of turning sharp corners without reducing the inside diameter of the tube
- Extremely flexible
- Kink resistant
- Non stick surface allows for easy cleaning
- Excellent clarity
- Chemically inert
- Available in FEP, PFA and High Purity PFA

Compliance

- FEP - ASTM D3296
- PFA - ASTM D3307
- 21 CFR 177.1550 Compliant
- USP Class VI Compliant
- UL94V-0

Colors

- ○ Natural, translucent

Notes

- Working Temperature: -100°F (-73°C) to 200°F (93°C)
For higher temperatures, request PFA Corrugated (CR04) -100°F (-75°C) to 300°F (148°C) @ 0 pressure
- Vacuum Service: 29.9 IN. Hg (759M Hg)
- Extension-Compression Length Ratio: Approximately 2:1
- Tubing is provided in natural in custom lengths with a maximum length of 12 feet/3 meters
- Corrugated tubing is also available in specialty configurations where corrugated and straight tubing run intermittently along the tube

Fittings

Parker Fittings available from:
Fluid System Connectors Division
Otsego, MI

(269) 692-6555
(269) 692-6634 FAX
parker.com/fsc

For approved fittings and/or suggested use of tube supports, reference Tube/Fitting Compatibility Chart (pg. B-8/B-9) or contact Parker Fluid Systems Connectors Division

Order Information CR03-1.00-NC29.000-2C

- CR03-1.00-NC29.000-2C – **Corrugated Tubing**
- CR03-1.00-NC29.000-2C – **Material FEP**
- CR03-**1.00**-NC29.000-2C – **Tube Size** (Nominal I.D. in inches (1"))
- CR03-1.00-**NC**29.000-2C – **Color Natural**
- CR03-1.00-NC**29**.000-2C – **Cut Piece**
- CR03-1.00-NC**29.000**-2C – **Overall Length** in inches (29")
- CR03-1.00-NC29.000-**2C** – **Standard Cuff on each end**



WARNING

This product can expose you to chemicals including Tetrafluoroethylene, which is known to the State of California to cause cancer. For more information go to www.P65Warnings.ca.gov.

FEP Corrugated Tubing

Series CR03

Series CR03 - FEP Corrugated Tubing

Part Number	Order Size	Maximum Cuff I.D. "A"		Standard Cuff Length "B"		Wall Thickness "C"		Reference Outside Diameter "D"		Corrugated Length "E" ±1	**Minimum Bend Radius		Weight	
		inch	mm	inch	mm	inch	mm	inch	mm		inch	mm	lb/ft	kg/mtr
CR03-1/4-NT	1/4	0.250	6.35	3/4	19.1	0.015	0.38	0.375	9.53	To be specified at time of order	0.125	3.18	0.125	3.18
CR03-3/8-NT	3/8	0.375	9.53	1	25.4	0.020	0.51	0.625	15.9		0.187	4.76	0.187	4.76
CR03-1/2-NT	1/2	0.500	12.7	1	25.4	0.025	0.64	0.750	19.0		0.250	6.35	0.250	6.35
CR03-5/8-NT	5/8	0.625	15.9	1	25.4	0.025	0.64	0.938	23.8		0.312	7.94	0.312	7.94
CR03-3/4-NT	3/4	0.750	19.1	1-1/2	38.1	0.030	0.76	1.063	26.9		0.375	9.53	0.375	9.53
CR03-7/8-NT	7/8	0.875	22.2	1-1/2	38.1	0.030	0.76	1.250	31.8		0.438	11.1	0.438	11.1
CR03-1.00-NT	1	1.000	24.8	2	50.8	0.035	0.89	1.438	36.5		0.500	12.7	0.500	12.7
CR03-1.25-NT	1-1/4	1.250	31.8	2	50.8	0.035	0.89	1.625	41.3		0.625	15.9	0.625	15.9
CR03-1.50-NT	1-1/2	1.500	38.1	2	50.8	0.035	0.89	1.813	46.1		0.750	19.1	0.750	19.1
CR03-2.00-NT	2	2.000	50.8	2	50.8	0.040	1.02	2.625	66.7		1.000	25.4	1.000	25.4
CR03-2.50-NT	2-1/2	2.500	63.8	2-1/2	63.5	0.070	1.78	3.360	85.3		2.500	63.5	2.500	63.5

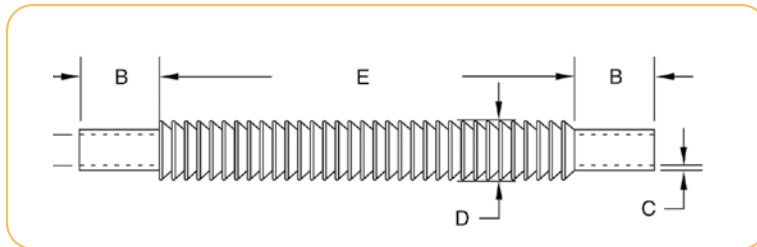

WARNING

This product can expose you to chemicals including Tetrafluoroethylene, which is known to the State of California to cause cancer. For more information go to www.P65Warnings.ca.gov.

PFA Tubing

Series 104, 105, 204, 205: Fractional & Metric

Combines the high temperature of PTFE with the long continuous lengths of FEP



Features

- Virgin Perfluoroalkoxy
- Translucent
- Low permeability
- Exceptional heat resistance
- Chemically inert
- Long continuous lengths
- Low coefficient of friction
- Self extinguishing
- Non-wetting
- Non leaching

High Purity (105, 205)

- Withstands corrosive surfactants for longer periods of time
- Highest molecular weight available

Compliance

- ASTM D3307
- 21 CFR 177.1550 Compliant
- USP Class VI
- UL94V-0

Notes

- Working Temperature: °F (-75°C) to 500°F (260°C)
- Vacuum Rating 28 @ 73°F
- Working pressure calculated using a Design Factor of 4
- Custom packaging and sizes are quoted upon request

PFA Tubing (Series 104, 105, 204, 205) Maximum Working Pressure (psi)

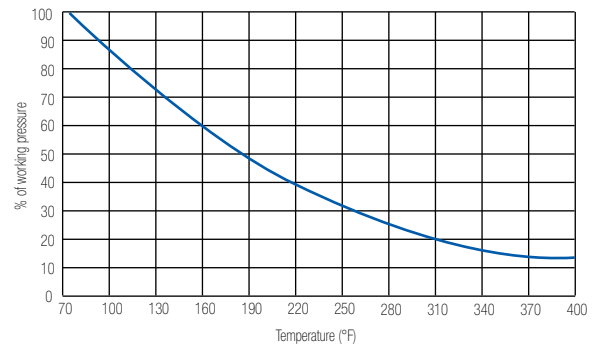

Fittings

Parker Fittings available from:
Fluid System Connectors Division
Otsego, MI

(269) 692-6555
(269) 692-6634 FAX
parker.com/fsc

For approved fittings and/or suggested use of tube supports, reference Tube/Fitting Compatibility Chart (pg. B-8/B-9) or contact Parker Fluid Systems Connectors Division

Order Information

Example: 104-0188062-NT-100

- 104-0188062-NT-100 – PFA
- 104-**0188**062-NT-100 – Tube O.D. in inches (3/16")
- 104-0188**062**-NT-100 – Tube Wall Thickness in inches (.062")
- 104-0188062-**NT**-100 – Natural
- 104-0188062-**NT**-100 – Bulk Tubing
- 104-0188062-NT-**100** – Package Quantity in feet (100')



WARNING

This product can expose you to chemicals including Tetrafluoroethylene, which is known to the State of California to cause cancer. For more information go to www.P65Warnings.ca.gov.

PFA Tubing

Series 104, 204

Series 104 - PFA Fractional Industrial Wall Tubing

Part Number	Order Size	Nominal O.D.				Nominal I.D.				Reference Wall Thickness		Working Pressure 73°F (23°C)		Minimum Burst Pressure		Minimum Bend Radius		Vac. Rating	Weight	
		inch	tol.	mm	tol.	inch	tol.	mm	tol.	inch	mm	psi	bar	psi	bar	inch	mm		lb./ft.	kg./mt
104-0094031	3/32	0.094	± 0.004	2.40	± 0.102	0.031	± 0.002	0.79	± 0.051	0.031	0.79	680	47	2720	188	0.250	6	28	0.006	0.009
104-0125031	1/8	0.125	± 0.004	3.18	± 0.102	0.064	± 0.004	1.63	± 0.102	0.031	0.79	500	34	2000	138	0.375	10	28	0.009	0.013
104-0156031	5/32	0.157	± 0.005	3.99	± 0.127	0.094	± 0.003	2.39	± 0.076	0.031	0.79	390	27	1560	108	0.625	16	28	0.011	0.016
104-0188031	3/16	0.188	± 0.005	4.78	± 0.127	0.125	± 0.005	3.18	± 0.127	0.031	0.79	320	22	1280	88	0.625	16	28	0.014	0.021
104-0250031	1/4	0.250	± 0.005	6.35	± 0.127	0.188	± 0.005	4.78	± 0.127	0.031	0.79	230	16	920	63	0.875	22	28	0.020	0.030
104-0312031	5/16	0.312	± 0.005	7.92	± 0.127	0.250	± 0.005	6.35	± 0.127	0.031	0.79	180	12	720	50	1.750	44	28	0.025	0.037
104-0375031	3/8	0.375	± 0.005	9.52	± 0.127	0.312	± 0.005	7.92	± 0.127	0.031	0.79	140	10	560	39	3.250	83	28	0.031	0.046
104-0438031	7/16	0.438	± 0.005	11.13	± 0.127	0.375	± 0.005	9.53	± 0.127	0.031	0.79	120	8	480	33	3.250	83	28	0.037	0.055
104-0500031	1/2	0.500	± 0.005	12.70	± 0.127	0.438	± 0.005	11.13	± 0.127	0.031	0.79	100	7	400	28	4.750	121	28	0.043	0.064
104-0563031	9/16	0.563	± 0.006	14.30	± 0.152	0.500	± 0.006	12.70	± 0.152	0.031	0.79	80	6	320	22	5.000	127	28	0.054	0.080

Series 104 - PFA Fractional Heavy Wall Tubing

104-0188062	3/16	0.188	± 0.005	4.78	± 0.127	0.064	± 0.005	1.63	± 0.127	0.062	1.57	630	43	2520	174	0.250	6	28	0.023	0.034
104-0250040	1/4	0.250	± 0.005	6.35	± 0.127	0.170	± 0.005	4.32	± 0.127	0.040	1.02	280	19	1120	77	1.250	32	28	0.025	0.037
104-0250047	1/4	0.250	± 0.005	6.35	± 0.127	0.156	± 0.005	3.96	± 0.127	0.047	1.19	340	23	1360	94	0.750	19	28	0.028	0.042
104-0250062	1/4	0.250	± 0.005	6.35	± 0.127	0.125	± 0.005	3.18	± 0.127	0.062	1.57	470	32	1880	130	0.750	19	28	0.034	0.051
104-0312062	5/16	0.312	± 0.005	7.92	± 0.127	0.188	± 0.005	4.78	± 0.127	0.062	1.57	360	25	1440	99	1.375	35	28	0.045	0.067
104-0375062	3/8	0.375	± 0.005	9.52	± 0.127	0.250	± 0.005	6.35	± 0.127	0.062	1.57	290	20	1160	80	1.500	38	28	0.057	0.085
104-0438062	7/16	0.438	± 0.005	11.13	± 0.127	0.312	± 0.005	7.92	± 0.127	0.062	1.57	250	17	1000	69	2.625	67	28	0.068	0.101
104-0500062	1/2	0.500	± 0.005	12.70	± 0.127	0.375	± 0.005	9.53	± 0.127	0.062	1.57	210	14	840	58	2.125	54	28	0.079	0.118
104-0625062	5/8	0.625	± 0.006	15.88	± 0.152	0.500	± 0.006	12.70	± 0.152	0.062	1.57	160	11	640	44	3.000	76	28	0.102	0.152
104-0750062	3/4	0.750	± 0.006	19.05	± 0.152	0.625	± 0.006	15.88	± 0.152	0.062	1.57	130	9	520	36	6.000	152	28	0.125	0.186
104-1000062	1	1.000	± 0.010	25.40	± 0.254	0.875	± 0.010	22.22	± 0.254	0.062	1.57	90	6	360	25	8.000	203	28	0.170	0.253

Series 204 - PFA Metric Size Tubing

Part Number	Order Size	Nominal O.D.				Nominal I.D.				Reference Wall Thickness		Working Pressure 73°F (23°C)		Minimum Burst Pressure		Minimum Bend Radius		Vac. Rating	Weight	
		mm	mm	tol.	inch	tol.	mm	tol.	inch	tol.	mm	inch	bar	psi	bar	psi	mm		inch	kg/mtr
204-0400100	4	4	± 0.11	0.157	± 0.004	2	± 0.11	0.079	± 0.004	1	0.039	20	290	80	1160	13	0.500	28	0.020	0.014
204-0600100	6	6	± 0.13	0.236	± 0.005	4	± 0.13	0.157	± 0.005	1	0.039	12	180	50	720	29	1.125	28	0.034	0.023
204-0800100	8	8	± 0.13	0.315	± 0.005	6	± 0.13	0.236	± 0.005	1	0.039	9	130	36	520	51	2.000	28	0.047	0.032
204-1000100	10	10	± 0.13	0.393	± 0.005	8	± 0.13	0.315	± 0.005	1	0.039	7	100	28	400	70	2.750	28	0.061	0.041
204-1200100	12	12	± 0.15	0.472	± 0.006	10	± 0.15	0.394	± 0.006	1	0.039	6	80	22	320	76	3.000	28	0.074	0.050

Colors

- Standard is natural
- Colors available as custom run

Color Code			Color Code		
○	N	Natural	●	5	Green
●	0	Black	●	6	Blue
●	1	Brown	●	7	Violet
●	2	Red	●	8	Gray
●	3	Orange	○	9	White
●	4	Yellow			



WARNING

This product can expose you to chemicals including Tetrafluoroethylene, which is known to the State of California to cause cancer. For more information go to www.P65Warnings.ca.gov.

PFA Tubing - High Purity

Series 105, 205

Series 105 - High Purity PFA Fractional Industrial Wall Tubing

Part Number	Order Size	Nominal O.D.				Nominal I.D.				Reference Wall Thickness		Working Pressure 73°F (23°C)		Minimum Burst Pressure		Minimum Bend Radius		Vac. Rating	Weight	
		inch	tol.	mm	tol.	inch	tol.	mm	tol.	inch	mm	psi	bar	psi	bar	inch	mm		lb./ft.	kg./mt
105-0125031	1/8	0.125	± 0.004	3.18	± 0.102	0.064	± 0.004	1.63	± 0.102	0.031	0.79	500	34	2000	138	0.375	10	28	0.009	0.013
105-0188031	3/16	0.188	± 0.005	4.78	± 0.127	0.125	± 0.005	3.18	± 0.127	0.031	0.79	320	22	1280	88	0.625	16	28	0.014	0.021
105-0250031	1/4	0.250	± 0.005	6.35	± 0.127	0.188	± 0.005	4.78	± 0.127	0.031	0.79	230	16	920	63	0.875	22	28	0.020	0.030
105-0375031	3/8	0.375	± 0.005	9.52	± 0.127	0.312	± 0.005	7.92	± 0.127	0.031	0.79	140	10	560	39	3.250	83	28	0.031	0.046

Series 105 - High Purity PFA Fractional Heavy Wall Tubing

105-0250040	1/4	0.250	± 0.005	6.35	± 0.127	0.170	± 0.005	4.32	± 0.127	0.040	1.02	280	19	1120	77	1.250	32	28	0.025	0.037
105-0250047	1/4	0.250	± 0.005	6.35	± 0.127	0.156	± 0.005	3.96	± 0.127	0.047	1.19	340	23	1360	94	0.750	19	28	0.028	0.042
105-0250062	1/4	0.250	± 0.005	6.35	± 0.127	0.125	± 0.005	3.18	± 0.127	0.062	1.57	470	32	1880	130	0.750	19	28	0.034	0.051
105-0375062	3/8	0.375	± 0.005	9.52	± 0.127	0.250	± 0.005	6.35	± 0.127	0.062	1.57	290	20	1160	80	1.500	38	28	0.057	0.085
105-0500062	1/2	0.500	± 0.005	12.70	± 0.127	0.375	± 0.005	9.53	± 0.127	0.062	1.57	210	14	840	58	2.125	54	28	0.079	0.118
105-0750062	3/4	0.750	± 0.006	19.05	± 0.152	0.625	± 0.006	15.88	± 0.152	0.062	1.57	130	9	520	36	6.000	152	28	0.125	0.186
105-1000062	1	1.000	± 0.010	25.40	± 0.254	0.875	± 0.010	22.22	± 0.254	0.062	1.57	90	6	360	25	8.000	203	28	0.170	0.253

Series 205 - PFA High Purity Metric Size Tubing

Part Number	Order Size	Nominal O.D.				Nominal I.D.				Reference Wall Thickness		Working Pressure 73°F (23°C)		Minimum Burst Pressure		Minimum Bend Radius		Vac. Rating	Weight	
		mm	mm	tol.	inch	tol.	mm	tol.	inch	tol.	mm	inch	bar	psi	bar	psi	mm		inch	kg/mtr
205-0300100	3	3	± 0.11	0.118	± 0.004	1	± 0.11	0.039	± 0.004	1	0.039	27	390	108	1560	6	0.250	28	0.014	0.009
205-0400100	4	4	± 0.11	0.157	± 0.004	2	± 0.11	0.079	± 0.004	1	0.039	20	290	80	1160	13	0.500	28	0.020	0.014
205-0600100	6	6	± 0.13	0.236	± 0.005	4	± 0.13	0.157	± 0.005	1	0.039	12	180	50	720	29	1.125	28	0.034	0.023
205-0800100	8	8	± 0.13	0.315	± 0.005	6	± 0.13	0.236	± 0.005	1	0.039	9	130	36	520	51	2.000	28	0.047	0.032
205-1000100	10	10	± 0.13	0.393	± 0.005	8	± 0.13	0.315	± 0.005	1	0.039	7	100	28	400	70	2.750	28	0.061	0.041
205-1200100	12	12	± 0.15	0.472	± 0.006	10	± 0.15	0.394	± 0.006	1	0.039	6	80	22	320	76	3.000	28	0.074	0.050

Colors

- Standard is natural
- Colors available as custom run

Color Code			Color Code		
○	N	Natural	●	5	Green
●	0	Black	●	6	Blue
●	1	Brown	●	7	Violet
●	2	Red	●	8	Gray
●	3	Orange	○	9	White
●	4	Yellow			



WARNING

This product can expose you to chemicals including Tetrafluoroethylene, which is known to the State of California to cause cancer. For more information go to www.P65Warnings.ca.gov.

Notes

A Hose

Tubing
Fluoropolymer

Coiled Air Hose
& Fittings

Transportation

Fittings

Tooling,
Equipment
& Accessories

General
Technical



WARNING

This product can expose you to chemicals including Tetrafluoroethylene, which is known to the State of California to cause cancer. For more information go to www.P65Warnings.ca.gov.



Retractable Coiled Tubing

Fast-Stor®

NoMar® Fast-Stor®

FEP/PFA

Table of Contents

Retractable Coiled Tubing

Intro, Parflex Air Hose C-3

Fast-Stor® Air Hose C-4

NoMar® Fast-Stor® Air Hose C-7

Fluoropolymer Coils - FEP/PFA C-8

Fittings

Fast-Stor® Fittings C-5

How To Assemble..... C-6

Table of Contents

Visual Index

Retractable Coils

Fast-Stor®	Nomar® Fast-Stor®	FEP/PFA Coils
		
C-4	C-7	C-8

Fittings

Fast-Stor® Male

C-5

Parflex Air Hose

Nylon and 95 Durometer Polyurethane

Every hydraulic, pneumatic and lubrication system requires some form of tube line fabrication and fitting installation for completion. Proper fabrication and installation are essential for the overall efficiency, leak free performance, and general appearance of any system.

Start by planning ahead. After sizing the tube lines and selecting the appropriate style of fitting, consider the following in the design of your system:

- Accessibility of joints
- Adequate tube line supports
- Proper routing of lines
- Available fabricating tools

Routing of Lines

Routing of lines is probably the most difficult, yet most significant, of these system design considerations. Proper routing involves getting a connecting line from one point to another through the most logical path.

Always try to leave fitting joints as accessible as possible. Hard to reach joints are hard to assemble and tighten properly. Inaccessible joints are also more difficult and time consuming to service.

Size Selection Procedure

1. Determine air flow rate and pressure required by following air-tool manufacturers recommendations.
2. Refer to "Air Flow Characteristics" graphs, shown below. Find air flow requirement in standard cubic feet per minute (SCFM) on vertical line to left of graph. Now follow horizontal line on same graph to determine total extended length of hose required. Follow vertical
3. Note pressure drop above curve nearest to intersection of SCFM and hose length lines. Pressure drop, subtracted from line pressure, equals "available pressure" at the selected SCFM flow rate and hose length.
4. If "available pressure" is below the tool manufacturers' recommendations, refer to chart for successively larger hose sizes until an acceptable "available pressure" is found. Choose this size Fast-Stor® Air Hose for your application.
5. Refer to "working pressure vs. temperature" chart (pg. B-7) to be sure your application falls within the working range of Fast-Stor® Air Hose.

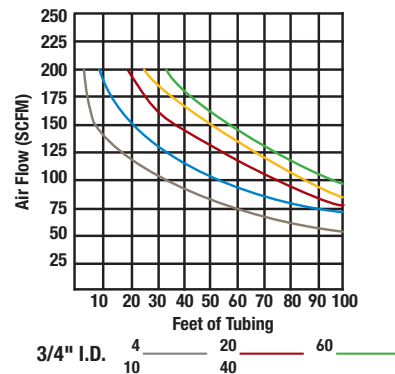
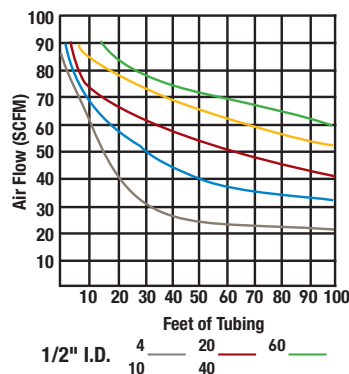
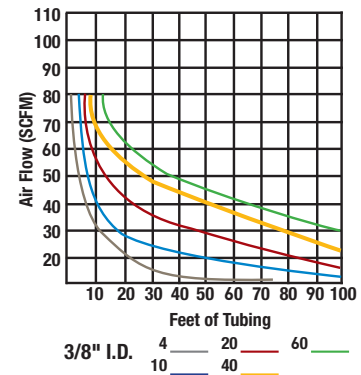
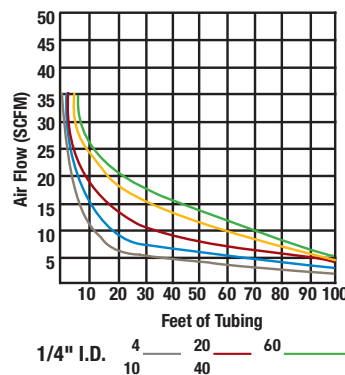
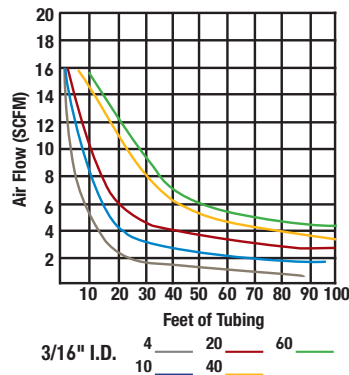

Actual working pressure charts are located in the tubing section on the specific product page.

Fast-Stor® Air Hose

Nylon

Manufactured from tough, abrasion-resistant nylon.



Features

- Excellent memory characteristics over a wide temperature range
- Long service life in rugged applications
- Safety yellow color per U.S. Government OSHA directives
- Spring guard protection at fittings connections

Notes

- Color: Yellow
- *Retail packaging available - Add "R" suffix when ordering
- Service temperature range: -40°F (-40°C) to 200°F (93°C)
- Maximum working pressure based on safety factor of 3:1 over burst
- Fittings for Fast-Stor® hose are constructed from heavy duty brass with built in insert-supports. Fitting bodies are SAE standard sizes.

Order Information

Example: A0412-MC4-ML4

A0412-MC4-ML4 – Air Hose

A0412-MC4-ML4 – Tube I.D. in sixteenths of an inch (1/4")

A0412-MC4-ML4 – Unit Length in feet (12')

A0412-MC4-ML4 – End Fitting 1 - Male Connector

A0412-MC4-ML4 – Size of End Fitting 1 (1/4")

A0412-MC4-ML4 – End Fitting 2 - Male Live Pipe Swivel

A0412-MC4-ML4 – Size of End Fitting 2 (1/4")

Series Fast-Stor Assemblies

Assembly Part Number	Hose I.D.		Nominal Coil O.D.		Unit Length		Extended Length		Nominal Compact Length		Working Pressure 73°F (23°C)		Minimum Burst Pressure		End Fittings	Color
	inch	mm	inch	mm	ft	mtr	ft	mtr	inch	mm	psi	bar	psi	bar		
A0412-MC4-ML4*	1/4	6	3-5/8	92	12	3.7	9.0	2.7	4-1/2	110	225	15.5	680	46.9	1/4" NPT	●
A0425-MC4-ML4*					25	7.6	18.8	5.7	9	228						
A0450-MC4-ML4					50	15.2	37.5	11.4	18	457						
A0612-MC6-ML6*	3/8	10	5-7/16	138	12	3.7	9.0	2.7	4	106	225	15.5	680	46.9	3/8" NPT	●
A0625-MC6-ML6					25	7.6	18.8	5.7	9	223						
A0650-MC6-ML6					50	15.2	37.5	11.4	17-1/2	447						
A0812-MC8-ML8	1/2	13	7-3/4	191	12	3.7	9.0	2.7	4-1/2	111	225	15.5	680	46.9	1/2" NPT	●
A0825-MC8-ML8					25	7.6	18.8	5.7	8	206						
A0850-MC8-ML8					50	15.2	37.5	11.4	17	427						



WARNING

This product can expose you to chemicals including Lead, which is known to the State of California to cause cancer and birth defects or other reproductive harm. For more information go to www.P65Warnings.ca.gov.

Fast-Stor® Fittings

Male Connections

Manufactured from heavy duty brass.



Features

- Constructed from heavy duty brass with built in insert-supports
- Fitting bodies are SAE standard sizes
- All fitting part numbers include body, nut, ferrule, tube support, and spring guard



MC – Male Connector



Part Number	Thread Size	Hose I.D.		L		B Hex		C Hex	
		inch	mm	inch	mm	inch	mm	inch	mm
#									
MC-04-4	1/4	1/4	6	1-9/16	40	9/16	14	9/16	14
MC-06-6	3/8	3/8	10	1-13/16	46	11/16	17	13/16	21
MC-08-8	1/2	1/2	13	2-1/8	54	7/8	22	15/16	24

ML – Live Male Pipe Swivel

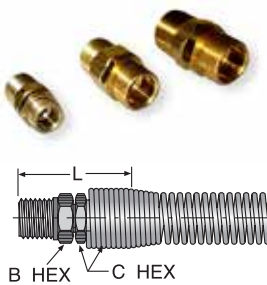

Part Number	Thread Size	Hose I.D.		L		B Hex		C Hex	
		inch	mm	inch	mm	inch	mm	inch	mm
#									
ML-04-4	1/4	1/4	6	1-9/16	40	9/16	14	9/16	14
ML-06-6	3/8	3/8	10	1-7/8	47	3/4	19	13/16	21
ML-08-8	1/2	1/2	13	2-3/8	60	5/8	22	15/16	24



WARNING

This product can expose you to chemicals including Lead, which is known to the State of California to cause cancer and birth defects or other reproductive harm. For more information go to www.P65Warnings.ca.gov.

Fast-Stor® Fittings

How to Assemble

Manufactured from heavy duty brass.



How To Assemble Fast-Stor Hose

1. Using a Parker PTC or HTC hand cutter or other sharp cutter, cut hose squarely to correct length
2. Install SG spring guard on hose as shown
3. Slide FN nut on hose followed by FR plastic ferrule with the taper side of the ferrule toward the cut end of the hose
4. Insert TS tube support
5. Push hose into fitting body until bottomed. Slide nut and ferrule up to fitting body and tighten nut by hand. With a wrench, tighten the nut an additional 2 to 2-1/2 turns
6. Slide spring guard over nut until the lead coil snaps between the nut and fitting body hex

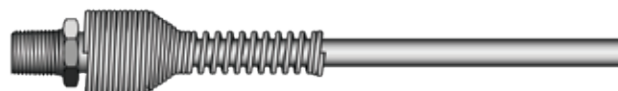
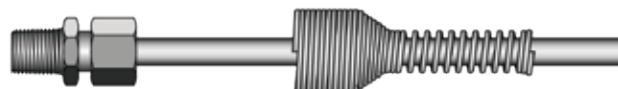

WARNING

This product can expose you to chemicals including Lead, which is known to the State of California to cause cancer and birth defects or other reproductive harm. For more information go to www.P65Warnings.ca.gov.

NoMar® Fast-Stor® Air Hose

95 Durometer Polyurethane

Excellent abrasion and kink resistance.



Features

- 95 Shore A durometer
- Constructed from non-marring, UV resistant polyurethane
- Excellent abrasion and kink resistance

Notes

- Service temperature range: -40°F (-40°C) to 180°F (82°C)
- Pigtail - 8" and 16" with NPT swivel on each end
- Pre-applied thread sealant on all fittings
- Retail packaging standard for all coils
- Extended length approximately 92% of unit length

Colors

Color Code	
● TBL	Trans. Blue
● BLK	Black
● BLU	Blue
● RED	Red
● YEL	Yellow

Order Information

Example: **95UFS-64-TBL-025**

95UFS-64-TBL-025 – Assembled Urethane Fast-Stor

95UFS-64-TBL-025 – Tube O.D. in sixteenths of an inch (**3/8"**)

95UFS-64-TBL-025 – Hose I.D. in sixteenths of an inch (**1/4"**)

95UFS-64-TBL-025 – Color **TBL = Transparent Blue**

95UFS-64-TBL-025 – Unit Length (**25'**)

Polyurethane Air Hose (Series 95UFS) Maximum Working Pressure (psig)

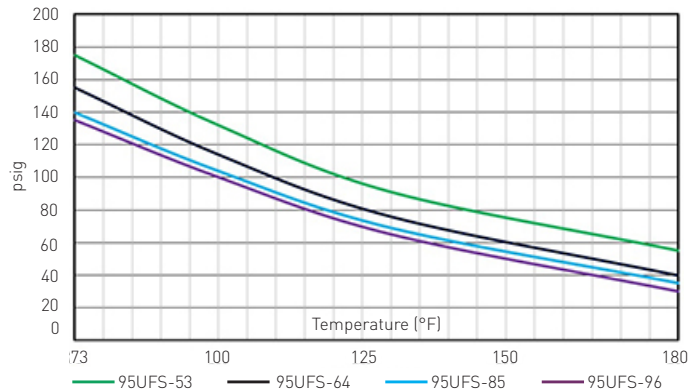

Series NoMar Fast-Stor Assemblies

Assembly Part Number	Hose O.D.		Hose I.D.		Nominal Coil O.D.		Unit Length		Extended Length		Nominal Compact Length		Working Pressure 73°F (23°C)		Minimum Burst Pressure		End Fittings	Colors
	inch	mm	inch	mm	inch	mm	ft	mtr	ft	mtr	inch	mm	psi	bar	psi	bar		
95UFS-53-XXX-010	5/16	8	3/16	5	1-5/8	41	10	3.0	9.2	2.8	7 1/2	190	175	12.1	525	36.2	1/4" NPT swivel	●
95UFS-53-XXX-025							25	7.6	23.0	7.0	21-1/2	546						●
95UFS-64-XXX-010	3/8	10	1/4	6	2-1/2	64	10	3.0	9.2	2.8	5-1/2	140	155	10.7	465	32.1	1/4" NPT swivel	●
95UFS-64-XXX-015							15	4.6	13.8	4.2	9	229						●
95UFS-64-XXX-020							20	6.1	18.4	5.6	13	330						●
95UFS-64-XXX-025							25	7.6	23.0	7.0	16	406						●
95UFS-85-XXX-010	15/32	12	5/16	8	3-3/16	81	10	3.0	9.2	2.8	5-1/2	140	140	9.7	420	29.0	3/8" NPT swivel	●
95UFS-85-XXX-015							15	4.6	13.8	4.2	8-1/2	216						●
95UFS-85-XXX-020							20	6.1	18.4	5.6	12-1/2	318						●
95UFS-85-XXX-025							25	7.6	23.0	7.0	15-1/2	394						●
95UFS-96-XXX-010	9/16	14	3/8	10	3-5/8	92	10	3.0	9.2	2.8	6	152	135	9.3	405	27.9	3/8" NPT swivel	●
95UFS-96-XXX-015							15	4.6	13.8	4.2	9-1/2	241						●
95UFS-96-XXX-020							20	6.1	18.4	5.6	13-1/2	343						●
95UFS-96-XXX-025							25	7.6	23.0	7.0	17	432						●



WARNING

This product can expose you to chemicals including Lead, which is known to the State of California to cause cancer and birth defects or other reproductive harm. For more information go to www.P65Warnings.ca.gov.

Fluoropolymer Retractable Coil Tubing

703 FEP - 704, 705 PFA

Excellent flexibility, clarity and chemical resistance.



Features

- Extremely flexible
- Excellent clarity
- Chemically inert
- Low coefficient of friction
- Self extinguishing
- Non-wetting
- Available in FEP, PFA and High Purity PFA

Compliance

- FEP - ASTM D3296
- PFA - ASTM D3307
- FDA Compliant
- USP Class VI

Colors

- ○ Natural, translucent

Notes

- Service temperature range: -100°F (-75°C) to 200°F (93°C)
For higher temperatures, request PFA -100°F (-75°C) to 300°F (148°C)
Above these temperatures, the coils dimensions are not stable and the coils will lose their shape
- Wall thickness of tubing .062"/1.57mm
- Part number nomenclature - Use prefix 703 for FEP, 704 for PFA and 705 for HP PFA
- Standard left/right tail length is 6 inches

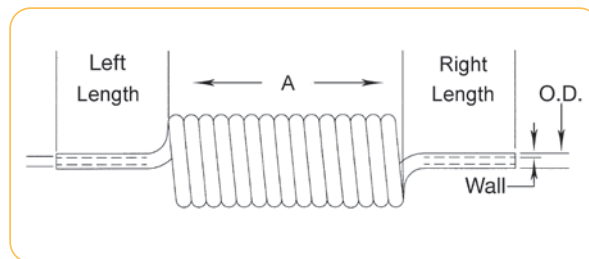

Fittings

Parker Fittings available from:
Fluid System Connectors Division
Otsego, MI

[269] 692-6555
[269] 692-6634 FAX
parker.com/fsc

For approved fittings and/or suggested use of tube supports, reference Tube/Fitting Compatibility Chart (pg. B-8/B-9) or contact Parker Fluid Systems Connectors Division

Order Information

Example: 704-0312062-xx0012

704-0312062-xx0012 – Retractable Tubing

704-0312062-xx0012 – PFA

704-0312062-xx0012 – Tube O.D. in inches (3/16")

704-0312062-xx0012 – Tube Wall Thickness in inches (.062")

704-0312062-xx0012 – Custom Options (as required)

704-0312062-xx0012 – Length in inches (12")



WARNING

This product can expose you to chemicals including Tetrafluoroethylene, which is known to the State of California to cause cancer. For more information go to www.P65Warnings.ca.gov.

Fluoropolymer Retractable Coil Tubing

Series 703 FEP

Series 703 - FEP Retractable Coil Tubing

Part Number	Tube O.D.		Tube I.D.		Nominal Coil O.D.		Extended Length		Nominal Compact Length		Working Pressure 73°F (23°C)		Colors
	inch	mm	inch	mm	inch	mm	inch	mm	inch	mm	psi	bar	
703-0250062-xx0003	1/4	6.35	1/8	3.18	1-1/2	38	12	305	3	76	375	25	○
703-0250062-xx0006							24	610	6	152			○
703-0250062-xx0012							48	1219	12	305			○
703-0250062-xx0018							72	1829	18	457			○
703-0375062-xx0003	3/8	9.68	1/4	6.35	2-3/8	60	12	305	3	76	240	16	○
703-0375062-xx0006							24	610	6	152			○
703-0375062-xx0012							48	1219	12	305			○
703-0375062-xx0018							72	1829	18	457			○
703-0500062-xx0003	1/2	12.88	3/8	9.68	4	102	12	305	3	76	175	12	○
703-0500062-xx0006							24	610	6	152			○
703-0500062-xx0012							48	1219	12	305			○

Series 704 - PFA Retractable Coil Tubing

Part Number	Tube O.D.		Tube I.D.		Nominal Coil O.D.		Extended Length		Nominal Compact Length		Working Pressure 73°F (23°C)		Colors
	inch	mm	inch	mm	inch	mm	inch	mm	inch	mm	psi	bar	
704-0250062-xx0003	1/4	6.35	1/8	3.18	1-1/2	38	12	305	3	76	375	25	○
704-0250062-xx0006							24	610	6	152			○
704-0250062-xx0012							48	1219	12	305			○
704-0250062-xx0018							72	1829	18	457			○
704-0375062-xx0003	3/8	9.68	1/4	6.35	2-3/8	60	12	305	3	76	240	16	○
704-0375062-xx0006							24	610	6	152			○
704-0375062-xx0012							48	1219	12	305			○
704-0375062-xx0018							72	1829	18	457			○
704-0500062-xx0003	1/2	12.88	3/8	9.68	4	102	12	305	3	76	175	12	○
704-0500062-xx0006							24	610	6	152			○
704-0500062-xx0012							48	1219	12	305			○

Retractable Coils FEP (Series 703)
Maximum Working Pressure (psig)

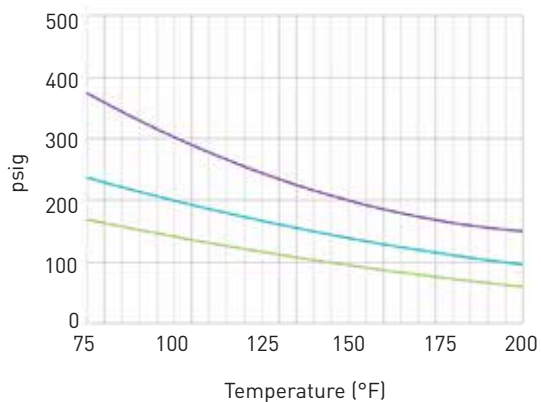

— 703-0250062 — 703-0500062
— 703-0375062

Retractable Coils PFA (Series 704)
Maximum Working Pressure (psig)

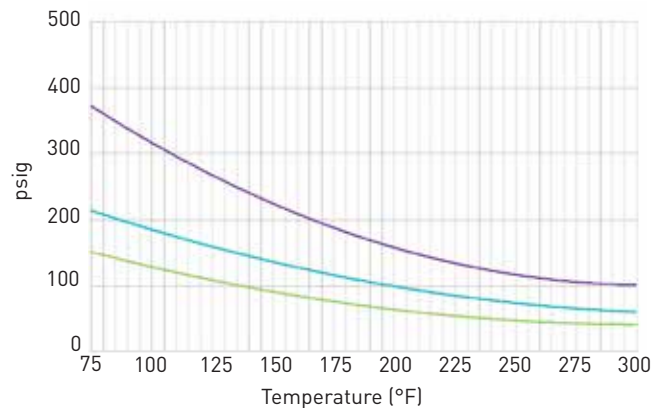

— 704-0250062 — 704-0500062
— 704-0375062



WARNING

This product can expose you to chemicals including Tetrafluoroethylene, which is known to the State of California to cause cancer. For more information go to www.P65Warnings.ca.gov.

Fluoropolymer Retractable Coil Tubing

Series 705 High Purity PFA

Series 705 - High Purity PFA Retractable Coil Tubing

Part Number	Tube O.D.		Tube I.D.		Nominal Coil O.D.		Extended Length		Nominal Compact Length		Working Pressure 73°F (23°C)		Colors
	inch	mm	inch	mm	inch	mm	inch	mm	inch	mm	psi	bar	
704-0250062-xx0003	1/4	6.35	1/8	3.18	1-1/2	38	12	305	3	76	420	28	○
704-0250062-xx0006							24	610	6	152			○
704-0250062-xx0012							48	1219	12	305			○
704-0250062-xx0018							72	1829	18	457			○
704-0375062-xx0003	3/8	9.68	1/4	6.35	2-3/8	60	12	305	3	76	200	13	○
704-0375062-xx0006							24	610	6	152			○
704-0375062-xx0012							48	1219	12	305			○
704-0375062-xx0018							72	1829	18	457			○
704-0500062-xx0003	1/2	12.88	3/8	9.68	4	102	12	305	3	76	150	10	○
704-0500062-xx0006							24	610	6	152			○
704-0500062-xx0012							48	1219	12	305			○

**Retractable Coils High Purity PFA (Series 705)
Maximum Working Pressure (psig)**

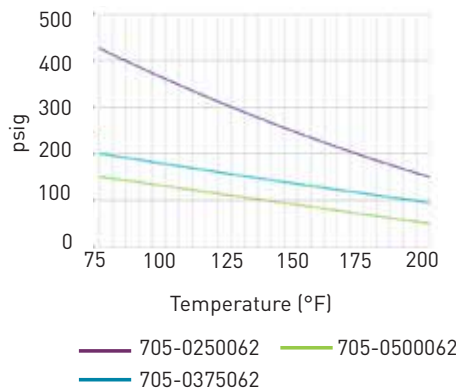

WARNING

This product can expose you to chemicals including Tetrafluoroethylene, which is known to the State of California to cause cancer. For more information go to www.P65Warnings.ca.gov.



TRANSPORTATION

Air Brake Tubing
Tractor-to-Tractor Coils

Diesel Fuel Tubing

DEF Transfer

Table of Contents

Intro

Transportation Products D-3

NOMENCLATURE D-4

Tubing

Air Brake D-5

Custom Transportation TubingD-11

Diesel Fuel D-7

Tractor-to-Trailer Coils

BrakeCoil® D-9

Fifth Wheel SliderD-10



Hose

SCR Hose for DEF Dosing SystemsD-12

Parflex Transportation Products

On-Vehicle Index

A
Hose

B
Tubing

C
Coiled Air Hose
& Fittings

D
Transportation

E
Fittings

F
Tooling,
Equipment
& Accessories

G
General
Technical

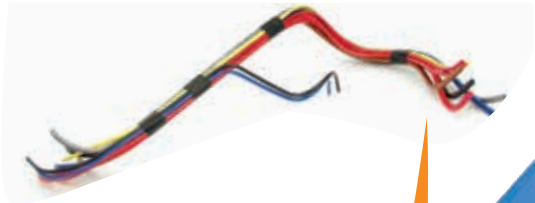

Formed Dashboard Harnesses
Transmission Air Shift Bundles
Cab Tilt Lines

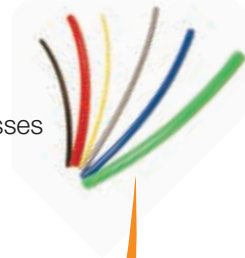

Air Brake Tubing
Air Brake Harnesses

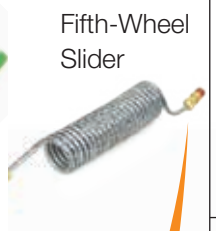

Fifth-Wheel
Slider

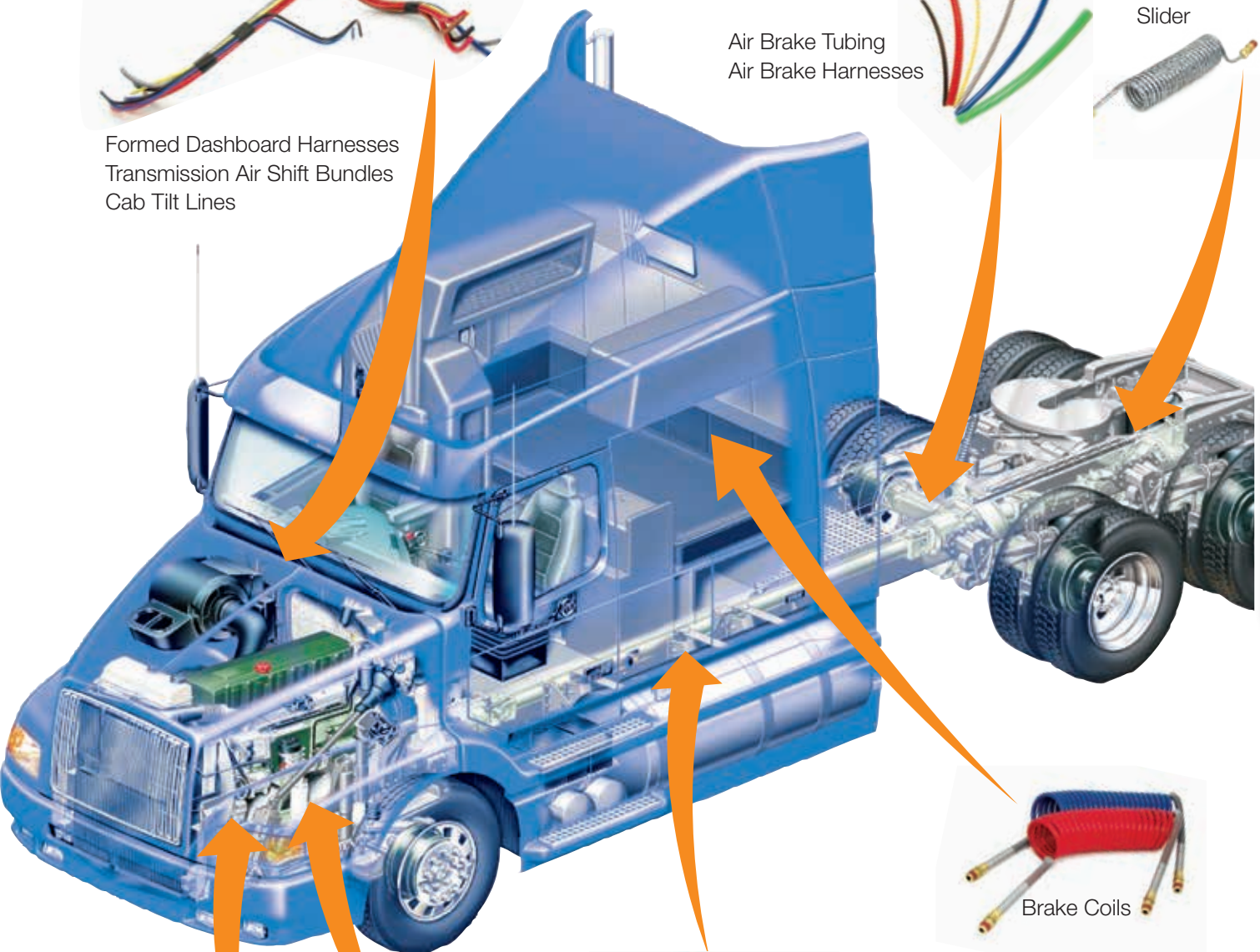

Brake Coils



Heated SCR Hose
Fuel Tubing
High Temp Fuel Lines



PTFE Hose
Compressor
Discharge
Lines



Formed Diesel Fuel
Tubing

Nomenclature Transportation Tubing

Nylon: Series Air Brake, Diesel Fuel

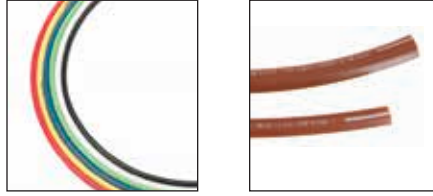

Product Family	Tube Size O.D.	Tube Type	Tubing Color*
1120 = Airbrake	2 = 0.125	A = Single-wall extruded Nylon (polyamide)	BLK = Black
PFT = Airbrake or Diesel Fuel	2.5 = 0.156	B = Nylon (polyamide) core, fiber reinforcement, Nylon (polyamide) cover/sheath	BLU = Blue
HTFL = High Temperature Diesel Fuel	3 = 0.188		BRN = Brown
	4 = 0.250		GRN = Green
	5 = 0.313		ORG = Orange
	6 = 0.375		PUR = Purple
	8 = 0.500		RED = Red
	10 = 0.625		SIL = Silver
	12 = 0.750		TAN = Tan
			YEL = Yellow
			WHT = White

Note: If color not specified in the product table, contact Parflex Division for availability

Tube Packaging	Options Designator
100 = 100 ft reel	FL = Diesel Fuel Tubing
500 = 500 ft reel	
1000 = 1000 ft reel	

Example: 1120-4A-RED-1000

1120-4A-RED-1000 – Air Brake Tubing

1120-**4A**-RED-1000 – **Tube O.D.** in sixteenths of an inch (**1/4"**)

1120-**4A**-RED-1000 – **Tube Type** Single wall

1120-4A-**RED**-1000 – **Color Red**

1120-4A-RED-**1000** – **Package Quantity** in feet (**1000'**)

The "PFT" series is used as standard for air brake tubing in -2, -2.5, -3 and -5. It is also used with Diesel Fuel Tubing (PFT-FL)

Example: PFT-6B-BLU-500-FL

PFT-6B-BLU-500-FL – Diesel Fuel Tubing*

PFT-**6B**-BLU-500-FL – **Tube O.D.** in sixteenths of an inch (**3/8"**)

PFT-**6B**-BLU-500-FL – **Tube Type** Reinforced and Jacketed

PFT-6B-**BLU**-500-FL – **Color Blue**

PFT-6B-BLU-**500**-FL – **Package Quantity** in feet (**500'**)

PFT-6B-BLU-500-**FL** – ***Designator for Diesel Fuel Tubing**

Air Brake Tubing

Series 1120, PFT

Parflex makes enough airbrake tubing every year to circle the globe twice.

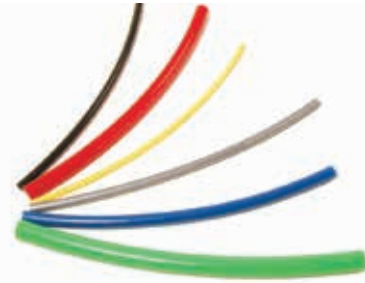

Features

- 100% pressure tested
- Excellent UV stability
- Kink resistant
- Produced from abrasion resistant, heat and light stabilized Nylon resin

Compliance

- SAE-J844
- DOT FMVSS 49CFR 571.106
- 2A, 3A, & 5A are not DOT sizes

Notes

- *2A, 3A, and 5A are not DOT sizes
- Material:
Type A – Single-wall extruded Nylon (polyamide)
Type B – Nylon (polyamide) core, fiber reinforcement, Nylon (polyamide) cover/sheath
- The operating temperature range for service at rated pressures is -40°F (-40°C) to 200°F (93°C)
- Working pressure 150 psi (10.3 bar) at 73°F (23°C)

Colors

Color Code		
●	BLK	Black
●	BLU	Blue
●	BRN	Brown
●	GRN	Green
●	ORG	Orange
●	PUR	Purple
●	RED	Red
●	SIL	Silver
●	TAN	Tan
●	YEL	Yellow
○	WHT	White

Fittings

Parker Fittings available from:
Fluid System Connectors Division
Otsego, MI

(269) 692-6555
(269) 692-6634 FAX
parker.com/fsc

For approved fittings and/or suggested use of tube supports, reference Tube/Fitting Compatibility Chart (pg. B-8/B-9) or contact Parker Fluid Systems Connectors Division

Example: 1120-6B-RED-500

1120-6B-RED-500 – Air Brake Tubing

1120-6B-RED-500 – **Tube O.D.** in sixteenths of an inch (**3/8"**)

1120-6B-RED-500 – **Tube Type** Reinforced and Jacketed

1120-6B-RED-500 – **Color Red**

1120-6B-RED-500 – **Package Quantity** in feet (**1000'**)

The "PFT" series is used as standard for air brake tubing in -2, -2.5, -3 and -5. It is also used with Diesel Fuel Tubing (PFT-FL)



WARNING

This product can expose you to chemicals including Nickel compounds, which is known to the State of California to cause cancer. For more information go to www.P65Warnings.ca.gov.

Air Brake Tubing

Series 1120, PFT

Series 1120, PFT - Airbrake Tubing

Part Number	Tube O.D.		Tube I.D.		Nominal Wall Thickness		Minimum Burst Pressure		Minimum Bend Radius		Weight		Color
	inch	mm	inch	mm	inch	mm	psi	bar	inch	mm	lbs./ft.	kg/mtr	
PFT-2A-XXX-1000*	1/8	3.2	.079	2.0	.023	0.6	1000	68.9	3/8	9.5	.003	.005	●
PFT-2.5-XXX-250	5/32	4.0	.092	2.3	.032	0.8	1200	82.7	1/2	12.5	.006	.008	●
PFT-3A-XXX-1000*	3/16	4.8	.118	3.0	.035	0.9	1200	82.7	3/4	19.0	.008	.011	●
1120-4A-XXX-1000	1/4	6.4	.170	4.3	.040	1.0	1200	82.7	1	25.5	.012	.018	● ● ● ● ● ● ● ●
PFT-5A-BLK-500*	5/16	7.9	.232	5.9	.040	1.0	1000	68.9	1-1/4	32.0	.016	.023	●
1120-6B-XXX-100	3/8	9.5	.251	6.4	.062	1.6	1400	96.5	1-1/2	38.0	.027	.040	●
1120-6B-XXX-500													● ● ● ● ● ● ● ●
1120-8B-XXX-500	1/2	12.7	.376	9.6	.062	1.6	950	65.5	2	51.0	.039	.058	● ● ● ● ● ● ● ●
1120-10B-XXX-250	5/8	15.9	.441	11.2	.092	2.3	900	62.1	2-1/2	63.5	.070	.104	● ● ● ● ● ● ● ●
1120-12B-XXX-250	3/4	19.1	.566	14.4	.092	2.3	800	55.2	3	76.0	.086	.128	● ● ● ● ● ● ● ●

Note: *2A, 3A, and 5A are not DOT sizes

Series 1120, PFT - Airbrake Tubing Pallet Quantities

Part Number	Standard Pallet	
	ft	mtr
PFT-2A	25000	7315
PFT-2.5	25000	7315
PFT-3A	25000	7315
1120-4A	25000	7315
PFT-5A	12000	3658
1120-6B	12000	3658
1120-8B	6000	1828
1120-10B	3000	914
1120-12B	3000	914



WARNING This product can expose you to chemicals including Nickel compounds, which is known to the State of California to cause cancer. For more information go to www.P65Warnings.ca.gov.

Diesel Fuel Tubing

Series PFT-FL, HTFL

Light weight tubing saves weight and installation labor in comparison to hose and hard-line tubing.



Features

- Designed for use in tractor, trailer and other mobile fuel systems
- Heat and light stabilized
- 100% pressure tested
- Light weight - saves weight and labor in comparison with hose and hard-line tubing
- HTFL for use in high temperature applications and available in pre-formed tubes for quicker installations

PFT-FL Notes

- Material: Heat and light stabilized Nylon
- Compatible with JP-5 (MIL-DTL-5624) and JP-8 (MIL-DTL-83133)
- The operating temperature range for service at rated pressures is -40°F (-40°C) to 200°F (93°C)
- Working pressure 150 psi (10.3 bar) at 73°F (23°C)
- Working pressure and burst pressure are at 73°F (23°C)

Colors

- PFT-FL ● Blue
- HTFL ● Brown

HTFL Notes

- Material: Heat and light stabilized Nylon
- Compatible with JP-5 (MIL-DTL-5624) and JP-8 (MIL-DTL-83133)
- Compatible with Biodiesel per Parflex PPB PL-18 hard-line tubing
- The operating temperature range for service at rated pressures is -50°F (-46°C) to +266°F (130°C)
- Working pressure and burst pressure are at 73°F (23°C)
- Vacuum rating at 28 inch Hg

Fittings

Parker Fittings available from:
Fluid System Connectors Division
Otsego, MI

(269) 692-6555
(269) 692-6634 FAX
parker.com/fsc

For approved fittings and/or suggested use of tube supports, reference Tube/Fitting Compatibility Chart (pg. B-8/B-9) or contact Parker Fluid Systems Connectors Division

Order Information

Example: PFT-6B-BLU-0500-FL

PFT-6B-BLU-0500-FL – Diesel Fuel Tubing*

PFT-6B-BLU-0500-FL – **Tube O.D.** in sixteenths of an inch (**3/8"**)

PFT-6B-BLU-0500-FL – **Tube Type** Reinforced and Jacketed

PFT-6B-**BLU**-0500-FL – **Color Blue**

PFT-6B-BLU-**0500**-FL – **Package Quantity** in feet (**500'**)

PFT-6B-BLU-0500-**FL** – ***Designator for Diesel Fuel Tubing**

Order Information

Example: HTFL-6B-BRN-500

HTFL-6B-BRN-500 – High Temperature Diesel Fuel Tubing

HTFL-6B-BRN-500 – **Tube O.D.** in sixteenths of an inch (**3/8"**)

HTFL-6B-BRN-500 – **Reinforced and Jacketed**

HTFL-6B-**BRN**-500 – **Color Brown**

HTFL-6B-BRN-**500** – **Package Quantity** in feet (**500'**)



WARNING

This product can expose you to chemicals including Nickel compounds, which is known to the State of California to cause cancer. For more information go to www.P65Warnings.ca.gov.

Diesel Fuel Tubing

Series PFT-FL, HTFL

Series PFT-FL - Diesel Fuel Tubing

Part Number	Nominal Tube O.D.		Nominal Tube I.D.		Nominal Wall I.D.		Working Pressure 73°F(23°C)		Minimum Burst Pressure		Minimum Bend Radius		Weight		Color
	inch	mm	inch	mm	inch	mm	psi	bar	psi	bar	inch	mm	lbs./ft.	kg/mtr	
PFT-4A-XXX-1000-FL	1/4	6.4	.170	4.3	.040	1.0	150	10.3	1200	82.7	1	25.5	.012	.018	
PFT-6B-XXX-500-FL	3/8	9.5	.251	6.4	.062	1.6	150	10.3	1400	96.5	1-1/2	38.0	.027	.040	●
PFT-8B-XXX-500-FL	1/2	12.7	.376	9.6	.062	1.6	150	10.3	950	65.5	2	51.0	.039	.058	●
PFT-10B-XXX-250-FL	5/8	15.9	.441	11.2	.092	2.3	150	10.3	900	62.1	2-1/2	63.5	.070	.104	●

Note: If color not referenced, contact the division for availability

Series HTFL - High Temperature Diesel Fuel Tubing

Part Number	Nominal Tube O.D.		Nominal Tube I.D.		Nominal Wall Thickness		Working Pressure 73°F(23°C)		Minimum Burst Pressure		Minimum Bend Radius		Weight		Color
	inch	mm	inch	mm	inch	mm	psi	bar	inch	mm	inch	mm	lbs./ft.	kg/mtr	
HTFL-6B-XXX-500	3/8	9.5	.251	6.4	.062	1.6	175	12.1	1,400	96.5	1-1/2	38.0	.028	.042	●
HTFL-8B-XXX-500	1/2	12.7	.376	9.6	.062	1.6	155	10.7	950	65.5	2	51.0	.039	.058	●
HTFL-10B-XXX-250	5/8	15.9	.441	11.2	.092	2.3	140	9.7	900	62.1	2-7/8	73.0	.071	.106	●



WARNING This product can expose you to chemicals including Nickel compounds, which is known to the State of California to cause cancer. For more information go to www.P65Warnings.ca.gov.

Tractor-to-Trailer Coils

Series BrakCoil®

Tractor-to-trailer coiled connections



Features

- BrakCoil - Tractor-to-trailer coiled nylon air-brake connections
- Maintenance-free performance - will retract to its original shape even after long periods of extended use for years of city delivery and line haul testing
- Heavy-duty plated spring guards are rust-resistant for added protection
- More coils maximize working lengths
- No need for pogo sticks or spring hangers
- Color coding gives you mistake-free hook-ups – blue for service, red for emergency

Notes

- The operating temperature range for service is -40°F (-40°C) to 200°F (93°C)
- Working pressure 150 psi (10.3 bar) at 73°F (23°C)
- Working pressure and burst pressure are at 73°F (23°C)

Compliance

- DOT FMVSS 49CFR 571.106 @ -70°F to 200°F

Colors

- Blue
- Red

Order Information

BRAKCOIL®

BRAKCOIL kits are **supplied complete** – Parker pre-assembled, with everything needed, including spring guards and male pipe NTA brass fittings, ready to install. Special pipe thread sealant is factory applied. No cutting or assembly necessary. Just attach the gladhands (sold separately or pre-assembled). They are available in kits or as separate lines. A kit consists of both a red and blue tube assembly.

Series BrakCoil - Air Brake Connection

Kit Part No.	Individual Coil Part No.	Tube O.D.		Valve Tail Length		Brass Male Ends (NPT)		Working Length		Number of Coils
		inch	mm	inch	mm	Valve inch	Gladhand inch	ft	mtr	
731516	731512-RED 731512-BLU	1/2	12.7	12	305	1/2	1/2	15	4.6	21-1/2
731522	731513-RED 731513-BLU	1/2	12.7	40	1016	1/2	1/2	15	4.6	21-1/2
741526	731612-RED 731612-BLU	1/2	12.7	40	1016	3/8	3/8	15	4.6	21-1/2
751641	741590-RED 741590-BLU	1/2	12.7	6	152	1/2	1/2	12	3.7	18-1/2

Accessories

- Extended BRAKCOIL handle available, part no. 771164
- Gladhands available
 - Blue – Part # GH9211
 - Red – Part # GH9212



WARNING

This product can expose you to chemicals including Lead, which is known to the State of California to cause cancer and birth defects or other reproductive harm. For more information go to www.P65Warnings.ca.gov.

Tractor-to-Trailer Coils

Series Fifth Wheel Slider Coil

Self-adjusts from 10" to fully extended 74" working length.



Features

- Clutter-free hook-up and maintenance-free performance of adjustable length pneumatic tubing for fifth wheel sliding action
- Self-adjusts from 10" to fully extended 74" working length
- Universal, ready for immediate installation
- Coil set is strong and permanent - Even after prolonged use in fully extended position, coils will retract to shorter length without sagging and eliminating hazards of chafing and wear

Compliance

- SAE-J844 - Type A
- DOT FMVSS 49CFR 571.106

Colors

- Silver

Notes

- Constructed with 1/4" O.D. extruded Nylon, heat and light stabilized, single wall
- The operating temperature range for service at rated pressures is -40°F (-40°C) to 200°F (93°C)
- Working pressure 150 psi (10.3 bar) at 73°F (23°C)
- Working pressure and burst pressure are at 73°F (23°C)

Series Fifth Wheel Slider

Part Number	Fittings	Pigtail Length		Maximum Extended Length		Retracted Length	
		inch	mm	inch	mm	inch	mm
811537	(2) 68NTA-4-4	2	51	74	1880	10	254



Order Information

Fifth Wheel Slider Coil

Part# 811537 comes complete with fittings.



WARNING

This product can expose you to chemicals including Lead, which is known to the State of California to cause cancer and birth defects or other reproductive harm. For more information go to www.P65Warnings.ca.gov.

Custom Transportation Tubing

Custom Harnesses, Bundles & Formed Products

<p>Formed products reduce installation times by up to 40%.</p>	
--	---

Features

- Preformed, pre-bundled tubing or hose custom designed to reduce installation timeimprove throughput with little to no tubing or hose scrap
- Individual tubes are pre-cut and assembled into a single unit

Options

- Color coding and/or numbering available for each tube
- Harnesses may contain any number of tube sizes ranging from 1/8" O.D. to 3/4" O.D.
- Harnesses can be supplied with special clamps, brackets and fittings to meet any need required by the customer
- Hoses - Contact Parflex Customer Service for custom formed hoses and hose assemblies



Cut Tubes

- Any tube offered by Parflex can be cut-to-length, with options for additional marking



Formed Tubes

- Tubes can be formed into shapes for ease of installation



Jacketed Bundles

- Two or more tubes can be bundled together with an extruded thermoplastic jacket



Harnesses

- Combine multiple cut tubes into a harness built specifically for your application



Formed Hoses

- Most Parflex thermoplastic hoses can be formed into application specific shapes

A	Hose
B	Tubing
C	Coiled Air Hose & Fittings
D	Transportation
E	Fittings
F	Tooling, Equipment & Accessories
G	General Technical

SCR Hose

Electrically Heated, On-vehicle DEF Dosing System Hose

Patented heated hose technology designed for heating and conveying DEF (Diesel Exhaust Fluid) throughout the SCR system on commercial vehicles.



Features

- Nylon and EPDM core tubes reinforced for strength and flexibility
- Helically-wrapped heating wires
- Extruded abrasion resistant jacket
- Heated fittings with protective overmolding
 - Protection against water ingress and damage of electrical components
 - Bolsters fitting strength and impact resistance
- Optional heat/abrasion shield
- 100% electrically tested, pressure tested, and cleaned before shipped
- Available in 12VDC, 24VDC, and unheated

Compliance

- IATF 16949
- ISO 14001
- IP6X, IPX8, and IPX9K

Notes

- Standard lengths available in 500 mm increments, ranging from 500 mm (0.5 m) O.A.L. through 6000 mm (6.0 m) in most configurations
- Temperature Range:
 - EPDM Temperature Range: -40°F (-40°C) to 248°F (120°C)
 - Nylon Temperature Range: -40°F (-40°C) to 248°F (120°C)



U.S. Patent No. **8,819,922**

Check www.scrhose.com for product updates



WARNING

This product can expose you to chemicals including Carbon-black extracts, which is known to the State of California to cause cancer, and Toluene, which is known to the State of California to cause birth defects or other reproductive harm. For more information go to www.P65Warnings.ca.gov.

SCR Hose

Electrically Heated, On-vehicle DEF Dosing System Hose

Series SCR - DEF Transfer Hose

Core Tube Material	I.D.		O.D.		With Heat /Abrasion Shield (optional)		Maximum Operating Pressure		Vacuum Resistance		Bend Radius	
	mm	inch	mm	inch	mm	inch	psi	bar	inch/Hg	bar	mm	inch
EPDM	4.0	.157	14.5	.571	21.0	.827	174	12.0	14.8	500	30.0	1-3/16
	5.5	.217	14.5	.571	21.0	.827	174	12.0	14.8	500	40.0	1-9/16
Nylon	6.0	.236	14.0	.551	21.0	.827	150	10.3	8.9	300	40.0	1-9/16

U.S. Patent No. **8,819,922**
 Check www.scrhose.com
 for product updates



CUSTOM OPTIONS AVAILABLE

SCR options include, but are not limited to:

- different electrical connectors, including options for heat and abrasion shield over lead wires;
- 1/4, 5/16, and 3/8 fittings; wide variety of lengths;
- 12V or 24V

Parflex also has designs for other sizes and core tubes for SCR hoses. These designs ensure that Parflex hoses can be utilized on SCR systems from multiple suppliers.

WARNING
 This product can expose you to chemicals including Carbon-black extracts, which is known to the State of California to cause cancer, and Toluene, which is known to the State of California to cause birth defects or other reproductive harm. For more information go to www.P65Warnings.ca.gov.



Fittings

Permanent/Crimp

Field Attachable



General Technical G	Tooling, Equipment & Accessories T	Fittings F	Transportation D	Coiled Air Hose & Fittings C	Tubing Thermoplastic B	Hose A
------------------------	---------------------------------------	---------------	---------------------	---------------------------------	---------------------------	-----------

Table of Contents

Introduction/Technical

Fitting Configurations	E-5
Sanitary Sizing	E-6
Pressure Rating - Fitting End Connections.....	E-8
Hose Fitting Insertion Values	E-10
Identifying Fitting Types.....	E-11
Determining Thread Type	E-12
German DIN Type.....	E-13
British Standard Pipe.....	E-14
North American Thread Types	E-15
Japanese Fittings.....	E-17
Fitting Thread Guide for Hose	E-18
Media to Fitting Compatibility.....	E-20
Metals Corrosion Scale.....	E-21

NOMENCLATURE

Fitting Nomenclature	E-4
----------------------------	-----

Field Attachable

51 Series	<i>Pending obsolescence, see 51R</i>	E-22
51R Series		E-24
90 Series		E-26
BU Series		E-31
MS Series (FA)		E-32

Permanent/Crimp

56 Series	E-33
Rapid Assembly	E-50
91/91N Series	E-51
92 Series	E-61
93N Series	E-62
94/95 Series	E-64
PAGE Fittings	E-65
CG Series	E-72
CY Series	E-77
MS Series, (permanent)	E-80
SF Series	E-81
SQ Series	E-82

A
Hose

B
Tubing

C
Coiled Air Hose
& Fittings

D
Transportation

E
Fittings

F
Tooling,
Equipment
& Accessories

G
General
Technical

Fittings

Nomenclature

Legacy Fitting Nomenclature

Example: 10356-8-6

This example describes a permanent crimp 1/2" Male JIC 37° with a 3/8" I.D. hose size. This fitting is constructed of steel since the designated material is blank.

Order Information

Example: 10356-8-6

- 10356-8-6 – **Fitting Type** (1 = Permanent/Crimp)
(2 = Field Attachable Fitting)
- 10356-8-6 – **End Configuration Code - Male JIC 37°**
- 10356-8-6 – **Fitting Series - 56 Series**
- 10356-8-6 – **End Size (1/2")**
- 10356-8-6 – **Hose I.D. (3/8")**
- 10356-8-6**C** – **Alternate Material** (C=Stainless Steel)



Legacy Fitting Material Selection

- Blank = Steel (unless otherwise noted)
- C = Stainless Steel
- S = Steel (Used only with 91N-series PTFE fittings)

NOTE: Fitting part numbers that start with a "2" are field attachable fittings.

PAGE Fitting Nomenclature

Example: 08-16SAN-S

This example describes a permanent sanitary flange step down, 1/2" I.D. hose with a 1" sanitary flange. This fitting is constructed of stainless steel since the designated material is -S.

As demonstrated below, the nomenclature associated with the PAGE fitting is not consistent with the traditional Parker products, as the end size and hose I.D. are reversed and located at the front of the part construction.



Order Information

Example: 08-16SAN-S

- 08-16SAN-S – **Hose I.D. (1/2")**
- 08-16SAN-S – **End Size (1")**
- 08-16SAN-S – **End Configuration Code - Sanitary Flange**
- 08-16SAN-**S** – **Alternate Material** (S =Stainless Steel)

PAGE Fitting Material Selection

- C = Steel
- S = Stainless Steel

NOTE: The PAGE fittings, which are designed for use with traditional PAGE fluoropolymer hoses only, are a two piece crimp connection and need to be combined with the corresponding crimp collars located on page E-48.

Fitting Configurations

by Connection and End Code

End Code	Description
Pipe	01 Male NPTF Pipe - Rigid - Straight
	13 Male NPTF Pipe - Swivel - Straight
	1L Male NPTF Pipe - Swivel - 90° Elbow
	02 Female NPTF Pipe - Rigid - Straight
	07 Female NPSM Pipe - Swivel - Straight (60° Cone)
	SAE Str. Thread
0G Male SAE Straight Thread with O-ring - Swivel - Straight	
0L Male SAE Straight Thread with O-ring - Swivel - 90° Elbow	
35 Male SAE Straight Thread with O-ring - Adjustable - 90° Elbow	
Flare	03 Male JIC 37° - Rigid - Straight
	LB Male JIC 37° - Bulkhead without Locknut - Straight
	06 Female JIC 37° - Swivel - Straight
	37 Female JIC 37° - Swivel - 45° Elbow - Short Drop
	L7 Female JIC 37° - Swivel - 45° Elbow - Medium Drop
	39 Female JIC 37° - Swivel - 90° Elbow - Short Drop
	L9 Female JIC 37° - Swivel - 90° Elbow - Medium Drop
	41 Female JIC 37° - Swivel - 90° Elbow - Long Drop
	04 Male SAE 45° - Rigid - Straight
	08 Female SAE 45° - Swivel - Straight
	77 Female SAE 45 / Swivel - 45° Elbow
	79 Female SAE 45 / Swivel - 90° Elbow
	81 Female SAE 45 / Swivel - 90° Elbow - Long Drop
	06 Female JIC 37°/SAE 45° Dual Flare - Swivel - Straight
Inverted Flare	28 Male Inverted SAE 45° - Swivel - Straight
	67 Male Inverted SAE 45° - Swivel - 45° Elbow
	69 Male Inverted SAE 45° - Swivel - 90° Elbow
	29 Female Inverted SAE 45° - Rigid - Straight
Seal-Lok	J0 Male Seal-Lok - Rigid - Straight (with O-ring)
	JB Male Seal-Lok - Bulkhead without Locknut-Straight (with O-ring)
	J5 Female Seal-Lok - Swivel - Straight - Long
	JC Female Seal-Lok - Swivel - Straight - Short
	J2 Female Seal-Lok - Swivel - 30° Elbow
	J6 Female Seal-Lok - Swivel - 22 1/2° Elbow
	J7 Female Seal-Lok - Swivel - 45° Elbow
	J9 Female Seal-Lok - Swivel - 90° Elbow - Short Drop
	J5 Female Seal-Lok - Swivel - 90° Elbow - Medium Drop
	J1 Female Seal-Lok - Swivel - 90° Elbow - Long Drop
JIS	MU Female Metric Swivel - Straight (30° Flare)
	FU Female BSP Parallel Pipe - Swivel - Straight (30° Flare)
	UT Male BSP Taper Pipe - Rigid - Straight (60° Cone)
	GU Female BSP Parallel Pipe - Swivel - Straight (60° Cone)
	G1 Female BSP Parallel Pipe - Swivel - 45° Elbow (60° Cone)
Metric	G2 Female BSP Parallel Pipe - Swivel - 90° Elbow (60° Cone)
	D0 Male Metric L - Rigid - Straight (24° Cone)
	1D Male Standpipe Metric L - Rigid - Straight

Description	End Code
Female Metric L - Swivel - Straight (Ball Nose)	C3
Female Metric L - Swivel - 45° Elbow (Ball Nose)	C4
Female Metric L - Swivel - 90° Elbow (Ball Nose)	C5
Female Metric L - Swivel - Straight (24° Cone with O-ring)	CA
Female Metric L - Swivel - 45° Elbow (24° Cone with O-ring)	CE
Female Metric L - Swivel - 90° Elbow (24° Cone with O-ring) -	CF
Male Metric S - Rigid - Straight (24° Cone)	D2
Male Standpipe Metric S - Rigid - Straight	3D
Female Metric S - Swivel - Straight (Ball Nose)	C6
Female Metric S - Swivel - 45° Elbow (Ball Nose)	C7
Female Metric S - Swivel - 90° Elbow (Ball Nose)	C8
Female Metric S - Swivel - Straight (24° Cone with O-ring)	C9
Female Metric S - Swivel - 45° Elbow (24° Cone with O-ring)	0C
Female Metric S - Swivel - 90° Elbow (24° Cone with O-ring)	1C
Male BSP Taper Pipe - Rigid - Straight	91
Female BSP Parallel Pipe - Swivel - Straight (60° Cone)	92
Male BSP Parallel Pipe - Rigid - Straight (60° Cone)	D9
Female BSP Parallel Pipe - Swivel - 45° Elbow (60° Cone)	B1
Female BSP Parallel Pipe - Swivel - 90° Elbow (60° Cone)	B2
Female BSP Parallel Pipe - Swivel - Straight (Flat Seat)	B5
Male BSP Taper Pipe - Rigid - 45° Elbow	BV
Male BSP Taper Pipe - Rigid - 90° Elbow or Side Outlet	BZ
Male Ferulok Flareless Rigid-Straight (24° Cone with Nut & Ferrule)	11
Female Ferulok Flareless - Swivel - Straight (24° Cone)	12
DIN Metric Banjo - Straight	49
ANSI B16.5 Flange	4K
Female A-Lok® Compression	AL
Female Cam & Groove	FC
Sanitary Flange & Step Downs	FN
Mini Sanitary Flange	FV
Bulkhead w/Zerk Port Integrated	GK
Male I-Line® Sanitary	H1
Female I-Line® Sanitary	H2
Male Sanitary Bevel Seat	H4
Female Sanitary Bevel Seat	H5
Male Standpipe - Rigid - Straight (Inch Size Tube O.D.)	34
Male Standpipe - Rigid - Straight with V-Notch	TW
Universal Tube Stub	TU
Male Rapid Assembly, Straight	WU
Male Rapid Assembly, 45° Elbow	WW
Male Rapid Assembly, 90° Elbow	WY

A Hose

B Tubing

C Coiled Air Hose & Fittings

D Transportation

E Fittings

F Tooling, Equipment & Accessories

G General Technical

Sanitary Sizing (PAGE Series)

Typical Dimensions

These actual size drawings are provided to eliminate sizing errors when specifying sanitary fittings. The outside diameter is the same for 1/8", 1/4", 3/8", 1/2" and the 3/4" (mini) styles. For your convenience and ordering accuracy, all of these drawings may be used as sizing I.D. and O.D. patterns. These fittings are ASME-BPE compliant.

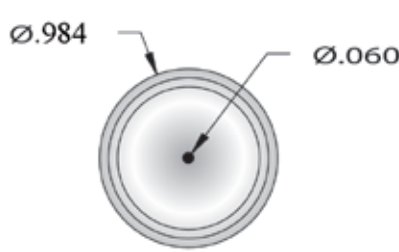

1/8" MINI T.C.

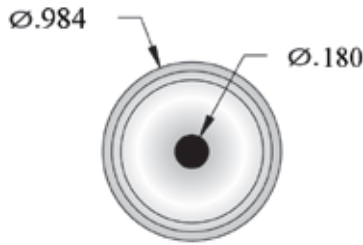

1/4" MINI T.C.

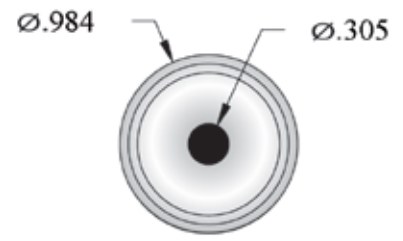

3/8" MINI T.C.

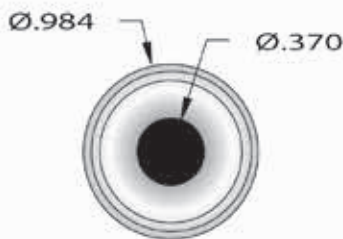

1/2" MINI T.C.

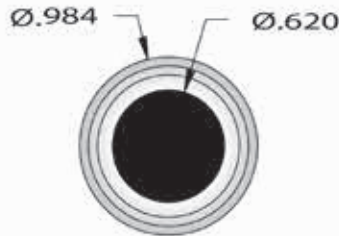

3/4" MINI T.C.

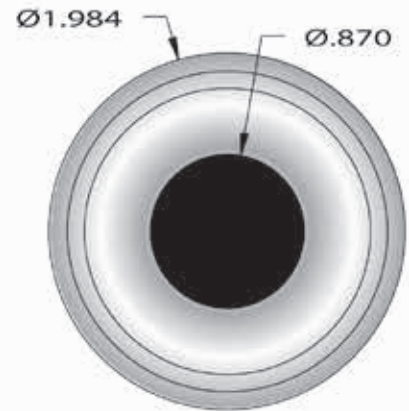

1" T.C.

(Cont.)

Sanitary Sizing (PAGE Series)

Typical Dimensions

These actual size drawings are provided to eliminate sizing errors when specifying sanitary fittings. The outside diameter is the same for 1/8", 1/4", 3/8", 1/2" and the 3/4" (mini) styles. For your convenience and ordering accuracy, all of these drawings may be used as sizing I.D. and O.D. patterns. These fittings are ASME-BPE compliant.

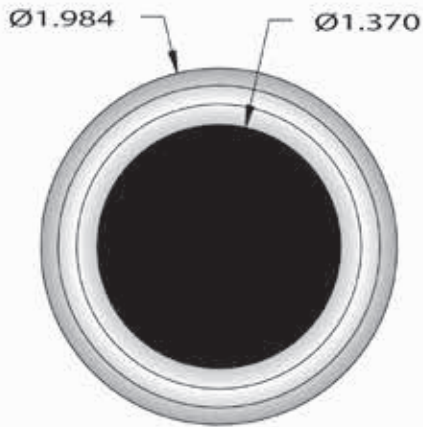

1 1/2" T.C.

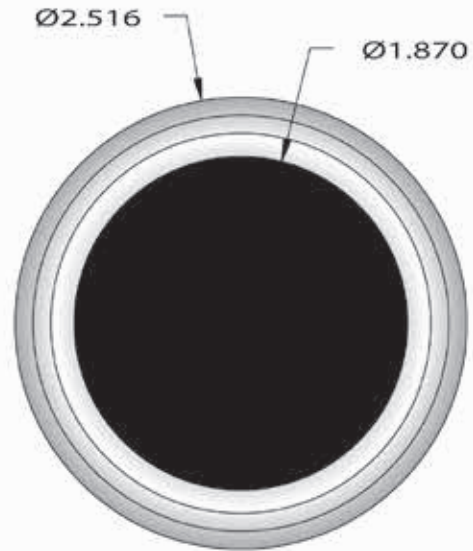

2" T.C.

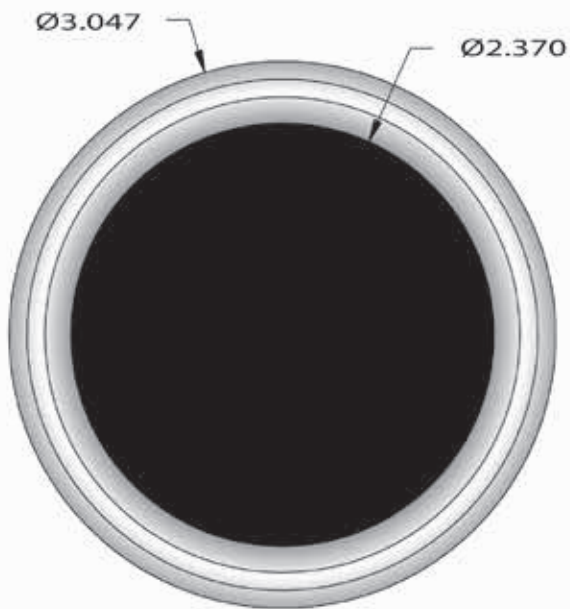

2 1/2" T.C.

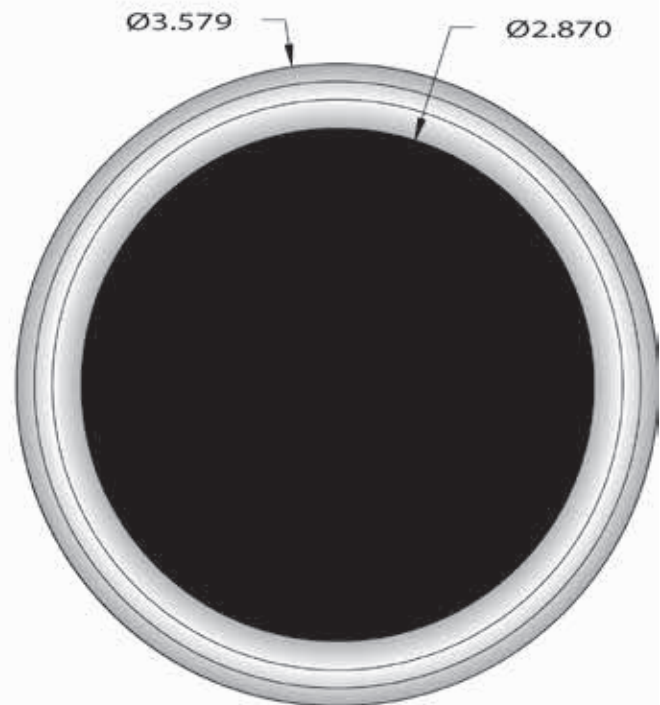

3" T.C.

A
Hose

B
Tubing

C
Coiled Air Hose
& Fittings

D
Transportation

E
Fittings

F
Tooling,
Equipment
& Accessories

G
General
Technical

Pressure Rating of Fitting End Connections

Inch Fittings

Fitting End Connection Description	Part Number Codes	Inch Fittings													
		-2	-4	-5	-6	-8	-10	-12	-16	-20	-24	-32	-40	-48	-64
		psi (MPa)	psi (MPa)	psi (MPa)	psi (MPa)	psi (MPa)	psi (MPa)	psi (MPa)	psi (MPa)	psi (MPa)	psi (MPa)	psi (MPa)	psi (MPa)	psi (MPa)	psi (MPa)
Male Pipe (NPTF)	01 & MP	12,000 (82.7)	12,000 (82.7)		10,000 (68.9)	10,000 (68.9)		7,500 (51.7)	6,500 (44.8)	5,000 (34.5)	3,000 (20.7)	2,500 (17.2)	200 (1.4)	175 (1.2)	150 (1.0)
Female Pipe (NPTF, NPSM)	02,07 & FP	7,500 (51.7)	7,000 (48.3)		6,000 (41.4)	5,000 (34.5)		4,000 (27.6)	3,000 (20.7)	2,500 (17.2)	2,000 (13.8)	2,000 (13.8)			
Male Pipe (BSP)	91 & D9	5,000 (34.5)	9,000 (62.1)		8,000 (55.2)	6,250 (43.1)		5,000 (34.5)	4,000 (27.6)	3,500 (24.1)	3,000 (20.7)	3,000 (20.7)			
Female Pipe (BSP)	92, B1, B2 & B4	5,000 (34.5)	9,000 (62.1)		8,000 (55.2)	6,250 (43.1)	5,500 (37.9)	5,000 (34.5)	4,000 (27.6)	3,500 (24.1)	3,000 (20.7)	3,000 (20.7)			
Female Pipe (JIS)	FU, GU, MU & UT		5,000 (34.5)		5,000 (34.5)	5,000 (34.5)		4,000 (27.6)	3,000 (20.7)	2,500 (17.2)	1,500 (10.3)	1,500 (10.3)			
O-Ring Swivel and 45° Flare	04, 13, 1L, S2, 0G, 0L, 48, 08, 77 & 79		3,000 (20.7)	3,000 (20.7)	3,000 (20.7)	3,000 (20.7)	2,750 (19.0)	2,250 (15.5)	2,000 (13.8)	1,625 (11.2)	1,250 (8.6)	1,125 (7.8)			
37° Flare & Straight* [2] Thread O-Ring Boss	03, 05, 06, FJX, 37, 39, 41, L7 & L9		6,000 (41.4)	6,000 (41.4)	5,000 (34.5)	5,000 (34.5)	5,000 (34.5)	5,000 (34.5)	4,000 (27.6)	3,000 (20.7)	2,500 (17.2)	2,500 (17.2)	200 (1.4)		
Cam & Groove	E, CL								250 (1.7)	250 (1.7)	250 (1.7)	250 (1.7)		175 (1.2)	150 (1.0)
SAE Flareless	11 & 12		6,000 (41.4)	6,000 (41.4)	5,600 (38.6)	5,600 (38.6)	4,200 (29.0)	4,200 (29.0)	3,500 (24.1)	3,500 (24.1)	3,000 (20.7)	3,000 (20.7)		3,000 (20.7)	3,000 (20.7)
SAE Inverted Flare	28, 67 & 69		2,750 (19.0)	2,500 (17.2)	2,250 (15.5)	2,000 (13.8)									
Seal-Lok® (O-Ring Face Seal)	JM, JC, JS, FORFS, J0, J1, J5, J7 & J9		6,000 (41.4)		6,000 (41.4)	6,000 (41.4)	6,000 (41.4)	6,000 (41.4)	6,000 (41.4)	4,000 (27.6)	4,000 (27.6)		4,000 (27.6)	4,000 (27.6)	
A-Lok®	TU, AL, PLCF & TUBE		6,000 (41.4)	6,000 (41.4)	5,600 (38.6)	5,600 (38.6)	4,200 (29.0)	4,200 (29.0)	3,500 (24.1)	3,500 (24.1)	3,000 (20.7)	3,000 (20.7)	3,500 (24.1)	3,000 (20.7)	3,000 (20.7)
Rapid Assembly* [1]	WU, WY, WW		3,000 (20.7)		3,000 (20.7)										
Sanitary Bevel Seat	FBS, MBS							400 (2.8)	400 (2.8)	400 (2.8)	400 (2.8)	400 (2.8)	200 (1.4)	175 (1.2)	150 (1.0)
ANSI B16.5 150# Flange (to 100°F)	PF, SFR					285 (2.0)		285 (2.0)	285 (2.0)	285 (2.0)	285 (2.0)	285 (2.0)	200 (1.4)	175 (1.2)	150 (1.0)
I-Line® Sanitary	FIL, MIL, MSAN, SAN	Consult Manufacturer of Seals and Clamps for Ratings													

*[1] Rapid Assembly connection has a temperature range of -40°F (-40°C) to 212°F (100°C)

*[2] .When used with 527BA hose only, Parflex -4 JIC and -4 O-ring boss fittings are rated for 7000 psi (48.3 MPa) working pressure

NOTES:

- All the above ratings are based on steel and stainless steel hose Parflex fittings.
- Parflex 106CG-16-16 / 106CG-16-16C is rated for 5000 psi (34.5 Mpa) working pressure.
- Fitting connections such as I-Line®, ANSI B16.5 Flange, Sanitary Bevel Seat, Cam and Groove, Seal-Lok® require elastomeric seals to function properly. When specifying or replacing seals, ensure the selected seal type meets the performance requirements of the application, including temperature, pressure, chemical compatibility and permeability.
- The maximum working pressure of a tube or hose assembly is the lower of the respective published maximum working pressures of the hose, tube and the fittings used.
- The maximum working pressures of hoses are listed on Page A-10 : A-17 with each hose description in Section A.

Pressure Rating of Fitting End Connections

Metric Fittings

Fitting End Connection Description	Part Number Codes	Metric Fittings															
		-6	-8	-10	-12	-14	-15	-16	-18	-20	-22	-25	-28	-30	-35	-38	-42
		psi (MPa)	psi (MPa)	psi (MPa)	psi (MPa)	psi (MPa)	psi (MPa)	psi (MPa)	psi (MPa)	psi (MPa)	psi (MPa)	psi (MPa)	psi (MPa)	psi (MPa)	psi (MPa)	psi (MPa)	psi (MPa)
DIN Light "L" without O-Ring	C3, C4, C5 & 1D	3,500 (24.1)	3,500 (24.1)	3,500 (24.1)	3,500 (24.1)		3,500 (24.1)		2,250 (15.5)		2,250 (15.5)		1,400 (9.7)		1,400 (9.7)		1,400 (9.7)
DIN Light "L" with O-Ring	D0, CA, CE & CF	4,500 (31.0)	4,500 (31.0)	4,500 (31.0)	4,500 (31.0)		4,500 (31.0)		2,250 (15.5)		2,250 (15.5)		2,250 (15.5)		2,250 (15.5)		2,250 (15.5)
DIN Heavy "S" without O-Ring	C6, C7, C8 & 3D		9,000 (62.1)	9,000 (62.1)	9,000 (62.1)	9,000 (62.1)		5,750 (39.6)		5,750 (39.6)		5,750 (39.6)		3,500 (24.1)		3,500 (24.1)	
DIN Heavy "S" with O-Ring	C9, 0C, 1C & D2		9,000 (62.1)	9,000 (62.1)	9,000 (62.1)	9,000 (62.1)		6,000 (41.4)		6,000 (41.4)		6,000 (41.4)		6,000 (41.4)		4,500 (31.0)	

NOTES:

- All the above ratings are based on steel and stainless steel hose Parflex fittings.
- Parflex 106CG-16-16 / 106CG-16-16C is rated for 5000 psi (34.5 Mpa) working pressure.
- Fitting connections such as I-Line®, ANSI B16.5 Flange, Sanitary Bevel Seat, Cam and Groove, Seal-Lok® require elastomeric seals to function properly. When specifying or replacing seals, ensure the selected seal type meets the performance requirements of the application, including temperature, pressure, chemical compatibility and permeability.
- The maximum working pressure of a tube or hose assembly is the lower of the respective published maximum working pressures of the hose, tube and the fittings used.
- The maximum working pressures of hoses are listed on Page A-10 : A-17 with each hose description in Section A.

A
Hose

B
Tubing

C
Coiled Air Hose & Fittings

D
Transportation

E
Fittings

F
Tooling, Equipment & Accessories

G
General Technical

Hose Fitting Insertion Values

Inch & Metric

A Hose

Inch

Hose Dash Size	51	51R	54	56	CG	90	91/91N	92	93N	BU	CY	MS Field Attachable	MS Permanent
-2				5/8						1/2	1/2		
-3	13/16	1-7/16	5/8	5/8	29/32		7/16	9/16		13/16	13/16		
-4	15/16	1-1/2	3/4	15/16	1-3/16	7/16	1/2						
-5	15/16		7/8	1		9/16	9/16					11/16	11/16
-6	1-5/16	1-5/8	15/16	1	1-5/16	9/16	5/8		7/16			15/16	3/4
-8	1-19/32	1-3/4	15/16	1-1/8	1-9/16	5/8	11/16		7/16				
-10				1-1/8		11/16	11/16		3/4				
-12	1-13/16			1-3/8	2-3/16	11/16	3/4		7/8				
-16	1-9/16			1-7/8	2-3/4	11/16	15/16		15/16				
-20						11/16	1		1				
-24									1-1/8				
-24									1-3/8				

B Tubing Thermoplastic

C Coiled Air Hose & Fittings

D Transportation

Metric

Hose Dash Size	51	51R	54	56	CG	90	91/91N	92	93N	BU	CY	MS Field Attachable	MS Permanent
-2				16						13	13		
-3	21	36	16	16	23		11	14		21	21		
-4	24	38	19	24	30	11	13						
-5	24		22	25		14	14					17	17
-6	33	41	24	25	33	14	16		11			24	19
-8	40	44	24	29	40	16	17		11				
-10				29		17	17		19				
-12	46			35	56	17	19		22				
-16	40			48	70	17	24		24				
-20						17	25		25				
-24									29				
-32									35				

E Fittings

F Tooling, Equipment & Accessories

G General Technical

Identifying Fitting Types

Sealing and Thread Identification

In general fittings can be identified by their visual appearance, their sealing surface/sealing type or by their thread type/form. Viewing the following pages, the visual identification will be self explanatory. The sealing mechanism and the method of thread identification, however, needs further explanation.

Determining Sealing Mechanisms

- Thread interface
- O-ring
- Matching angle or metal-to-metal joint
- Mated angle with O-ring

Thread Interface

The sealing is assured by the flattening of the edges of the threads when the male is screwed into the female fitting. Typically the front of the male fittings is narrower than the back of the fittings – often referred to as tapered threads.

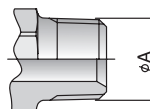

O-ring

The O-ring on the male is compressed against the corresponding female and assures the seal. This type of sealing mechanism should be the preferred choice for high-pressure applications.

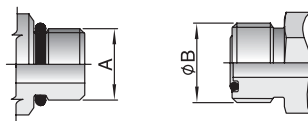

Matching Angle or Metal-to-Metal Joint

Sealing takes place where the two angled faces of the male and corresponding female meet and are wedged into one another by the tightening of the threaded nut. The sealing surfaces can either be convex or concave (seat) on the male or in the head of the pipe of the female as shown.

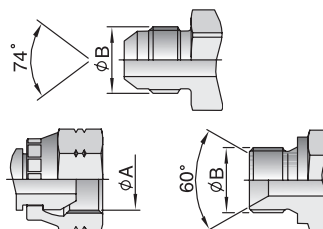

Matching Angle with O-ring

These fittings combine the functionality of both the matching angle seal with the O-ring. The O-ring is in the angled sealing surface of the fitting so that when the threaded male and female are screwed together the sealing surfaces wedge together and at the same time deform the O-ring between them.

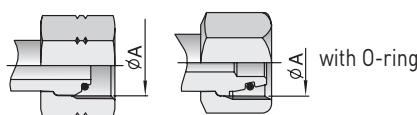

A
Hose

B
Tubing

C
Coiled Air Hose
& Fittings

D
Transportation

E
Fittings

F
Tooling,
Equipment
& Accessories

G
General
Technical

Determining Thread Type

Identifying Type

In general, the threads of various fittings look similar and hinder the easy identification of the thread. To assure the correct identification, the threads must be measured and compared to the tables listed in the following section.

Thread Gauge

Using a thread gauge, the number of threads per inch can be determined. Holding the gauge and coupling threads in front of a lighted background helps to obtain an accurate measurement.

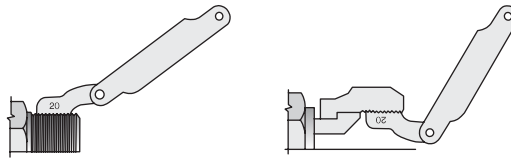

Caliper Measure

A vernier caliper should be used to measure the thread diameter of the largest point. (Outside diameter (O.D.) of male threads – Inside Diameter (I.D.) of female threads.

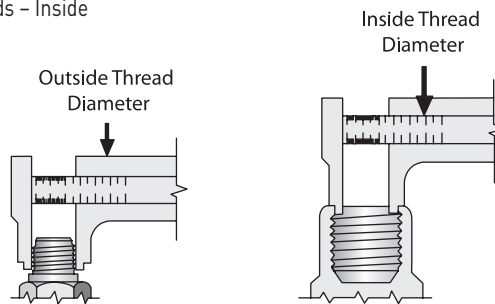

A Hose

Tubing
B Thermoplastic

C Coiled Air Hose
& Fittings

D Transportation

F Fittings

Tooling,
Equipment
T & Accessories

G General
Technical

German DIN Hose Fittings

Metric Fittings

Often referred to as metric fittings, these fittings seal using the angled sealing surfaces (metal-to-metal) or the combination of metal-to-metal with O-rings.

They are available in light (L) or heavy series (S).

The sealing face angles are either 24° with or without O-rings, or 24°/60° universal cones.

Identification is made by measuring the thread size and also the tube outside diameter.

Defined by the outside diameter and the pitch (distance between 2 crests of the thread) example: M22x1.5 - pitch of 1.5mm.

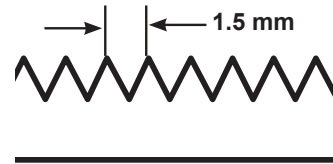

DIN Light (L) and Heavy Series (S) without O-ring

The male 24° cone will mate with the female universal 24° or 60° cone only. The male has a 60° sealing angle (seat) and straight metric threads. The female has a 24° and 60° universal seat and straight metric threads.

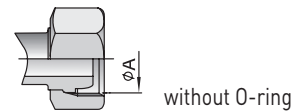

Standard

DIN 20078 Part 2¹⁾

(previously known as DIN 20078 A, D & E)

Parker end configurations light series

C3, C4, C5, C6

(Often referred to as "Ball nose cones")

1) obsolete standard, no exact replacement

DIN 24° Light (L) and Heavy Series (S) with O-ring

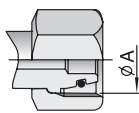

with O-ring

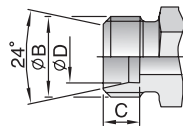

without O-ring

The male has a 24° sealing angle cone seat with straight metric threads.

The female has a 24° convex cone with O-ring and a swivel straight metric threaded nut.

Standard

ISO 12151-2 / ISO 8434-1 & ISO 8434-4

(Previously DIN 20 078 Part 4, 5, 8, 9)

Parker end configurations light series

CA, CE, CF, D0

Parker end configurations heavy series

C9, 0C, 1C, D2

Tube O.D. DN	Spec	Thread metric	ØA mm	ØB mm	C mm	ØD mm
6.00	6L	M12X1.5	10.50	12.00	7.00	6.20
6.00	6S	M14X1.5	12.50	14.00	7.00	6.20
8.00	8L	M14x1.5	12.50	14.00	7.00	8.20
8.00	8S	M16x1.5	14.50	16.00	7.00	8.20
10.00	10L	M16x1.5	14.50	16.00	7.00	10.20
10.00	10S	M18x1.5	16.50	18.00	7.50	10.20
12.00	12L	M18x1.5	16.50	18.00	7.00	12.20
12.00	12S	M20x1.5	18.50	20.00	7.50	12.20
14.00	14S	M22x1.5	20.50	22.00	8.00	14.20
15.00	15L	M22x1.5	20.50	22.00	7.00	15.20
16.00	16S	M24x1.5	22.50	24.00	8.50	16.20
18.00	18L	M26x1.5	24.50	26.00	7.50	18.20
20.00	20S	M30x2	27.90	30.00	10.50	20.20
22.00	22L	M30x2	27.90	30.00	7.50	22.20
25.00	25S	M36x2	33.90	36.00	12.00	25.20
28.00	28L	M36x2	33.90	36.00	7.50	28.20
30.00	30S	M42x2	39.90	42.00	13.50	30.20
35.00	35L	M45x2	42.90	45.00	10.50	35.30
38.00	38S	M52x2	49.90	52.00	16.00	38.30
42.00	42L	M52x2	49.90	52.00	11.00	42.30

British Standard Pipe

BSP

Also referred to as Whitworth threads, the BSP thread type fittings seal use metal-to-metal angled surfaces or a combination of metal-to-metal and an O-ring. The angle of the sealing surfaces is 60° for both forms.

There are two popular thread forms:

British Standard Pipe Parallel (BSPP) and British Standard Pipe Tapered (BSPT).

Identification is made by measuring the outside diameter of the thread and the number of threads per inch (25.4 mm)

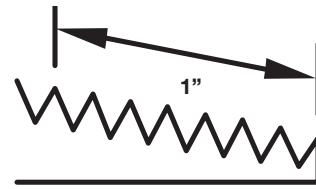

BSPP

BS5200

Parker end configurations
92, B1, B2, B4, D9

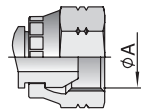

BSPP

metal-to-metal with O-ring

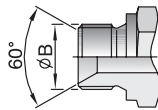

Standard
ISO 12151-6

Some Parker end configurations may be non-standard parts.

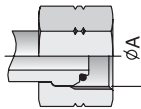

Tube I.D./O.D. inch	Size	Thread BSP	ØB mm	ØA mm
5/10	-2	1/8x28	8.60	9.70
8/13	-4	1/4x19	11.50	13.20
12/17	-6	3/8x19	14.90	16.70
15/21	-8	1/2x14	18.60	20.90
18/23	-10	5/8x14	20.60	22.90
20/27	-12	3/4x14	24.10	26.40
26/34	-16	1x11	30.30	33.20
33/42	-20	1-1/4x11	38.90	41.90
40/49	-24	1-1/2x11	44.90	47.80
50/60	-32	2x11	56.70	59.60

BSPT

BS5200

Fittings seal through the thread interface mechanism. Care should be taken not to confuse the BSPT fitting with the NPTF male fitting. BSPT has a 55° thread angle. NPTF has 60° thread angle.

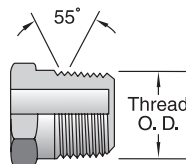

Parker end configurations
91

Tube I.D./O.D. inch	Size	Thread BSP	ØA mm
5/10	-2	1/8x28	9.73
8/13	-4	1/4x19	13.16
12/17	-6	3/8x19	16.66
15/21	-8	1/2x14	20.96
20/27	-12	3/4x14	26.44
26/34	-16	1x11	33.25
33/42	-20	1-1/4x11	41.91
40/49	-24	1-1/2x11	47.80
50/60	-32	2x11	59.61

BSP Flat Seal

These fittings have BSP parallel threads but the sealing surface is flat. The seal is made when the composite seal is compressed against the female flat face. Some Parker end configurations may be non-standard parts.

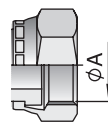

Tube I.D./O.D. inch	Size	Thread BSP	ØA mm
6/10	-2	1/8x28	8.6
8/13	-4	1/4x19	11.5
12/17	-6	3/8x19	14.9
15/21	-8	1/2x14	18.6
18/23	-10	5/8x14	20.6
20/27	-12	3/4x14	24.1
26/34	-16	1x11	30.3

North American Thread Types

This type of fitting uses the thread interface to seal and as such has a tapered thread that deforms and forms the seal. They have 30° sealing angle surfaces, forming a 60° inverted (concave) seat. The fittings are most frequently seen on machines of US origin.

Dryseal American Standard Taper Pipe Thread (NPTF)

The NPTF male will mate with the NPTF, NPSF, or NPSM females. Care should be taken not to confuse the NPTF fitting with the BSPT male fitting. NPTF fittings have a 60° thread angle. BSPT has a 55° thread angle.

Standard

SAE J516

Parker end configurations **01**

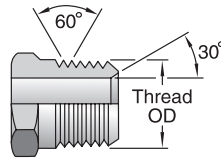

ØA dimension is measured on the pitch of the thread

Size	Thread NPTF	ØA mm	ØB mm
-2	1/8x27	10.24	8.73
-4	1/4x18	13.61	11.90
-6	3/8x18	17.05	15.90
-8	1/2x14	21.22	19.05
-12	3/4x14	26.56	24.60
-16	1x11.5	33.22	30.95
-20	1-1/4x11.5	41.98	39.69
-24	1-1/2x11.5	48.05	45.24
-32	2x11.5	60.09	57.15

SAE JIC 37°

Commonly referred to as JIC fittings, these metal-to-metal sealing type fittings have a 37° flare (sealing surface angle) and straight United National Fine Threads (UNF).

The original design specification for the fittings comes from the Society of Automotive Engineers (SAE) and these fittings are the most common American fitting types in Europe.

Standard

ISO 12151-5, ISO8434-2 and SAE J516

Parker JIC hose fittings are fully compatible with Parker Triple-Lok Tube Fittings and adapters.

Parker end configurations

03, 06, 37, 39, 41, L9

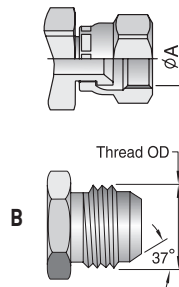

Tube I.D. inch	Tube O.D. mm	Thread UNF	Size	ØA mm	ØB mm
3/16		3/8x24	-3	8.60	9.50
1/4	6	7/16x20	-4	10.00	11.10
5/16	8	1/2x20	-5	11.60	12.70
3/8	10	9/16x18	-6	13.00	14.30
1/2	12	3/4x16	-8	17.60	19.10
5/8	14-15-16	7/8x14	-10	20.50	22.20
3/4	18-20	1-1/16x12	-12	24.60	27.00
7/8	22	1-3/16x12	-14	28.30	30.10
1	25	1-5/16x12	-16	31.30	33.30
1-1/4	30-32	1-5/8x12	-20	39.20	41.30
1-1/2	38	1-7/8x12	-24	45.60	47.60
2		2-1/2x12	x32	61.50	63.50

(Cont.)

North American Thread Types

A Hose

Tubing Thermoplastic

Coiled Air Hose & Fittings

Transportation

Fittings

Tooling, Equipment & Accessories

General Technical

SAE 45° Flare

The angle of the flare is commonly used as a name when referring to these metal-to-metal sealing fittings.

The female fittings have a 90° concave inverted seat, created by the 45° angle sealing surfaces.

The SAE 45° flare male will mate with an SAE 45° flare female only or a dual seat JIC 37°/SAE45°.

Standard
SAE J516

Parker end configurations
04, 08, 77, 79, 81

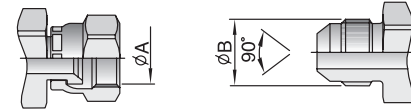

Tube I.D inch	Size	Thread UNF	Size	ØA mm	ØB mm
1/4	x4	7/16x20	9.90	11.10	9.50
5/16	-5	1/2x20	11.50	12.70	11.10
3/8	-6	5/8x18	14.30	15.90	12.70
1/2	-8	3/4x16	17.50	19.10	14.30
5/8	-10	7/8x14	20.60	22.20	19.10
3/4	-12	1-1/16x14	25.00	27.00	22.20

SAE O-ring (Boss Type)

This male fitting has straight threads, a sealing face and an O-ring. It is compatible only with female boss type fittings generally found in the ports of machines. Sealing is achieved through the O-ring of the male and through the sealing face of the female.

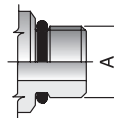

Parker end configurations
05

Thread UNF	Size	ØA mm	Thread UNF	Size	ØA mm
5/16x24	-2	7.93	1-1/16x12	-12	27.00
3/8x24	-3	9.52	1-3/16x12	-14	30.10
7/16x20	-4	11.11	1-5/16x12	-16	33.30
1/2x20	-5	12.70	1-5/8x12	-20	41.30
9/16x18	-6	14.28	1-7/8x12	-24	47.60
3/4x16	-8	19.10	2-1/2x12	-32	63.50
7/8x14	-10	22.22			

O-ring Face Seal (ORFS)

ORFS fittings are becoming the most popular international fitting type used on global OEM machines due to their high level of sealing and their good vibration resistance. The fittings use the O-ring compression mechanism to seal.

The female fittings have flat faces and straight threaded UNF swivel nuts. The male fittings have the O-ring in a groove in the flat face.

Seen as a major advantage, these fittings offer the possibility to build the hose assemblies into fixed distances/spaces, without having to move back other system components due the flat faces of the male and female fittings – the hose assembly can be slotted in.

Standard
ISO 12151-1, ISO8434-3 and SAE J516

Parker end configurations
JC, JM/J0, JS, JU, J1, J3, J5, J7, J9

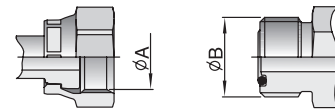

Tube I.D inch	Tube O.D. mm	Thread UNF	Size	ØA mm	ØB mm
1/4	6	9/16x18	-4	13.00	14.20
3/8	10	11/16x16	-6	15.90	17.50
1/2	12	13/16x16	-8	19.10	20.60
5/8	16	1x14	-10	23.80	25.40
3/4	20	1-3/16x12	-12	28.20	30.10
1	25	1-7/16x12	-16	34.15	36.50
1-1/4	32	1-11/16x12	-20	40.50	42.90
1-1/2	38	2x12	-24	48.80	50.80

(Cont.)

Japanese Fittings

JIS

The Japanese Industrial Standard (JIS) is seen on most Japanese equipment and uses a 30° sealing angle seat and either British Standard Pipe Parallel or metric threads. Care must be taken not to confuse the JIS fittings with BSP or JIC fittings.

Japanese Fittings - JIS

The sealing mechanism of the fittings is the 30° metal-to-metal angled surfaces.

Parker end configurations
MU, XU (Metric), FU (BSP)

JIS 30° Metric

Symbol	Thread	ØA	ØB
	metric	mm	mm
MU-6	M14x1.5	12.50	14.00
MU-9	M18x1.5	16.50	18.00
MU-12	M22x1.5	20.50	22.00
MU-15	M27x2	25.00	27.00
MU-19	M27x2	25.00	27.00
MU-25	M33x2	31.00	33.00
MU-32	M42x2	40.00	42.00
MU-38	M50x2	48.00	50.00
MU-50	M60x2	58.00	60.00

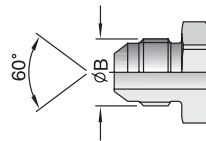

JIS 30° BSP

Symbol	Thread	ØA	ØB
	BSP	mm	mm
GUI-3	1/8x28	8.60	9.70
GUI-5/-6	1/4x19	11.50	13.20
GUI-8/-9	3/8x19	14.90	16.70
GUI-12	1/2x14	18.60	20.90
GUI-15/-19	3/4x14	24.10	26.40
GUI-25	1x11	30.30	33.20
GUI-32	1-1/4x11	38.90	41.90
GUI-38	1-1/2x11	44.90	47.80
GUI-50	2x11	56.70	59.60

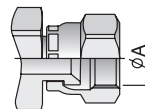

A Hose

B Tubing

C Coiled Air Hose & Fittings

D Transportation

E Fittings





F Tooling, Equipment & Accessories

G General Technical

Fitting Thread Guide For Hose

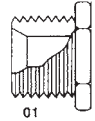
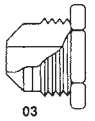
Thread Size - Inch

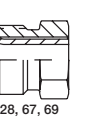
There are more than one hundred types of threads for fittings. Below are some of the most common thread styles offered by Parflex. The end code in a fitting part number is located directly after the first digit. i.e. **10356-8-8**

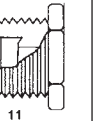
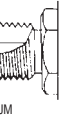



End Code								
Dash Size	NPTF Pipe Thread Size	SAE (JIC) 37° Flare Thread Size	SAE 45° Flare Thread Size	"O" Ring Style Straight Thread Size	SAE Inverted Flare Thread Size	PTT 30° Flare Thread Size	SAE Flareless Thread Size	Seal-Lok™ Thread
2	1/8 - 27	5/16 - 24	5/16 - 24	5/16 - 24	-	-	5/16 - 24	-
3	-	3/8 - 24	3/8 - 24	3/8 - 24	3/8 - 24	-	3/8 - 24	-
4	1/4 - 18	7/16 - 20	7/16 - 20	7/16 - 20	7/16 - 18	-	7/16 - 20	9/16 - 18
5	-	1/2 - 20	1/2 - 20	1/2 - 20	1/2 - 20	-	1/2 - 20	-
6	3/8 - 18	9/16 - 18	5/8 - 18	9/16 - 18	5/8 - 18	-	9/16 - 18	11/16 - 16
8	1/2 - 14	3/4 - 16	3/4 - 16	3/4 - 16	3/4 - 18	-	3/4 - 16	13/16 - 16
10	-	7/8 - 14	7/8 - 14	7/8 - 14	7/8 - 18	-	7/8 - 14	1 - 14
12	3/4 - 14	1 1/16 - 12	1 1/16 - 14	1 1/16 - 12	1 1/16 - 16	-	1 1/16 - 12	1 3/16 - 12
14	-	1 3/16 - 12	-	1 3/16 - 12	-	-	1 3/16 - 12	-
16	1 - 11 1/2	1 5/16 - 12	-	1 5/16 - 12	-	1 5/16 - 14	1 5/16 - 12	1 7/16 - 12
20	1 1/4 - 11 1/2	1 5/8 - 12	-	1 5/8 - 12	-	1 5/8 - 14	1 5/8 - 12	-
24	1 1/2 - 11 1/2	1 7/8 - 12	-	1 7/8 - 12	-	1 7/8 - 14	1 7/8 - 12	-
32	2 - 11 1/2	2 1/2 - 12	-	2 1/2 - 12	-	2 1/2 - 12	2 1/2 - 12	-

(Cont.)

Fitting Thread Guide For Hose

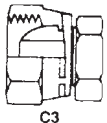
Thread Size - Metric

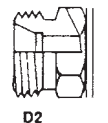
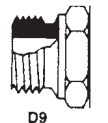
There are more than one hundred types of threads for fittings. Below are some of the most common thread styles offered by Parflex. The end code in a fitting part number is located directly after the first digit. i.e. **1C356-10-6**

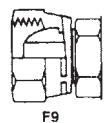
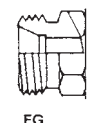
End Code									
Dash Size	Metric Swivel Female Thread Size	Metric Swivel Female Thread Size	Male Stud Thread Size	Male Stud Thread Size	Male BSPP Thread Size	BSP Swivel Female Thread Size	French Swivel Female Gas Series	French Swivel Female Metric Series	French Male Stud Gas Series
4	-	-	-	-	1/4"	1/4"	-	-	-
6	M12 x 1,5	-	M12 x 1,5	-	3/8"	3/8"	-	M12 x 1	-
8	M14 x 1,5	M16 x 1,5	M14 x 1,5	M16 x 1,5	1/2"	1/2"	-	M14 x 1,5	-
10	M16 x 1,5	M18 x 1,5	M16 x 1,5	M18 x 1,5	-	5/8"	-	M16 x 1,5	-
12	M18 x 1,5	M20 x 1,5	M18 x 1,5	M20 x 1,5	3/4"	3/4"	-	M18 x 1,5	-
-	-	-	-	-	-	-	M20 x 1,5	-	M20 x 1,5
14	-	M22 x 1,5	-	M22 x 1,5	-	-	-	M20 x 1,5	-
15	M22 x 1,5	-	M22 x 1,5	-	-	-	-	M22 x 1,5	-
16	-	M24 x 1,5	-	M24 x 1,5	1"	1"	-	M24 x 1,5	-
-	-	-	-	-	-	-	M24 x 1,5	-	M24 x 1,5
18	M26 x 1,5	-	M26 x 1,5	-	-	-	-	M27 x 1,5	-
20	-	M30 x 2	-	M30 x 2	-	-	-	M27 x 1,5	-
-	-	-	-	-	-	-	M30 x 1,5	-	M30 x 1,5
22	M30 x 2	-	M30 x 2	-	-	-	-	M30 x 1,5	-
25	-	M36 x 2	-	M36 x 2	-	-	-	M33 x 1,5	-
-	-	-	-	-	-	-	M36 x 1,5	-	M36 x 1,5
28	M36 x 2	-	M36 x 2	-	-	-	-	-	-
30	-	M42 x 2	-	M42 x 2	-	-	-	M39 x 1,5	-
33	-	-	-	-	-	-	M45 x 1,5	-	M45 x 1,5

A
Hose

B
Tubing

C
Coiled Air Hose
& Fittings

D
Transportation

E
Fittings

F
Tooling,
Equipment
& Accessories

G
General
Technical

Media to Fitting Compatibility

A Hose

B Tubing
Thermoplastic

C Coiled Air Hose
& Fittings

D Transportation

E Fittings

F Tooling,
Equipment
& Accessories

G General
Technical

Media	Fitting Material		
	Brass	Steel	316 SS
Acetylene	NR	F	S
Air (oil free) @ 190° F	S	F	S
Air (oil free) @ 300° F	S	F	S
Air (oil free) @ 400° F	S	F	S
Alcohol, Ethyl	S	NR	NR
Animal Oils (Lard Oil)	F	F	F
Aromatic Fuel - 50%	ID	ID	ID
Aromatic Solvents	ID	ID	F
Asphalt	NR	NR	S
ASTM Oil #1	S	S	S
ASTM Oil #2	S	S	S
ASTM Oil #3	S	S	S
ASTM Oil #4	S	S	S
ATF Oil	S	S	S
Automotive Brake Fluid	ID	ID	ID
Benzene	NR	F	NR
Brine (Sodium Chloride)	NR	NR	S
Butane	NR	S	S
Carbon Dioxide	S	F	S
Carbon Monoxide	S	S	S
Chlorine (Dry)	F	F	NR
Compressed Air	S	F	S
Crude Oil	NR	F	S
Cutting Oil	ID	S	S
Diesel Fuel	S	S	S
Ethanol	S	NR	NR
Ethers	S	S	S
Freon 11	S	ID	ID
Freon 12	S	S	NR
Freon 22	S	NR	S
Fuel Oil	NR	S	S
Gasoline	S	F	S
Gas, Liquid Propane (LPG)	S	S	S
Gas, Natural	F	S	S
Helium	S	S	S
Hydraulic Oil, Petroleum Base	S	S	S
Hydraulic Oil, Water Base	ID	S	S
Hydrogen Gas	S	S	S
Jet Fuel	S	S	S

Media	Fitting Material		
	Brass	Steel	316 SS
Kerosene	S	S	S
Lubricating Oil SAE 10, 20, 30, 40, 50	S	S	S
Methanol	S	S	S
MIL-F-8192 (JP-9)	S	S	S
MIL-H-5606	S	S	S
MIL-H-6083	S	S	S
MIL-H-7083	S	S	S
MIL-H-8446 (MLO-8515)	F	S	S
Mil-L-2104 & 2104B	S	S	S
MIL-L-7808	NR	F	S
Mineral Oil	S	S	S
Nitrogen	S	S	S
Petrolatum	S	S	S
Petroleum Oil (<250° F)	S	S	S
Propane	S	S	S
R134A	S	S	S
Sea Water	F	NR	S
Skydrol 500, Type 2	NR	S	S
Skydrol 7000, Type 2	NR	S	S
Soap Solutions	NR	NR	S
Steam (<400° F)	F	S	S
Stoddard Solvent	F	S	S
Transmission Fluid (Type A)	S	S	S
Trichloroethane	ID	F	S
Water	S	F	S

Rating Codes:

- S = Satisfactory
- F = Fair
- NR = Not recommended
- ID = Insufficient data

Metals Corrosion Scale

Electromotive or Galvanic Series for Metals

The susceptibility of different base metals to corrosion while in contact depends upon the difference between the contact potentials or the electromotive voltages of the metals involved. The greater the potential difference is, the greater is the tendency for corrosion. The metal with the higher potential forms the anode and is corroded. The larger the separation distance in the electromotive chart between the two metals in contact, the higher the contact potential and chances for corrosion. For example, zinc and aluminum are very short distance apart in the chart; therefore potential for corrosion when these two metals are in contact is very low. On the other hand, aluminum and passivated 316 stainless steel are far apart; hence, when in contact, the potential for corrosion is very high. Aluminum, being more anodic metal, will corrode in this combination.

As a general guideline, if the metals are half the length of the chart or more apart, the combination should be avoided. Also, it is not a good idea to combine an anodic metal part with thin cross section, such as thin wall tubing, with a cathodic or less anodic metal part of a heavy cross section, such as a fitting.

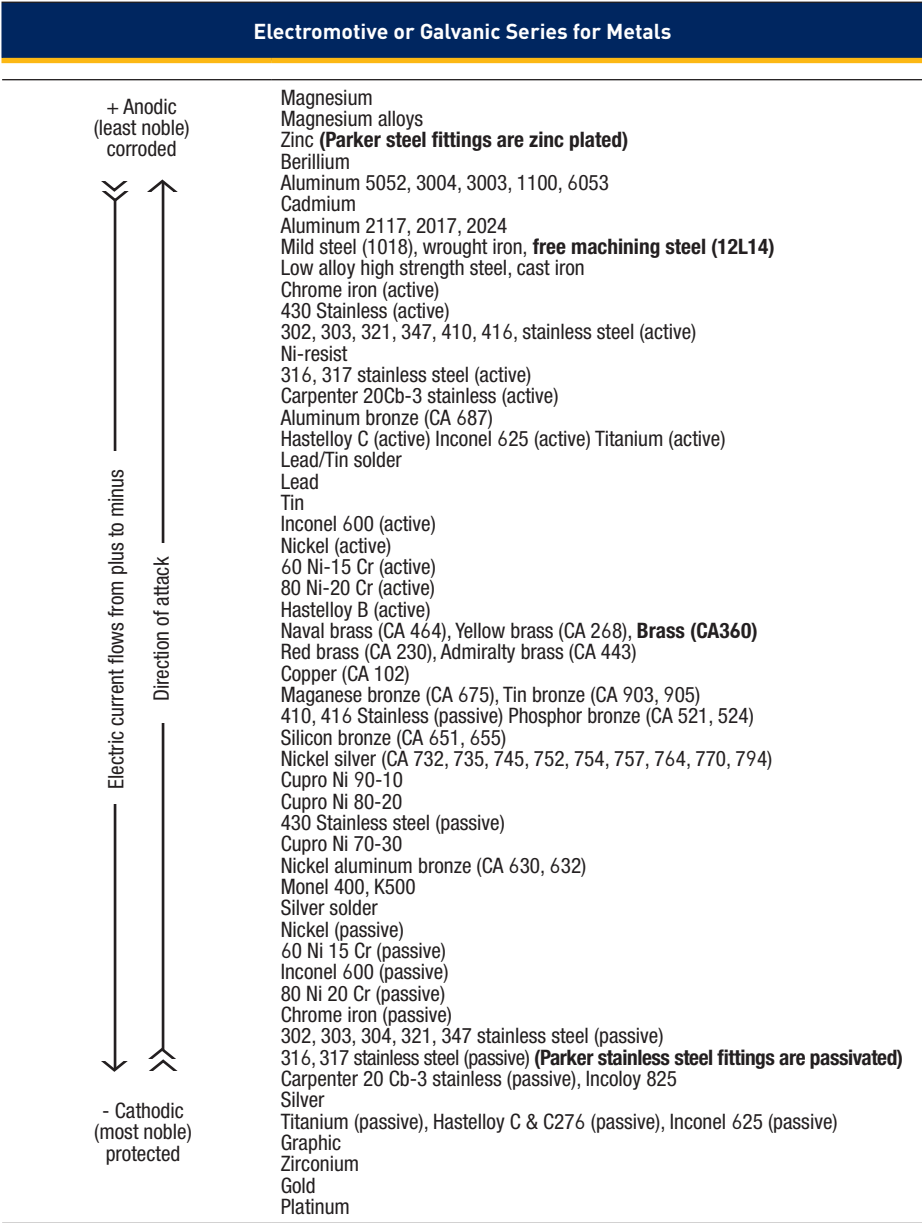

Hose	A
Tubing	B
Coiled Air Hose & Fittings	C
Transportation	D
Fittings	E
Tooling, Equipment & Accessories	F
General Technical	G

Fittings - Field Attachable

51 Series

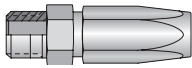
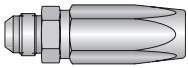
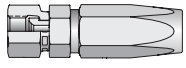
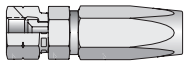
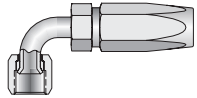
51 Series	201 Male Taper Pipe Rigid	203 Male (JIC) 37° Rigid	206 SAE (JIC) 37° Swivel	208 SAE 45° Swivel	239 JIC 37° Swivel 90° Elbow Short Drop
Field Attachable					
	E-22	E-22	E-23	E-23	E-23

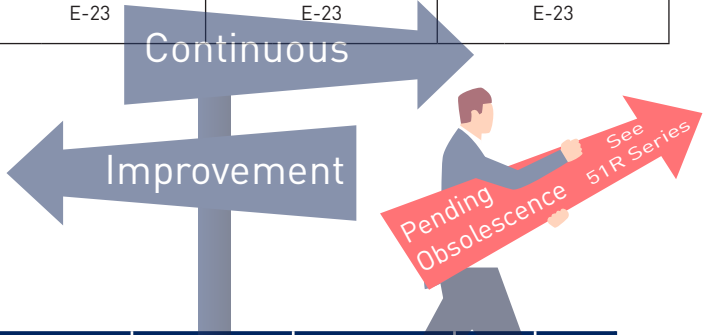

20151 Male Taper Pipe Rigid

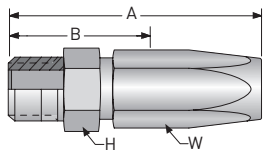

Construction: Steel.

Part Number	Thread Size	Hose I.D.		A		Cutoff Allow. B		H Hex inch	W Hex inch
		inch	mm	inch	mm	inch	mm		
20151-2-3	1/8-27	3/16	5	1.71	43	1	25	7/16	5/8
20151-4-3	1/4-18	3/16	5	1.90	48	1-1/8	29	9/16	5/8
20151-2-4	1/8-27	1/4	6	1.90	48	1	25	1/2	5/8
20151-4-4	1/4-18	1/4	6	2.08	53	1-3/16	30	9/16	5/8
20151-4-5	1/4-18	5/16	8	2.17	55	1-7/16	37	9/16	3/4
20151-6-5	3/8-18	5/16	8	2.17	55	1-7/16	37	3/4	3/4
20151-4-6	1/4-18	3/8	10	2.61	66	1-7/16	37	3/4	7/8
20151-6-6	3/8-18	3/8	10	2.61	66	1-7/16	37	3/4	7/8
20151-8-6	1/2-14	3/8	10	2.80	71	1-9/16	40	7/8	7/8
20151-6-8	3/8-18	1/2	13	2.99	76	1-1/2	38	7/8	1-1/16
20151-8-8	1/2-14	1/2	13	3.17	81	1-11/16	43	7/8	1-1/16
20151-12-12	3/4-14	3/4	19	3.42	87	1-3/4	44	1-1/8	1-3/8
20151-16-16	1-11-1/2	1	25	3.74	95	2-1/4	57	1-3/8	1-9/16

20351 Male (JIC) 37° Rigid

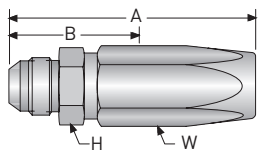

Construction: Steel.

Part Number	Thread Size	Hose I.D.		A		Cutoff Allow. B		H Hex inch	W Hex inch
		inch	mm	inch	mm	inch	mm		
20351-4-3	7/16-20	3/16	5	1.88	48	1-1/8	29	1/2	5/8
20351-5-4	1/2-20	1/4	6	2.06	52	1-1/8	29	9/16	5/8
20351-6-5	9/16-18	5/16	8	2.16	55	1-5/16	33	5/8	3/4
20351-6-6	9/16-18	3/8	10	2.61	66	1-7/16	37	3/4	7/8
20351-8-6	3/4-16	3/8	10	2.71	69	1-7/16	37	13/16	7/8
20351-8-8	3/4-16	1/2	13	3.08	78	1-5/8	41	7/8	1-1/16

WARNING This product can expose you to chemicals including Lead, which is known to the State of California to cause cancer and birth defects or other reproductive harm. For more information go to www.P65Warnings.ca.gov.

Fittings - Field Attachable

51 Series

20651 SAE (JIC) 37° Swivel

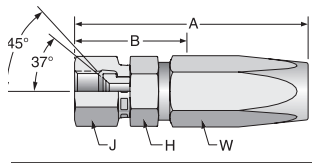

Construction: Steel.

Part Number	Thread Size	Hose I.D.		A		Cutoff Allow. B		H Hex	J Hex	W Hex
		inch	mm	inch	mm	inch	mm	inch	inch	inch
20651-4-3	7/16-20	3/16	5	1.99	51	1-1/4	32	9/16	9/16	5/8
20651-4-4	7/16-20	1/4	6	2.18	55	1-1/4	32	9/16	9/16	5/8
20651-5-4	1/2-20	1/4	6	2.24	57	1-7/16	37	5/8	5/8	5/8
20651-6-4	9/16-18	1/4	6	2.34	59	1-7/16	37	11/16	11/16	5/8
20651-6-5	9/16-18	5/16	8	2.37	60	1-1/2	38	11/16	11/16	3/4
20651-6-6	9/16-18	3/8	10	2.74	70	1-7/16	37	11/16	11/16	7/8
20651-8-6	3/4-16	3/8	10	2.88	73	1-5/8	41	7/8	7/8	7/8
20651-8-8	3/4-16	1/2	13	3.25	83	1-3/4	44	7/8	7/8	1-1/16
20651-10-8	7/8-14	1/2	13	3.37	86	1-7/8	48	1	1	1-1/16
20651-12-12	1-1/16-12	3/4	19	3.75	95	2-1/8	54	1-1/4	1-1/4	1-3/8
20651-16-16	1-5/16-12	1	25	3.87	98	2-1/4	57	1-1/2	1-1/2	1-9/16

NOTE: Sizes -4, -5, -8 and -10 incorporate a dual seat.

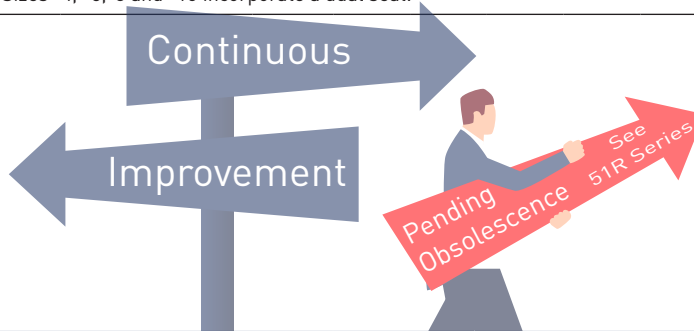

20851 SAE 45° Swivel

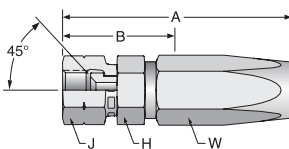

Construction: Steel.

Part Number	Thread Size	Hose I.D.		A		Cutoff Allow. B		H Hex	J Hex	W Hex
		inch	mm	inch	mm	inch	mm	inch	inch	inch
20851-6-6	5/8-18	3/8	10	2.82	72	1-9/16	40	3/4	3/4	7/8

23951 JIC 37° Swivel 90° Elbow Short Drop

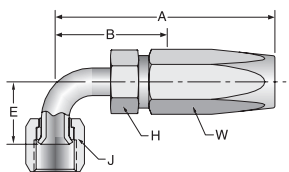

Construction: Steel.

Part Number	Thread Size	Hose I.D.		A		Cutoff Allow. B		H Hex	J Hex	W Hex
		inch	mm	inch	mm	inch	mm	inch	inch	inch
23951-4-3	7/16-20	3/16	5	1.77	45	1	25	0.83	21	3/8
23951-6-6	9/16-18	3/8	10	2.70	69	1-7/16	37	0.85	22	9/16
23951-8-6	3/4-16	3/8	10	2.90	74	1-5/8	41	1.09	28	11/16





WARNING

This product can expose you to chemicals including Lead, which is known to the State of California to cause cancer and birth defects or other reproductive harm. For more information go to www.P65Warnings.ca.gov.

Fittings - Field Attachable

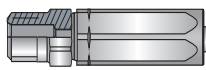
51R Series

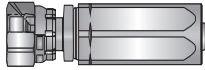
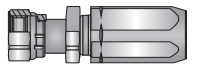
51R Series	201 Male Taper Pipe Rigid	203 Male (JIC) 37° Rigid	206 Female SAE (JIC) 37° Swivel	2JS Female Seal-Lok Swivel Straight Lg.
Field Attachable				
	E-24	E-24	E-25	E-25

20151R Male Taper Pipe Rigid

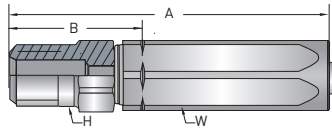

Construction: Steel.

Part Number	Thread Size	Hose I.D.		A		Cutoff Allow. B		H Hex inch	W Hex inch
		inch	mm	inch	mm	inch	mm		
20151R-4-3	1/4-18	3/16	5	2.59	66	1-1/8	29	9/16	5/8
20151R-4-4	1/4-18	1/4	6	2.67	68	1-1/8	29	9/16	5/8
20151R-6-6	3/8-18	3/8	10	2.90	74	1-5/16	33	3/4	7/8
20151R-8-8	1/2-14	1/2	13	3.32	84	1-1/2	39	7/8	1-1/16

20351R Male (JIC) 37° Rigid

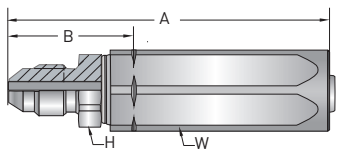

Construction: Steel.

Part Number	Thread Size	Hose I.D.		A		Cutoff Allow. B		H Hex inch	W Hex inch
		inch	mm	inch	mm	inch	mm		
20351R-4-3	7/16-20	3/16	5	2.54	65	1-1/8	29	1/2	5/8
20351R-4-4	7/16-20	1/4	6	2.63	67	1-1/8	29	1/2	5/8
20351R-6-6	9/16-18	3/8	10	2.61	66	1-7/16	37	3/4	7/8
20351R-8-8	3/4-16	1/2	13	3.08	78	1-5/8	41	7/8	1-1/16

WARNING This product can expose you to chemicals including Lead, which is known to the State of California to cause cancer and birth defects or other reproductive harm. For more information go to www.P65Warnings.ca.gov.

Fittings - Field Attachable

51R Series

20651R SAE (JIC) 37° Swivel

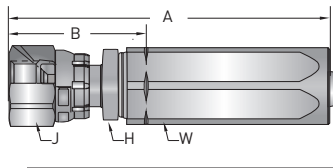

Construction: Steel.

Part Number	Thread Size	Hose I.D.		A		Cutoff Allow. B		H Hex	J Hex	W Hex
		inch	mm	inch	mm	inch	mm	inch	inch	inch
20651R-4-3	7/16-20	3/16	5	2.56	65	1-1/8	29	9/16	9/16	5/8
20651R-4-4	7/16-20	1/4	6	2.65	67	1-1/8	29	9/16	9/16	5/8
20651R-6-6	9/16-18	3/8	10	2.93	75	1-5/16	33	11/16	11/16	7/8
20651R-8-8	3/4-16	1/2	13	3.30	84	1-1/2	39	7/8	7/8	1-1/16

2JS51R Female Seal-Lok - Swivel - Straight - Long

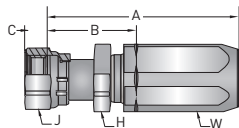

Construction: Steel.



Part Number	Thread Size	Hose I.D.		A		Cutoff Allow. B		H Hex	J Hex	W Hex
		inch	mm	inch	mm	inch	mm	inch	inch	inch
2JS51R-6-6	9/16-18	3/8	10	2.83	72	1-1/4	32	13/16	13/16	7/8
2JS51R-8-8	3/4-16	1/2	13	3.13	80	1-3/8	35	15/16	15/16	1-1/16

NOTE: When measuring overall length to the end of the nut, B+C dimensions must be used to calculate cut-off allowance.

WARNING This product can expose you to chemicals including Lead, which is known to the State of California to cause cancer and birth defects or other reproductive harm. For more information go to www.P65Warnings.ca.gov.

Fittings - Field Attachable

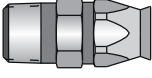
90 Series

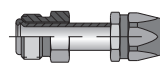
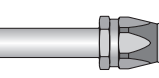
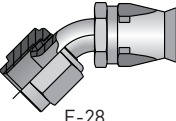
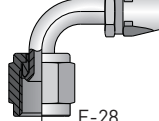
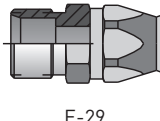
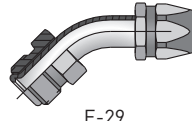
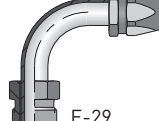
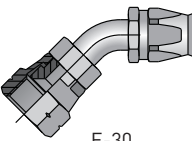
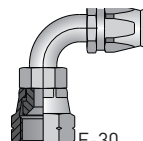
90 Series Field Attachable	201	Male Taper Pipe Rigid	206	SAE (JIC) 37° Swivel	208	SAE 45° Swivel	228	SAE Male Inverted Swivel Straight	234	Straight Tube
		E-26		E-27		E-27		E-27		E-28
	237	JIC 37° Swivel 45° Elbow	239	JIC 37° Swivel 90° Elbow Short	261	SAE Compression Air Brake	267	SAE Male Inverted Swivel 45° Elbow	269	SAE Male Inverted Swivel 90° Elbow
		E-28		E-28		E-29		E-29		E-29
	277	SAE 45° Swivel 45° Elbow	279	SAE 45° Swivel 90° Elbow						
		E-30		E-30						

20190 Male Taper Pipe Rigid

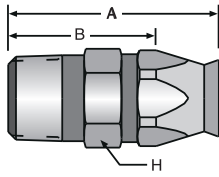

Construction: Brass nipple and ferrule, steel socket. Add "C" for Stainless Steel.

Part Number	Thread Size	Hose Size	A		Cutoff Allow. B		H Hex inch
			inch	mm	inch	mm	
20190-2-4	1/8-27	-4	1.33	34	7/8	22	9/16
20190-4-4	1/4-18	-4	1.58	40	1-1/16	27	9/16
20190-4-5	1/4-18	-5	1.66	42	1-1/8	29	5/8
20190-4-6	1/4-18	-6	1.66	42	1-1/8	29	11/16
20190-6-6	3/8-18	-6	1.66	42	1-1/8	29	11/16
20190-6-8	3/8-18	-8	1.77	45	1-3/16	30	7/8
20190-8-8	1/2-14	-8	1.97	50	1-7/16	37	7/8
20190-8-10	1/2-14	-10	2.13	54	1-7/16	37	1
20190-12-12	3/4-14	-12	2.26	57	1-9/16	40	1-1/8
20190-12-16	3/4-14	-16	2.29	58	1-5/8	41	1-3/8
20190-16-16	1-11-1/2	-16	2.46	62	1-7/8	48	1-3/8
20190-20-20	1-1/4-11-1/2	-20	2.69	68	2-1/6	52	2



WARNING

This product can expose you to chemicals including Lead, which is known to the State of California to cause cancer and birth defects or other reproductive harm. For more information go to www.P65Warnings.ca.gov.

Fittings - Field Attachable

90 Series

20690 SAE (JIC) 37° Swivel

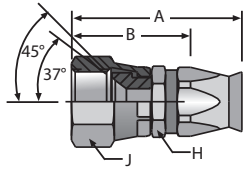

Construction: Brass nipple and ferrule, steel socket. Add "C" for Stainless Steel.

Part Number	Thread Size	Hose Size	A		Cutoff Allow. B		H Hex inch	J Hex inch
			inch	mm	inch	mm		
20690-4-4	7/16-20	-4	1.58	40	1-1/8	29	9/16	9/16
20690-5-5	1/2-20	-5	1.66	42	1-1/8	29	5/8	5/8
20690-6-6	9/16-18	-6	1.74	44	1-3/16	35	11/16	11/16
20690-8-6	3/4-16	-6	1.85	47	1-5/16	33	7/8	7/8
20690-8-8	3/4-16	-8	1.98	50	1-3/8	35	7/8	7/8
20690-8-10	3/4-16	-10	2.07	53	1-7/16	37	1	7/8
20690-10-10	7/8-14	-10	2.22	56	1-1/2	38	1	1
20690-12-12	1-1/16-12	-12	2.33	59	1-5/8	41	1-1/4	1-1/4
20690-16-16	1-5/16-12	-16	2.52	64	1-15/16	49	1-3/8	1-1/2
20690-20-20	1-5/8-12	-20	2.99	76	2-5/16	59	2	2

NOTE: Sizes -4, -5, -8 and -10 incorporate a dual seat.

20890 SAE 45° Swivel

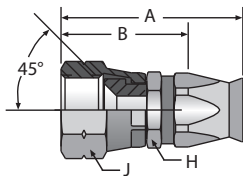

Construction: Brass nipple and ferrule, steel socket. Add "C" for Stainless Steel.

Part Number	Thread Size	Hose Size	A		Cutoff Allow. B		H Hex inch	J Hex inch
			inch	mm	inch	mm		
20890-6-6	5/8-18	-6	1.77	45	1-1/4	32	11/16	3/4
20890-12-12	1-1/16-14	-12	2.34	59	1-11/16	43	1-1/8	1-1/4

22890 SAE Male Inverted Swivel Straight

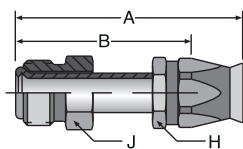

Construction: Steel nipple, nut and socket. Add "C" for Stainless Steel.

Part Number	Thread Size	Hose Size	A		Cutoff Allow. B		H Hex inch	J Hex inch
			inch	mm	inch	mm		
22890-4-4	7/16-24	-4	2.15	55	1-11/16	43	9/16	7/16
22890-5-5	1/2-20	-5	2.21	56	1-11/16	43	5/8	1/2
22890-5-6	1/2-20	-6	2.20	56	1-11/16	43	11/16	1/2
22890-6-6	5/8-18	-6	2.22	56	1-11/16	43	11/16	5/8
22890-8-8	3/4-18	-8	2.34	59	1-13/16	46	13/16	3/4
22890-10-10	7/8-18	-10	2.53	64	1-7/8	48	15/16	7/8
22890-12-12	1-1/16-16	-12	3.01	76	2-3/8	60	1-1/8	1-1/16



WARNING

This product can expose you to chemicals including Lead, which is known to the State of California to cause cancer and birth defects or other reproductive harm. For more information go to www.P65Warnings.ca.gov.

Fittings - Field Attachable

90 Series

23490 Straight Tube

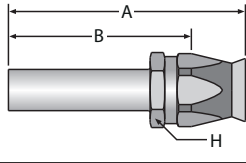

Construction: Brass nipple and ferrule, steel socket.

Part Number	Hose Size	Tube Size		A		Cutoff Allow. B		H Hex inch
		inch	mm	inch	mm	inch	mm	
23490-8-8	-8	1/2	6	3.06	78	2-1/2	64	13/16
23490-8-10	-10	1/2	8	3.15	80	2-1/2	64	1
23490-10-8	-8	5/8	8	3.26	83	2-5/8	67	13/16
23490-10-10	-10	5/8	10	3.28	83	2-5/8	67	1
23490-12-12	-12	3/4	13	3.28	83	2-11/16	68	1-1/8

NOTE: 26T90 fitting includes 23490 with the 60HAB sleeve & 61HAB nut.

23790 JIC 37° Swivel 45° Elbow

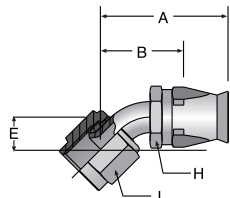

Construction: Steel nipple, nut and socket. Add "C" for Stainless Steel.

Part Number	Thread Size	Hose Size	A		Cutoff Allow. B		E		H Hex inch	J Hex inch
			inch	mm	inch	mm	inch	mm		
23790-4-4	7/16-20	-4	1.79	45	1-3/8	35	0.33	8	9/16	9/16
23790-5-5	1/2-20	-5	1.86	47	1-3/8	35	0.36	9	5/8	5/8
23790-6-6	9/16-18	-6	1.96	50	1-7/16	37	0.39	10	11/16	11/16
23790-8-6	3/4-16	-6	2.11	54	1-11/16	43	0.55	14	11/16	7/8
23790-8-8	3/4-16	-8	2.40	61	1-3/4	44	0.55	14	13/16	7/8
23790-10-10	7/8-14	-10	2.45	62	1-7/8	48	0.63	16	15/16	1
23790-12-12	1-1/16-12	-12	3.04	77	2-7/16	62	0.78	20	1-1/8	1-1/4
23790-16-16	1-5/16-12	-16	3.28	83	2-11/16	68	0.90	23	1-3/8	1-1/2
23790-20-20	1-5/8-12	-20	3.70	94	3-1/16	78	1.18	30	1-3/4	2

23990 JIC 37° Swivel 90° Elbow Short Drop

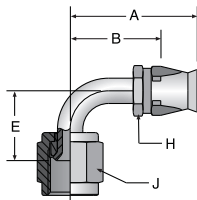

Construction: Steel nipple, nut and socket. Add "C" for Stainless Steel.

Part Number	Thread Size	Hose Size	A		Cutoff Allow. B		E		H Hex inch	J Hex inch
			inch	mm	inch	mm	inch	mm		
23990-4-4	7/16-20	-4	1.67	41	1-1/4	32	0.68	17	9/16	9/16
23990-5-5	1/2-20	-5	1.75	44	1-1/4	32	0.77	20	5/8	5/8
23990-6-6	9/16-18	-6	1.86	47	1-3/8	35	0.85	22	11/16	11/16
23990-8-6	3/4-16	-6	1.95	50	1-7/16	37	1.09	28	11/16	7/8
23990-8-8	3/4-16	-8	2.15	55	1-1/2	38	1.09	28	13/16	7/8
23990-10-10	7/8-14	-10	2.38	60	1-3/4	44	1.23	31	15/16	1
23990-12-12	1-1/16-12	-12	2.95	75	2-5/16	59	1.82	46	1-1/8	1-1/4
23990-16-16	1-5/16-12	-16	3.13	80	2-1/2	64	2.14	54	1-3/8	1-1/2
23990-20-20	1-5/8-12	-20	3.54	90	2-7/8	73	2.57	65	1-3/4	2

WARNING This product can expose you to chemicals including Lead, which is known to the State of California to cause cancer and birth defects or other reproductive harm. For more information go to www.P65Warnings.ca.gov.

Fittings - Field Attachable

90 Series

26190 SAE Compression Air Brake

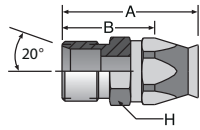

Construction: Brass nipple and ferrule, steel socket.

Part Number	Thread Size	Hose Size	A		Cutoff Allow. B		H Hex inch
			inch	mm	inch	mm	
26190-8-8	11/16-20	-8	1.69	43	1-1/16	27	13/16
26190-8-10	11/16-20	-10	1.86	47	1-3/16	30	1
26190-10-10	13/16-18	-10	1.92	49	1-1/4	32	1
26190-12-10	1-18	-10	2.09	53	1-7/16	37	1
26190-12-12	1-18	-12	2.09	53	1-7/16	37	1-1/8

26790 SAE Male Inverted Swivel 45° Elbow

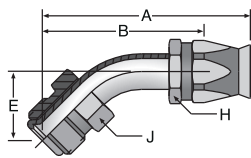

Construction: Steel nipple, nut and socket. Add "C" for Stainless Steel.

Part Number	Thread Size	Hose Size	A		Cutoff Allow. B		E		H Hex inch	J Hex inch
			inch	mm	inch	mm	inch	mm		
26790-4-4	7/16-24	-4	2.11	54	1-11/16	43	0.63	16	9/16	7/16
26790-5-5	1/2-20	-5	2.51	64	2	51	0.94	24	5/8	1/2
26790-5-6	1/2-20	-6	2.55	65	2-1/16	52	0.94	24	11/16	1/2
26790-6-6	5/8-18	-6	2.61	66	2-1/8	54	0.94	24	11/16	5/8
26790-8-8	3/4-18	-8	2.97	75	2-3/8	60	0.94	24	13/16	3/4
26790-8-10	3/4-18	-10	3.05	77	2-7/16	62	0.94	24	15/16	3/4
26790-10-10	7/8-18	-10	3.43	87	2-11/16	68	1.02	26	15/16	7/8
26790-12-12	1-1/16-16	-12	3.83	97	3-3/16	81	1.15	29	1-1/8	1-1/16

26990 SAE Male Inverted Swivel 90° Elbow

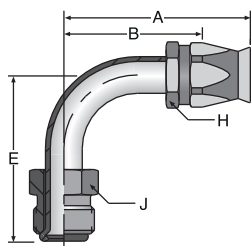

Construction: Steel nipple, nut and socket. Add "C" for Stainless Steel.

Part Number	Thread Size	Hose Size	A		Cutoff Allow. B		E		H Hex inch	J Hex inch
			inch	mm	inch	mm	inch	mm		
26990-4-4	7/16-24	-4	1.79	45	1-5/16	33	1.19	30	9/16	7/16
26990-5-5	1/2-20	-5	2.01	51	1-1/2	38	1.65	42	5/8	1/2
26990-5-6	1/2-20	-6	2.05	52	1-9/16	40	1.65	42	11/16	1/2
26990-6-6	5/8-18	-6	2.03	52	1-1/2	38	1.70	43	11/16	5/8
26990-8-8	3/4-18	-8	2.30	58	1-11/16	43	1.78	45	13/16	3/4
26990-8-10	3/4-18	-10	2.39	61	1-3/4	44	1.78	45	15/16	3/4
26990-10-10	7/8-18	-10	3.16	80	2-1/2	64	2.18	55	15/16	7/8
26990-12-12	1-1/16-16	-12	3.56	90	2-15/16	75	2.51	64	1-1/8	1-1/16



WARNING

This product can expose you to chemicals including Lead, which is known to the State of California to cause cancer and birth defects or other reproductive harm. For more information go to www.P65Warnings.ca.gov.

Fittings - Field Attachable

90 Series

27790 SAE 45° Swivel 45° Elbow

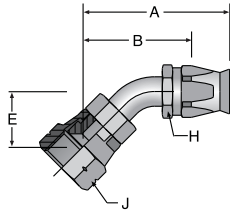

Part Number	Thread Size	Hose Size	A		Cutoff Allow. B		E		H Hex	J Hex
			inch	mm	inch	mm	inch	mm	inch	inch
27790-6-6	5/8-18	-6	1.72	44	1-3/16	30	0.39	10	11/16	3/4
27790-12-12	1-1/16-14	-12	3.03	77	2-3/8	60	0.78	20	1-1/8	1-1/4

Construction: Steel nipple, nut and socket. Add "C" for Stainless Steel.

27990 SAE 45° Swivel 90° Elbow

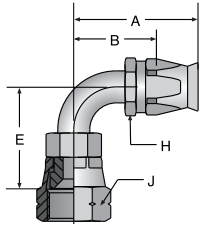

Part Number	Thread Size	Hose Size	A		Cutoff Allow. B		E		H Hex	J Hex
			inch	mm	inch	mm	inch	mm	inch	inch
27990-6-6	5/8-18	-6	1.86	47	1-3/8	35	.85	22	11/16	3/4
27990-8-8	3/4-16	-8	2.09	53	1-1/2	38	1.09	28	13/16	7/8
27990-12-12	1-1/16-14	-12	2.95	75	2-5/16	39	1.82	46	1-1/8	1-1/4

Construction: Steel nipple, nut and socket. Add "C" for Stainless Steel.

WARNING This product can expose you to chemicals including Lead, which is known to the State of California to cause cancer and birth defects or other reproductive harm. For more information go to www.P65Warnings.ca.gov.

Fittings - Field Attachable

BU Series

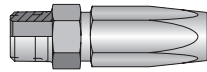
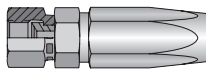
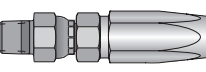
BU Series	201 Male Taper Pipe Rigid	206 Female SAE (JIC) 37° Swivel	213 Male Taper Pipe Swivel
Field Attachable			
	E-31	E-31	E-31

201BU Male Taper Pipe Rigid

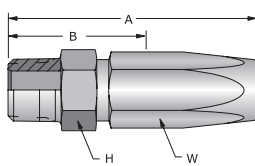

Construction: Steel.

Part Number	Thread Size	Hose I.D.		A		Cutoff Allow. B		H Hex	W Hex
		inch	mm	inch	mm	inch	mm	inch	inch
201BU-2-2	1/8-27	1/8	3	1.50	38	1	25	7/16	7/16

206BU Female SAE (JIC) 37° Swivel

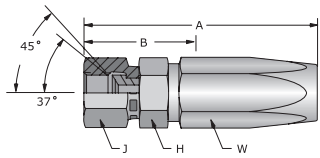

Construction: Steel.

Part Number	Thread Size	Hose I.D.		A		Cutoff Allow. B		H Hex	J Hex	W Hex
		inch	mm	inch	mm	inch	mm	inch	inch	inch
206BU-3-2	3/8-24	1/8	3	1.72	44	1-3/16	30	1/2	9/16	7/16
206BU-4-2	7/16-20	1/8	3	1.77	45	1-3/16	30	9/16	9/16	7/16
206BU-4-3	7/16-20	3/16	5	1.89	48	1-1/16	27	9/16	9/16	7/16

NOTE: Size -4 incorporates a dual seat.

213BU Male Taper Pipe Swivel

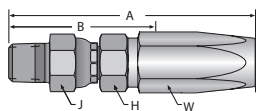

Construction: Steel.

Part Number	Thread Size	Hose I.D.		A		Cutoff Allow. B		H Hex	J Hex	W Hex
		inch	mm	inch	mm	inch	mm	inch	inch	inch
213BU-2-2	1/8-27	1/8	3	2.07	53	1-1/2	38	1/2	1/2	7/16

NOTE: Nitrile O-ring.



WARNING

This product can expose you to chemicals including Lead, which is known to the State of California to cause cancer and birth defects or other reproductive harm. For more information go to www.P65Warnings.ca.gov.

Fittings - Field Attachable

MS Series

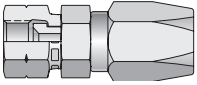
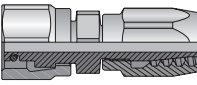
MS Series Field Attachable	208	SAE 45° Swivel	2TF	Marine Tube Connector
	 E-32		 E-32	

NOTE: MS Series is also available in a permanent crimp design. The fittings are listed with crimp fittings, pg. E-80.

208MS SAE 45° Swivel (Brass)

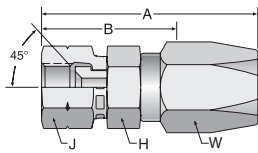

Construction: Brass.

Part Number	Thread Size	Hose I.D.		A		Cutoff Allow. B		H Hex	J Hex	W Hex
		inch	mm	inch	mm	inch	mm	inch	inch	inch
208MS-6-5B	5/8-18	5/16	8	2.06	52	1 5/16	33	13/16	5/8	5/8
208MS-6-6B	5/8-18	3/8	10	2.37	60	1 7/16	37	13/16	5/8	5/8

2TFMS Marine Tube Connector (Brass)

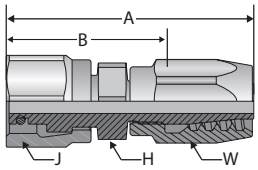

Construction: Brass.

Part Number	Thread Size	Hose I.D.		A		Cutoff Allow. B		H Hex	J Hex	W Hex
		inch	mm	inch	mm	inch	mm	inch	inch	inch
2TFMS-6-5B	9/16-24	5/16	8	2.02	51	1 5/16	33	3/4	5/8	5/8







NOTE: Nitrile O-ring.

Connector Mates are manufactured by the Fluid Systems Connection Division. Refer to Catalog 3501E for more information.

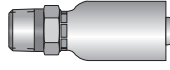
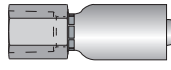
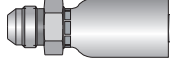
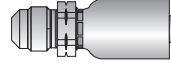
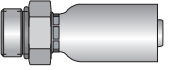
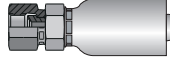
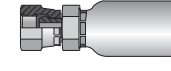
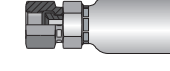
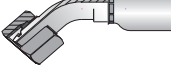
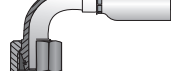
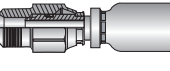
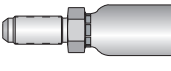
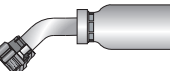
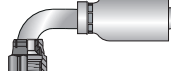
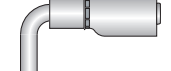
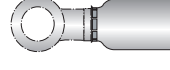
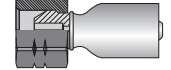
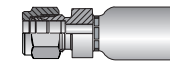
WARNING This product can expose you to chemicals including Lead, which is known to the State of California to cause cancer and birth defects or other reproductive harm. For more information go to www.P65Warnings.ca.gov.

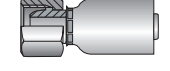
Fittings - Permanent Crimp

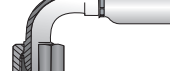
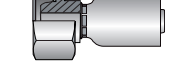
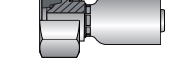
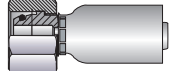
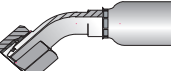
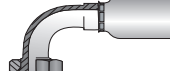
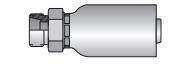
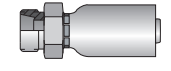
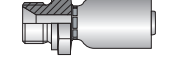
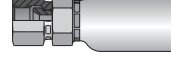
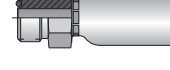
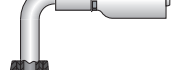
56 Series

56 Series Permanent	101 Male Taper Pipe Rigid	102 Female Taper Pipe Rigid	103 Male (JIC) 37° Rigid	104 Male SAE 45° Rigid	105 Male Str. Thread O-ring
					
	E-34	E-34	E-35	E-35	E-35
	106 SAE (JIC) 37° Swivel	107 Female Pipe Swivel	108 Female SAE 45° Swivel	10C M FM Swivel 24° O-ring 45° Elb. Lt.	11C M FM Swivel 24° O-ring 90° Elb. Lt.
				METRIC (M) 	METRIC (M) 
	E-36	E-36	E-37	E-43	E-43
	113 Male Pipe Swivel	13E Male (JIC) 37° Long	137 FM JIC 37° Swivel 45° Elbow	139 FM JIC 37° Swivel 90° Elbow	141 FM JIC 37° Swivel 90° Elbow-Lg
					
	E-37	E-37	E-38	E-38	E-39
	149 Banjo Union	192 FM BSP Parallel Pipe Swivel Str.	1AL A-Lok® Compression	1B1 FM BSP Pipe Swivel 45° Elb. (60° Cone)	1B2 FM BSP Pipe Swivel 90° Elb. (60° Cone)
	METRIC (M) 				
E-39	E-43	E-44	E-44	E-44	
1C3 M FM Swivel Nut Light	1C4 M FM Swivel 45° Elbow Lt.	1C5 M FM Swivel 90° Elbow Lt.	1C6 M FM Swivel DIN 20078 HW w/o O-ring	1C9 M FM Swivel DIN 20078 HW O-ring	
METRIC (M) 	METRIC (M) 	METRIC (M) 	METRIC (M) 	METRIC (M) 	
E-45	E-45	E-45	E-46	E-46	
1CA M FM Swivel 24° Lt. O-ring	1CE M FM Swivel 24° O-ring 45° Elb.	1CF M FM Swivel 24° O-ring 90° Elb.	1D0 M Male Stud DIN 20078 Lt.	1D2 M Male Stud 24° Heavy	
METRIC (M) 	METRIC (M) 	METRIC (M) 	METRIC (M) 	METRIC (M) 	
E-47	E-47	E-48	E-49	E-49	
1D9 Male BSPP - Str. (60° Cone)	1FU JIS/BSP 30° Flare Swivel Female	1J0 Male Seal-Lok™ Rigid Str. w/O-ring	1J1 Female Seal-Lok™ 90° Elbow Long	1J2 Female Seal-Lok™ 30° Elbow	
					
E-49	E-48	E-40	E-40	E-41	





WARNING

This product can expose you to chemicals including Lead, which is known to the State of California to cause cancer and birth defects or other reproductive harm. For more information go to www.P65Warnings.ca.gov.

Fittings - Permanent Crimp

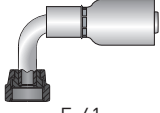
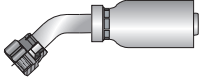
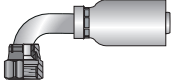
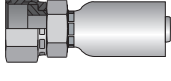
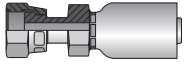
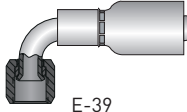
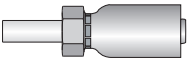
56 Series

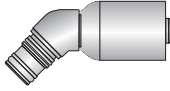
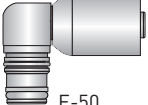
56 Series Permanent	1J5 Female Seal-Lok™ Swivel 90° Elb.Med.	1J7 Female Seal-Lok™ Swivel 45° Elbow	1J9 Female Seal-Lok™ Swivel 90° Elb Short	1JC Female Seal-Lok™ Str. Swivel Short	1JS Female Seal-Lok™ Straight
	 E-41	 E-42	 E-42	 E-40	 E-41
	1L9 Female JIC 37° Swivel 90° Elb.Med.	1TU Universal Inch Tube Stub End			
	 E-39	 E-42			

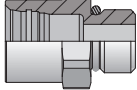
56 Series Permanent RAPID ASSEMBLY	1WW Male Rapid Assembly, 45° Elb.	1WY Male Rapid Assembly, 90° Elb.	1WU Male Rapid Assembly, Straight	685RA Female Rapid Assy. Adapter Male SAE
	 E-50	 E-50	 E-50	 E-50

10156 Male Taper Pipe Rigid

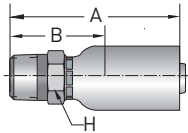

Construction: Steel. Add "C" for Stainless Steel.

Part Number	Thread Size	Hose I.D.		A		Cutoff Allow. B		H Hex inch
		inch	mm	inch	mm	inch	mm	
10156-2-2	1/8-27	1/8	3	1.35	34	3/4	19	1/2
10156-2-3	1/8-27	3/16	5	1.60	41	7/8	22	9/16
10156-4-2	1/4-18	1/8	3	1.56	40	15/16	24	5/8
10156-4-3	1/4-18	3/16	5	1.82	46	1-1/8	28	9/16
10156-4-4	1/4-18	1/4	6	2.09	53	1-1/8	28	9/16
10156-4-6	1/4-18	3/8	10	2.16	55	1-3/16	30	11/16
10156-6-6	3/8-18	3/8	10	2.16	55	1-3/16	30	3/4
10156-8-8	1/2-14	1/2	13	2.55	65	1-7/16	37	7/8
10156-12-10	3/4-14	5/8	16	2.88	73	1-9/16	40	1-1/8
10156-12-12	3/4-14	3/4	19	2.97	75	1-5/8	41	1-1/16
10156-16-16	1-11-1/2	1	25	3.76	96	1-7/8	48	1-3/8

10256 Female Taper Pipe Rigid

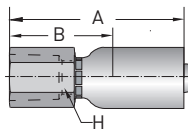

Construction: Steel. Add "C" for Stainless Steel.

Part Number	Thread Size	Hose I.D.		A		Cutoff Allow. B		H Hex inch
		inch	mm	inch	mm	inch	mm	
10256-4-4	1/4-18	1/4	6	1.99	51	1	25	11/16

WARNING This product can expose you to chemicals including Lead, which is known to the State of California to cause cancer and birth defects or other reproductive harm. For more information go to www.P65Warnings.ca.gov.

Fittings - Permanent Crimp

56 Series

10356 Male (JIC) 37° Rigid

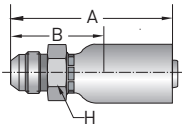

Construction: Steel. Add "C" for Stainless Steel.

Part Number	Thread Size	Hose I.D.		A		Cutoff Allow. B		H Hex inch
		inch	mm	inch	mm	inch	mm	
10356-4-3	7/16-20	3/16	5	1.83	46	1-1/8	28	9/16
10356-4-4	7/16-20	1/4	6	2.10	53	1-1/8	28	9/16
10356-5-4	1/2-20	1/4	6	2.10	53	1-1/8	28	9/16
10356-6-4	9/16-18	1/4	6	2.14	54	1-3/16	30	11/16
10356-6-5	9/16-18	5/16	8	2.22	56	1-3/16	30	11/16
10356-5-6	1/2-20	3/8	10	2.14	54	1-1/8	28	5/8
10356-6-6	9/16-18	3/8	10	2.15	55	1-3/16	30	5/8
10356-8-6	3/4-16	3/8	10	2.25	57	1-1/4	32	13/16
10356-8-8	3/4-16	1/2	13	2.40	61	1-5/16	33	7/8
10356-10-8	7/8-14	1/2	13	2.60	66	1-1/2	38	15/16
10356-12-10	1-1/16-12	5/8	16	2.97	75	1-5/8	42	1-1/8
10356-12-12	1-1/16-12	3/4	19	3.07	78	1-3/4	44	1-1/8
10356-16-16	1-5/16-12	1	25	3.66	93	1-3/4	44	1-3/8

10456 Male SAE 45° Rigid

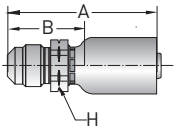

Construction: Steel. Add "C" for Stainless Steel.

Part Number	Thread Size	Hose I.D.		A		Cutoff Allow. B		H Hex inch
		inch	mm	inch	mm	inch	mm	
10456-4-3	7/16-20	3/16	5	1.71	43	1	25	9/16
10456-5-4	1/2-20	1/4	6	2.11	54	1-1/8	28	9/16
10456-6-5	5/8-18	5/16	8	2.18	55	1-3/16	30	11/16
10456-6-6	5/8-18	1/2	13	2.16	55	1-3/16	30	11/16
10456-6-8	5/8-18	1/2	13	2.37	60	1-1/4	32	3/4
10456-8-8	3/4-16	1/2	13	0.25	64	1-3/8	35	7/8
10456-12-12	1-1/16-14	3/4	19	3.11	79	1-3/4	44	1-1/8

10556 Male Straight Thread O-ring (Nitrile O-ring included)

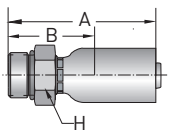

Construction: Steel. Add "C" for Stainless Steel.

Part Number	Thread Size	Hose I.D.		A		Cutoff Allow. B		H Hex inch
		inch	mm	inch	mm	inch	mm	
10556-4-3	7/16-20	3/16	4	1.61	41	15/16	24	9/16
10556-6-3	9/16-18	3/16	4	1.64	42	15/16	24	11/16
10556-4-4	7/16-20	1/4	6	1.84	47	7/8	22	9/16
10556-5-4	1/2-20	1/4	6	1.84	47	7/8	22	5/8
10556-6-4	9/16-18	1/4	6	1.91	49	15/16	24	11/16
10556-4-5	7/16-20	5/16	8	1.91	49	7/8	22	5/8
10556-5-5	1/2-20	5/16	8	1.91	49	7/8	22	5/8
10556-6-6	9/16-18	3/8	10	1.95	50	15/16	24	11/16
10556-8-6	3/4-16	3/8	10	1.98	50	1	25	7/8
10556-8-8	3/4-16	1/2	12	2.21	56	1-1/8	28	7/8
10556-10-8	7/8-14	1/2	12	2.28	58	1-3/16	30	1

NOTE: Nitrile O-ring.



WARNING

This product can expose you to chemicals including Lead, which is known to the State of California to cause cancer and birth defects or other reproductive harm. For more information go to www.P65Warnings.ca.gov.

Fittings - Permanent Crimp

56 Series

10656 SAE (JIC) 37° Swivel

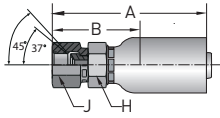

Construction: Steel. Add "C" for Stainless Steel.

Part Number	Thread Size	Hose I.D.		A		Cutoff Allow. B		H Hex inch	J Hex inch
		inch	mm	inch	mm	inch	mm		
10656-2-2	5/16-24	1/8	3	1.63	41	1	25	1/2	1/2
10656-3-2	3/8-24	1/8	3	1.60	41	1	25	1/2	9/16
10656-4-2	7/16-20	1/8	3	1.68	43	1	25	1/2	5/8
10656-3-3	3/8-24	3/16	5	1.91	49	1-3/16	30	1/2	1/2
10656-4-3	7/16-20	3/16	5	1.78	45	1-1/16	27	9/16	9/16
10656-5-3	1/2-20	3/16	5	1.84	47	1-1/8	28	9/16	5/8
10656-2-4	3/8-24	1/4	6	1.98	50	1	25	1/2	7/16
10656-4-4	7/16-20	1/4	6	2.05	52	1-1/16	27	9/16	9/16
10656-5-4	1/2-20	1/4	6	2.12	54	1-1/8	28	9/16	5/8
10656-6-4	9/16-18	1/4	6	2.14	54	1-3/16	30	9/16	11/16
10656-4-5	7/16-20	5/16	8	2.10	53	1-1/16	27	9/16	9/16
10656-5-5	1/2-20	5/16	8	2.21	56	1-3/16	30	5/8	5/8
10656-6-5	9/16-18	5/16	8	2.23	57	1-3/16	30	5/8	11/16
10656-4-6	7/16-20	3/8	10	2.09	53	1-1/8	28	9/16	9/16
10656-5-6	1/2-20	3/8	10	2.23	57	1-1/4	32	5/8	5/8
10656-6-6	9/16-18	3/8	10	2.22	56	1-1/4	32	11/16	11/16
10656-8-6	3/4-16	3/8	10	2.37	60	1-3/8	35	11/16	7/8
10656-6-8	9/16-18	1/2	13	2.42	61	1-5/16	33	3/4	11/16
10656-8-8	3/4-16	1/2	13	2.54	64	1-7/16	36	13/16	7/8
10656-10-8	7/8-14	1/2	13	2.64	67	1-1/2	38	7/8	1
10656-8-10	3/4-16	5/8	16	2.73	69	1-7/16	36	15/16	7/8
10656-10-10	7/8-14	5/8	16	2.99	76	1-11/16	43	15/16	1
10656-12-10	1-1/16-12	5/8	16	3.06	78	1-3/4	44	1-1/16	1-1/4
10656-10-12	7/8-14	3/4	19	2.88	73	1-1/2	38	1-1/16	1
10656-12-12	1-1/16-12	3/4	19	3.06	78	1-3/4	44	1-1/16	1-1/4
10656-16-12	1-5/16-12	3/4	19	3.27	83	1-15/16	49	1-1/4	1-1/2
10656-16-16	1-5/16-12	1	25	3.81	97	1-15/16	49	1-3/8	1-1/2
10656-20-16	1-5/8-12	1	25	3.96	101	2-1/16	52	1-5/8	2

NOTE: Sizes -4, -5, -8 and -10 incorporate a dual seat.

10756 Female Pipe Swivel

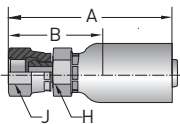

Construction: Steel. Add "C" for Stainless Steel.

Part Number	Thread Size	Hose I.D.		A		Cutoff Allow. B		H Hex inch	J Hex inch
		inch	mm	inch	mm	inch	mm		
10756-4-4	1/4-18	1/4	6	2.03	52	1-1/16	27	9/16	11/16
10756-4-5	1/4-18	5/16	8	2.09	53	1-1/16	27	9/16	11/16
10756-6-6	3/8-18	3/8	10	2.13	54	1-1/8	28	11/16	7/8
10756-8-8	1/2-14	1/2	13	2.40	61	1-5/16	33	7/8	1
10756-12-12	3/4-14	3/4	19	2.98	76	1-5/8	41	1-1/16	1-1/4
10756-16-16	1-11-1/2	1	25	3.74	95	1-7/8	48	1-3/8	1-1/2



WARNING

This product can expose you to chemicals including Lead, which is known to the State of California to cause cancer and birth defects or other reproductive harm. For more information go to www.P65Warnings.ca.gov.

Fittings - Permanent Crimp

56 Series

10856 Female SAE 45° Swivel

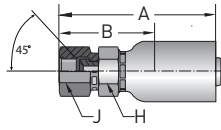

Construction: Steel. Add "C" for Stainless Steel.

Part Number	Thread Size	Hose I.D.		A		Cutoff Allow. B		H Hex inch	J Hex inch
		inch	mm	inch	mm	inch	mm		
10856-6-4	5/8-18	1/4	6	2.19	56	1-1/4	32	11/16	3/4
10856-6-5	5/8-18	5/16	8	2.28	58	1-1/4	32	11/16	3/4
10856-6-6	5/8-18	3/8	10	2.36	60	1-3/8	35	11/16	3/4
10856-12-12	1-1/16-14	3/4	19	3.06	78	1-3/4	44	1-1/16	1-1/4

11356 Male Pipe Swivel

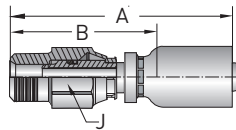

Construction: Steel. Add "C" for Stainless Steel.

Part Number	Thread Size	Hose I.D.		A		Cutoff Allow. B		J Hex inch
		inch	mm	inch	mm	inch	mm	
11356-2-2	1/8-27	1/8	3	1.96	50	1-5/16	33	1/2
11356-2-3	1/8-27	3/16	5	2.17	73	1-1/2	54	5/8
11356-4-3	1/4-18	3/16	5	2.59	66	1-7/8	48	5/8
11356-4-4	1/4-18	1/4	6	2.95	75	2	50	5/8
11356-4-5	1/4-18	5/16	8	2.77	75	1-3/4	49	5/8
11356-6-6	3/8-18	3/8	10	3.06	78	2-1/16	52	3/4
11356-8-6	1/2-14	3/8	10	3.24	82	2-1/4	57	15/16
11356-8-8	1/2-14	1/2	13	3.37	86	2-1/4	57	15/16
11356-12-12	3/4-14	3/4	19	3.71	94	2-3/8	60	1-1/4
11356-16-16	1-11-1/2	1	25	4.35	118	2-7/16	70	1-1/2

NOTE: Nitrile O-ring.

13E56 Male (JIC) 37° Long

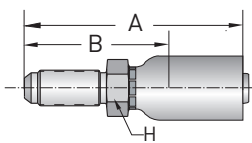

Construction: Steel. Add "C" for Stainless Steel.

Part Number	Thread Size	Hose I.D.		A		Cutoff Allow. B		H Hex inch
		inch	mm	inch	mm	inch	mm	
13E56-4-4	7/16-20	1/4	6	2.80	71	1-13/16	46	5/8
13E56-6-5	9/16-18	5/16	8	2.97	75	1-15/16	49	3/4
13E56-6-6	9/16-18	3/8	10	2.97	75	2	50	7/8
13E56-8-8	3/4-16	1/2	13	3.24	82	2-1/8	54	7/8

NOTE: Bulkhead Locknut sold separately. WLN Locknuts are manufactured by the Tube Fittings Division. Refer to Catalog 4300 for additional information.



WARNING

This product can expose you to chemicals including Lead, which is known to the State of California to cause cancer and birth defects or other reproductive harm. For more information go to www.P65Warnings.ca.gov.

Fittings - Permanent Crimp

56 Series

13756 Female JIC 37° Swivel 45° Elbow

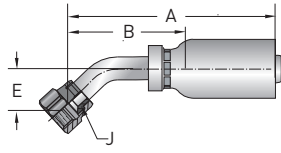

Construction: Steel. Add "C" for Stainless Steel.

Part Number	Thread Size	Hose I.D.		A		Cutoff Allow. B		E		J Hex
		inch	mm	inch	mm	inch	mm	inch	mm	inch
13756-4-2	7/16-20	1/8	3	1.98	50	1-5/16	33	.33	8	9/16
13756-4-3	7/16-20	3/16	5	1.93	49	1-1/4	32	.39	10	9/16
13756-4-4	7/16-20	1/4	6	2.19	56	1-1/4	32	.39	10	9/16
13756-5-4	1/2-20	1/4	6	2.46	62	1-1/2	38	.39	10	5/8
13756-6-4	9/16-18	1/4	6	2.24	57	1-1/4	32	.43	11	11/16
13756-6-5	9/16-18	5/16	8	2.53	64	1-1/2	38	.43	11	11/16
13756-6-6	9/16-18	3/8	10	2.57	65	1-9/16	40	.43	11	11/16
13756-8-6	3/4-16	3/8	10	2.76	70	1-3/4	44	.59	15	7/8
13756-8-8	3/4-16	1/2	13	2.72	69	1-5/8	41	.59	15	7/8
13756-10-8	7/8-14	1/2	13	2.87	73	1-3/4	45	.63	16	1
13756-10-10	7/8-14	5/8	16	3.23	83	2	50	.63	16	1
13756-12-10	1-1/16-12	5/8	16	3.74	95	2.40	61	.83	21	1-1/4
13756-12-12	1-1/16-12	3/4	19	4.03	102	2-11/16	68	.83	21	1-1/4
13756-16-16	1-5/16-12	1	25	4.53	115	2.63	67	.94	24	1-1/2

13956 Female JIC 37° Swivel 90° Elbow

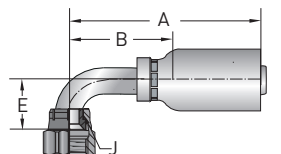

Construction: Steel. Add "C" for Stainless Steel.

Part Number	Thread Size	Hose I.D.		A		Cutoff Allow. B		E		J Hex
		inch	mm	inch	mm	inch	mm	inch	mm	inch
13956-4-2	7/16-20	1/8	3	1.83	46	1-1/4	32	.68	17	9/16
13956-4-3	7/16-20	3/16	5	1.75	44	1-1/16	27	.83	21	9/16
13956-4-4	7/16-20	1/4	6	2.01	51	1-1/16	27	.83	21	9/16
13956-5-4	1/2-20	1/4	6	2.01	51	1-1/16	27	.83	21	5/8
13956-6-4	9/16-18	1/4	6	2.01	51	1-1/16	27	.91	23	11/16
13956-6-5	9/16-18	5/16	8	2.14	54	1-1/8	28	.91	23	11/16
13956-6-6	9/16-18	3/8	10	2.22	56	1-1/4	32	.91	23	11/16
13956-8-6	3/4-16	3/8	10	2.55	65	1-9/16	40	1.14	29	7/8
13956-8-8	3/4-16	1/2	13	2.48	63	1-3/8	35	1.14	29	7/8
13956-10-8	7/8-14	1/2	13	2.60	66	1-1/2	38	1.26	32	1
13956-10-10	7/8-14	5/8	16	2.96	75	1-5/8	41	1.26	32	1
13956-12-10	1-1/16-12	5/8	19	3.39	86	2-1/16	52	1.89	48	1-1/4
13956-12-12	1-1/16-12	3/4	19	3.89	99	2-9/16	65	1.89	48	1-1/4
13956-16-16	1-5/16-12	1	25	4.50	114	2.60	66	2.20	56	1-1/2

WARNING This product can expose you to chemicals including Lead, which is known to the State of California to cause cancer and birth defects or other reproductive harm. For more information go to www.P65Warnings.ca.gov.

Fittings - Permanent Crimp

56 Series

14156 Female JIC 37° Swivel 90° Elbow Long Drop

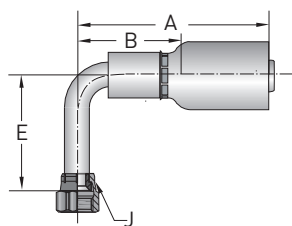

Construction: Steel. Add "C" for Stainless Steel.

Part Number	Thread Size	Hose I.D.		A		Cutoff Allow. B		E		J Hex
		inch	mm	inch	mm	inch	mm	inch	mm	inch
14156-4-3	7/16-20	3/16	5	2.00	51	1-5/16	33	1.81	46	9/16
14156-4-4	7/16-20	1/4	6	2.31	59	1-3/8	35	1.81	46	9/16
14156-5-4	1/2-20	1/4	6	2.34	60	1-3/8	35	1.81	46	5/8
14156-6-4	9/16-18	1/4	6	2.39	61	1-7/16	36	2.13	54	11/16
14156-6-5	9/16-18	5/16	8	2.36	60	1-5/16	33	2.13	54	11/16
14156-6-6	9/16-18	3/8	10	2.39	61	1-3/8	35	2.13	54	11/16
14156-8-6	3/4-16	3/8	10	2.49	63	1-1/2	38	2.52	64	7/8
14156-8-8	3/4-16	1/2	13	2.61	66	1-1/2	38	2.52	64	7/8
14156-10-8	7/8-14	1/2	13	2.48	63	1-3/8	35	2.76	70	1
14156-12-12	1-1/16-12	3/4	19	3.59	91	2-1/4	57	3.78	96	1-1/4
14156-16-16	1-5/16-12	1	25	4.36	111	2-1/2	63	4.49	114	1-1/2

1L956 Female JIC 37° Swivel 90° Elbow Medium Drop

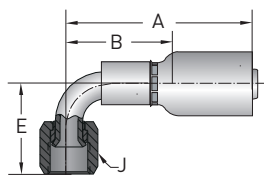

Construction: Steel. Add "C" for Stainless Steel.

Part Number	Thread Size	Hose I.D.		A		Cutoff Allow. B		E		J Hex
		inch	mm	inch	mm	inch	mm	inch	mm	inch
1L956-4-3	7/16-20	3/16	5	1.97	50	1-1/4	32	1.26	32	9/16
1L956-4-4	7/16-20	1/4	6	2.29	58	1-5/16	34	1.26	32	9/16
1L956-5-4	1/2-20	1/4	6	2.31	59	1-3/8	35	1.26	32	5/8
1L956-6-5	9/16-18	5/16	8	2.33	59	1-5/16	34	1.50	38	11/16
1L956-6-6	9/16-18	3/8	10	2.36	60	1-1/4	31	1.50	38	11/16
1L956-8-6	3/4-16	3/8	10	2.44	62	1-7/16	37	1.61	41	7/8
1L956-8-8	3/4-16	1/2	13	2.57	65	1-7/16	37	1.61	41	7/8
1L956-10-8	7/8-14	1/2	13	2.48	63	1-3/8	35	1.85	47	1
1L956-12-12	1-1/16-12	3/4	19	3.89	99	2-9/16	65	2.28	58	1-1/4
1L956-16-16	1-5/16-12	1	25	4.36	111	2-1/2	63	2.80	71	1-1/2

14956 - Banjo Union DIN7642

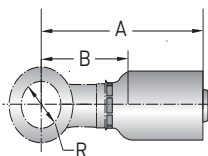

Construction: Steel.

Part Number	Diameter R	Hose I.D.		A		Cutoff Allow. B	
		mm	inch	mm	inch	mm	inch
14956-14-3	14	5	3/16	49	1.93	31	1.22
14956-12-4	12	6	1/4	50	1.97	25	1.5
14956-14-4	14	6	1/4	56	2.2	32	1.26
14956-12-5	12	8	5/16	54	2.13	29	1.14
14956-14-5	14	8	5/16	53	2.09	27	1.06
14956-16-6	16	10	3/8	58	2.28	33	1.3
14956-17-6	17	10	3/8	55	2.17	29	1.14



WARNING

This product can expose you to chemicals including Lead, which is known to the State of California to cause cancer and birth defects or other reproductive harm. For more information go to www.P65Warnings.ca.gov.

Fittings - Permanent Crimp

56 Series

1J056 Male Seal-Lok™ Rigid Straight w/O-ring ISO 12151-1-S

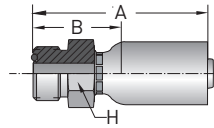

Construction: Steel. Add "C" for Stainless Steel.

Part Number	Thread Size	Hose I.D.		A		Cutoff Allow. B		H Hex inch
		inch	mm	inch	mm	inch	mm	
1J056-4-4	9/16-18	1/4	6	1.93	49	15/16	24	5/8
1J056-6-4	11/16-16	1/4	6	2.01	51	1-1/16	27	3/4
1J056-6-6	11/16-16	3/8	10	1.98	50	1	25	3/4
1J056-8-6	13/16-16	1/2	13	2.16	55	1-3/16	30	7/8
1J056-8-8	13/16-16	1/2	13	2.18	55	1-1/16	27	7/8

NOTE: Nitrile O-ring.

1J156 Female Seal-Lok™ Swivel 90° Elbow Long Drop ISO 12151-1-SWEL90

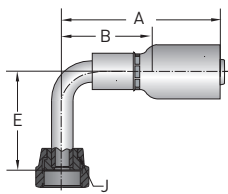

Construction: Steel. Add "C" for Stainless Steel.

Part Number	Thread Size	Hose I.D.		A		Cutoff Allow. B		E		J Hex inch
		inch	mm	inch	mm	inch	mm	inch	mm	
1J156-4-3	9/16-18	3/16	5	2.05	52	1-3/8	35	1.81	46	11/16
1J156-4-4	9/16-18	1/4	6	2.37	60	1-3/8	35	1.81	46	11/16
1J156-6-4	11/16-16	1/4	6	2.45	62	1-1/2	38	2.13	54	13/16
1J156-6-6	11/16-16	3/8	10	2.45	62	1-7/16	37	2.13	54	13/16
1J156-8-6	13/16-16	3/8	10	2.53	64	1-7/16	37	2.52	64	15/16
1J156-8-8	13/16-16	1/2	13	2.67	68	1-9/16	40	2.52	64	15/16
1J156-12-12	1-3/16-12	3/4	19	3.59	91	2-1/4	57	3.78	96	1-3/8
1J156-16-16	1-7/16-12	1	25	4.36	111	2-1/2	63	4.49	114	1-5/8

1JC56 Female Seal-Lok™ Straight Swivel Short ISO 12151-1-SWSA

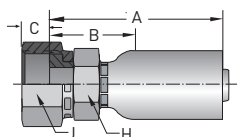

Construction: Steel. Add "C" for Stainless Steel.

Part Number	Thread Size	Hose I.D.		A		Cutoff Allow. B		C		H Hex inch	J Hex inch
		inch	mm	inch	mm	inch	mm	inch	mm		
1JC56-4-2	9/16-18	1/8	3	1.34	34	3/4	19	5/16	8	5/8	11/16
1JC56-4-3	9/16-18	3/16	5	1.58	40	7/8	22	5/16	8	9/16	11/16
1JC56-4-4	9/16-18	1/4	6	1.86	47	7/8	22	5/16	8	9/16	11/16
1JC56-6-4	11/16-16	1/4	6	1.90	48	15/16	24	.34	9	11/16	13/16
1JC56-4-5	9/16-18	5/16	8	1.81	46	13/16	21	5/16	8	11/16	11/16
1JC56-6-5	11/16-16	5/16	8	1.95	49	15/16	24	.34	9	11/16	13/16
1JC56-4-6	9/16-18	3/8	10	1.91	48	15/16	24	5/16	8	5/8	11/16
1JC56-6-6	11/16-16	3/8	19	1.89	48	7/8	22	.34	9	11/16	13/16
1JC56-8-6	13/16-16	3/8	10	2.00	51	1	25	7/16	11	13/16	15/16
1JC56-8-8	13/16-16	1/2	13	2.13	54	1	25	7/16	11	13/16	15/16
1JC56-10-8	1-14	1/2	13	2.30	58	1-3/16	30	.48	12	15/16	1-1/8
1JC56-10-10	1-14	5/8	16	2.48	63	1-3/16	30	.48	12	15/16	1-1/8
1JC56-12-10	1-3/16-12	5/8	16	2.61	66	1-5/16	33	9/16	14	1-1/8	1-3/8
1JC56-10-12	1-14	3/4	19	2.50	64	1-3/16	30	.48	12	1-1/8	1-1/8
1JC56-12-12	1-3/16-12	3/4	19	2.54	65	1-3/16	30	9/16	14	1-1/8	1-3/8
1JC56-16-16	1-7/16-12	1	25	3.21	82	1-5/16	33	9/16	14	1-3/8	1-5/8

NOTE: When measuring overall length to the end of the nut, B+C dimensions must be used to calculate cut-off allowance.



WARNING

This product can expose you to chemicals including Lead, which is known to the State of California to cause cancer and birth defects or other reproductive harm. For more information go to www.P65Warnings.ca.gov.

Fittings - Permanent Crimp

56 Series

1JS56 Female Seal-Lok™ Straight ISO 12151-1-SWSB

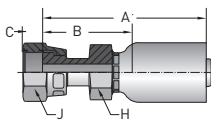

Construction: Steel. Add "C" for Stainless Steel.

Part Number	Thread Size	Hose I.D.		A		Cutoff Allow. B		H Hex inch	J Hex inch
		inch	mm	inch	mm	inch	mm		
1JS56-4-3	9/16-18	3/16	5	1.89	48	1-3/16	30	9/16	11/16
1JS56-4-4	9/16-18	1/4	6	2.17	51	1-3/16	30	9/16	11/16
1JS56-6-4	11/16-16	1/4	6	2.24	57	1-1/4	32	11/16	13/16
1JS56-6-5	11/16-16	5/16	8	2.29	58	1-1/4	32	11/16	13/16
1JS56-6-6	11/16-16	3/8	10	2.28	58	1-5/16	33	11/16	13/16
1JS56-8-6	13/16-16	3/8	10	2.40	61	1-7/16	36	13/16	15/16
1JS56-6-8	11/16-16	1/2	13	2.40	61	1-5/16	33	3/4	13/16
1JS56-8-8	13/16-16	1/2	13	2.52	64	1-3/8	35	13/16	15/16
1JS56-10-8	1-14	1/2	13	2.68	68	1-9/16	40	15/16	1-1/8
1JS56-10-10	1-14	5/8	16	2.92	74	1-5/8	41	15/16	1-1/8
1JS56-12-12	1-3/16-12	3/4	19	3.17	81	1-13/16	46	1-1/8	1-3/8
1JS56-16-16	1-7/16-12	1	25	3.76	96	1-7/8	48	1-3/8	1-5/8

NOTE: When measuring overall length to the end of the nut, B+C dimensions must be used to calculate cut-off allowance.

1J256 Female Seal-Lok™ Swivel 30° Elbow

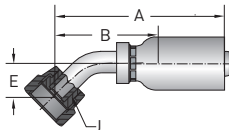

Construction: Steel. Add "C" for Stainless Steel.

Part Number	Thread Size	Hose I.D.		A		Cutoff Allow. B		E		J Hex inch
		inch	mm	inch	mm	inch	mm	inch	mm	
1J256-8-8	13/16-16	1/2	13	2.84	72	1-11/16	43	.43	11	15/16

1J556 Female Seal-Lok™ Swivel 90° Elbow Medium Drop ISO 12151-1-SWEM90

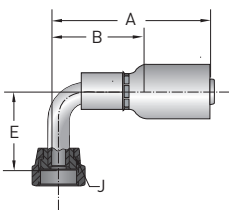

Construction: Steel. Add "C" for Stainless Steel.

Part Number	Thread Size	Hose I.D.		A		Cutoff Allow. B		E		J Hex inch
		inch	mm	inch	mm	inch	mm	inch	mm	
1J556-4-3	9/16-18	3/16	5	1.89	48	1-3/16	30	1.26	32	11/16
1J556-4-4	9/16-18	1/4	6	2.14	53	1-1/8	28	1.26	32	11/16
1J556-6-4	11/16-16	1/4	6	2.14	55	1-3/16	30	1.50	38	13/16
1J556-6-5	11/16-16	5/16	8	2.28	58	1-1/4	32	1.50	38	13/16
1J556-6-6	11/16-16	3/8	10	2.42	61	1-7/16	36	1.50	38	13/16
1J556-8-6	13/16-16	3/8	10	2.22	56	1-1/4	32	1.61	41	15/16
1J556-8-8	13/16-16	1/2	13	2.48	63	1-3/8	35	1.61	41	15/16
1J556-10-8	1-14	1/2	13	2.48	63	1-3/8	35	1.85	47	1-1/8
1J556-10-10	1-14	5/8	16	2.83	72	1-1/2	38	1.85	47	1-1/8
1J556-12-12	1-3/16-12	3/4	19	3.59	91	2-1/4	57	2.28	58	1-3/8
1J556-16-16	1-7/16-12	1	25	4.36	111	2-1/2	63	2.80	71	1-5/8



WARNING

This product can expose you to chemicals including Lead, which is known to the State of California to cause cancer and birth defects or other reproductive harm. For more information go to www.P65Warnings.ca.gov.

Fittings - Permanent Crimp

56 Series

1J756 Female Seal-Lok™ Swivel 45° Elbow ISO 12151-1-SWE45

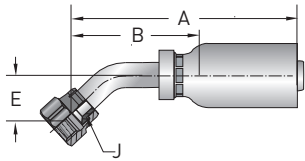

Construction: Steel. Add "C" for Stainless Steel.

Part Number	Thread Size	Hose I.D.		A		Cutoff Allow. B		E		J
		inch	mm	inch	mm	inch	mm	inch	mm	Hex inch
1J756-4-2	9/16-18	1/8	3	2.07	53	1-7/16	36	0.39	10	11/16
1J756-4-3	9/16-18	3/16	5	2.00	51	1-5/16	33	.39	10	11/16
1J756-4-4	9/16-18	1/4	6	2.25	57	1-1/4	32	.39	10	11/16
1J756-6-4	11/16-16	1/4	6	2.27	58	1-5/16	33	.43	11	13/16
1J756-6-5	11/16-16	5/16	8	2.32	59	1-3/8	35	.43	11	13/16
1J756-4-6	9/16-18	3/8	10	2.25	57	1-1/4	32	.39	10	11/16
1J756-6-6	11/16-16	3/8	10	2.35	60	1-3/8	35	.43	11	13/16
1J756-8-6	13/16-16	3/8	10	2.54	65	1-9/16	40	.59	15	15/16
1J756-8-8	13/16-16	1/2	13	2.72	69	1-5/8	41	.59	15	15/16
1J756-10-10	1-14	5/8	16	3.27	83	2	50	.63	16	1-1/8
1J756-12-12	1-3/16-12	3/4	19	4.03	102	2-11/16	68	.83	21	1-3/8
1J756-16-16	1-7/16-12	1	25	4.53	115	2.63	67	.94	24	1-5/8

1J956 Female Seal-Lok™ Swivel 90° Elbow Short Drop ISO 12151-1-SWE90

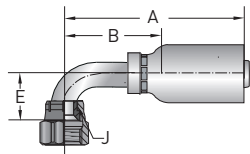

Construction: Steel. Add "C" for Stainless Steel.

Part Number	Thread Size	Hose I.D.		A		Cutoff Allow. B		E		J
		inch	mm	inch	mm	inch	mm	inch	mm	Hex inch
1J956-4-2	9/16-18	1/8	3	2.04	52	1-7/16	36	0.83	21	11/16
1J956-4-3	9/16-18	3/16	5	1.89	48	1-3/16	30	.83	21	11/16
1J956-4-4	9/16-18	1/4	6	2.14	53	1-1/8	28	.83	21	11/16
1J956-6-4	11/16-16	1/4	6	2.14	55	1-3/16	30	.91	23	13/16
1J956-6-5	11/16-16	5/16	8	2.28	58	1-1/4	32	.91	23	13/16
1J956-6-6	11/16-16	3/8	10	2.22	56	1-1/4	32	.91	23	13/16
1J956-8-6	13/16-16	3/8	10	2.22	56	1-1/4	32	1.14	29	15/16
1J956-8-8	13/16-16	1/2	13	2.48	63	1-3/8	35	1.14	29	15/16
1J956-10-8	1-14	1/2	13	2.48	63	1-3/8	35	1.26	32	1-1/8
1J956-10-10	1-14	5/8	16	3.14	80	1-13/16	46	1.26	32	1-1/8
1J956-12-12	1-3/16-12	3/4	19	3.89	99	2-9/16	65	1.89	48	1-3/8
1J956-16-16	1-7/16-12	1	25	4.50	114	2.60	66	2.20	56	1-5/8

1TU56 Universal Inch Tube Stub End

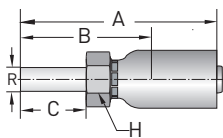

Construction: Steel. Add "C" for Stainless Steel.

Part Number	Diameter R	Hose I.D.		A		Cutoff Allow. B		C		H
		inch	mm	inch	mm	inch	mm	inch	mm	Hex inch
1TU56-4-4	1/4	1/4	6	2.35	60	1-3/8	35	.72	18	11/16
1TU56-6-4	3/8	1/4	6	2.41	61	1-7/16	36	.78	20	15/16
1TU56-6-6	3/8	3/8	10	2.46	62	1-7/16	36	.78	20	1-1/8
1TU56-8-8	1/2	1/2	13	2.68	68	1-9/16	40	1.03	26	1-1/8
1TU56-12-12	3/4	3/4	19	2.88	73	1-9/16	40	1.03	26	1-3/8
1TU56-16-16	1	1	25	4.03	102	1-7/8	48	1.03	26	1-5/8

WARNING This product can expose you to chemicals including Lead, which is known to the State of California to cause cancer and birth defects or other reproductive harm. For more information go to www.P65Warnings.ca.gov.

Fittings - Permanent Crimp

56 Series

10C56 - Metric Female Swivel 24° With O-ring 45° Elbow Light Series ISO 12151-2

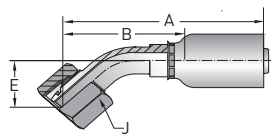

Construction: Steel. Add "C" for Stainless Steel.

Part Number	Thread Size	Hose I.D.		A		Cutoff Allow. B		E		J Hex
		mm	inch	mm	inch	mm	inch	mm	inch	mm
10C56-6-3	M14x1.5	5	3/16	58	2.28	40	1.57	16	0.63	17
10C56-8-3	M16x1.5	5	3/16	59	2.32	41	1.61	18	0.71	19
10C56-10-4	M18x1.5	6	1/4	64	2.52	40	1.57	17	0.67	22
10C56-12-5	M20x1.5	8	5/16	69	2.72	43	1.69	17	0.67	24
10C56-12-6	M20x1.5	10	3/8	75	2.95	49	1.93	20	0.79	24
10C56-16-8	M24x1.5	13	1/2	80	3.15	51	2.01	23	0.91	30

NOTE: Nitrile O-ring.

11C56 - Metric Female Swivel 24° With O-ring 90° Elbow Light Series ISO 12151-2

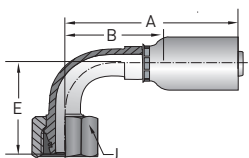

Construction: Steel. Add "C" for Stainless Steel.

Part Number	Thread Size	Hose I.D.		A		Cutoff Allow. B		E		J Hex
		mm	inch	mm	inch	mm	inch	mm	inch	mm
11C56-8-3	M16x1.5	5	3/16	48	1.89	30	1.18	29	1.14	19
11C56-10-4	M18x1.5	6	1/4	53	2.09	29	1.14	32	1.26	22
11C56-12-5	M20x1.5	8	5/16	65	2.56	39	1.54	34	1.34	24
11C56-12-6	M20x1.5	10	3/8	63	2.48	38	1.5	37	1.46	24
11C56-16-8	M24x1.5	13	1/2	68	2.68	40	1.57	45	1.77	30

NOTE: Nitrile O-ring.

19256 Female BSP Parallel Pipe Swivel Straight (60° Cone)

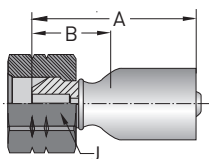

Construction: Steel. Add "C" for Stainless Steel.

Part Number	Thread Size	Hose I.D.		A		Cutoff Allow. B		J Hex
		mm	inch	mm	inch	mm	inch	mm
19256-4-3	G 1/4	5	3/16	35	1.38	17	0.67	19
19256-2-4	G 1/8	6	1/4	43	1.69	18	0.71	14
19256-4-4	G 1/4	6	1/4	42	1.65	17	0.67	19
19256-6-4	G 3/8	6	1/4	45	1.77	20	0.79	22
19256-4-5	G 1/4	8	5/16	47	1.85	21	0.83	19
19256-6-5	G 3/8	8	5/16	46	1.81	20	0.79	22
19256-6-6	G 3/8	10	3/8	46	1.81	21	0.83	22
19256-8-6	G 1/2	10	3/8	48	1.77	23	0.91	27
19256-6-8	G 3/8	13	1/2	53	2.09	25	0.98	22
19256-8-8	G 1/2	13	1/2	51	2.01	23	0.91	27
19256-10-8	G 5/8	13	1/2	49	1.93	22	0.87	30
19256-12-12	G 3/4	19	3/4	60	2.36	26	1.02	32
19256-16-16	G 1	25	1	74	2.91	26	1.02	41



WARNING

This product can expose you to chemicals including Lead, which is known to the State of California to cause cancer and birth defects or other reproductive harm. For more information go to www.P65Warnings.ca.gov.

Fittings - Permanent Crimp

56 Series

1AL56 A-LOK® Compression (With Nut and Ferrule)

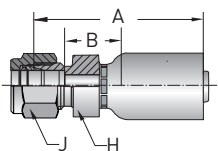

Construction: 316 Stainless nipple and shell.

Part Number	Thread Size	Hose I.D.		A		Cutoff Allow. B		H Hex	J Hex
		inch	mm	inch	mm	inch	mm	inch	inch
1AL56-4-4C	7/16-20	1/4	6	1/4	6	1.91	49	9/16	9/16
1AL56-6-6C	9/16-20	3/8	10	3/8	10	2.09	53	11/16	11/16
1AL56-8-8C	3/4-20	1/2	13	3/8	10	2.21	56	7/8	7/8

NOTE: Nut part No. is XNUX or XNUX-316 for stainless steel.
 Front ferrule part No. is XFFX or XFFX-316 for stainless steel.
 Back ferrule part No. is XBFX or XBFX-316 for stainless steel.
 X denotes dash size.

1B156 - Female BSP Parallel Pipe Swivel 45° Elbow (60° Cone) ISO 228-1

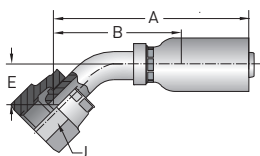

Construction: Steel. Add "C" for Stainless Steel.

Part Number	Thread Size	Hose I.D.		A		Cutoff Allow. B		E		J Hex
		mm	inch	mm	inch	mm	inch	mm	inch	mm
1B156-4-3	G 1/4	5	3/16	57	2.24	15	0.59	39	1.542	19
1B156-4-4	G 1/4	6	1/4	62	2.44	15	0.59	38	1.5	19
1B156-6-5	G 3/8	8	5/16	65	2.56	17	0.67	39	1.54	22
1B156-6-6	G 3/8	10	3/8	67	2.64	17	0.67	42	1.65	22
1B156-8-8	G 1/2	13	1/2	77	3.03	20	0.79	48	1.89	27
1B156-12-12	G 3/4	19	3/4	99	3.9	25	1	65	2.56	32
1B156-16-16	G 1	25	1	127	5	31	1.22	79	3.11	41

1B256 - Female BSP Parallel Pipe Swivel 90° Elbow (60° Cone) ISO 228-1

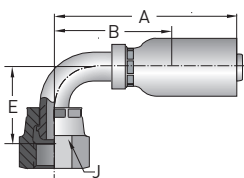

Construction: Steel. Add "C" for Stainless Steel.

Part Number	Thread Size	Hose I.D.		A		Cutoff Allow. B		E		J Hex
		mm	inch	mm	inch	mm	inch	mm	inch	mm
1B256-4-3	G 1/4	5	3/16	48	1.89	28	1.10	30	1.18	19
1B256-4-4	G 1/4	6	1/4	53	2.09	28	1.10	29	1.14	19
1B256-4-5	G 1/4	8	5/16	56	2.20	34	1.34	30	1.18	19
1B256-6-5	G 3/8	8	5/16	55	2.16	30	1.18	30	1.18	22
1B256-6-6	G 3/8	10	3/8	60	2.36	33	1.30	31	1.22	22
1B256-8-8	G 1/2	13	1/2	70	2.76	40	1.57	42	1.65	27
1B256-12-12	G 3/4	19	3/4	92	3.62	52	2.05	58	2.28	32
1B256-16-16	G 1	25	1	125	4.92	68	2.68	77	3.03	41

WARNING This product can expose you to chemicals including Lead, which is known to the State of California to cause cancer and birth defects or other reproductive harm. For more information go to www.P65Warnings.ca.gov.

Fittings - Permanent Crimp

56 Series

1C356 - Metric Female Swivel Nut Light Series, 24°/60°

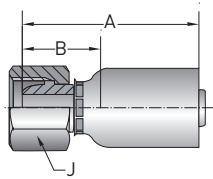

Construction: Steel. Add "C" for Stainless Steel.

Part Number	Thread Size	Hose I.D.		A		Cutoff Allow. B		J Hex mm
		mm	inch	mm	inch	mm	inch	
1C356-6-3	M12x1.5	5	3/16	37	1.46	20	0.79	14
1C356-8-4	M14x1.5	6	1/4	44	1.73	20	0.79	17
1C356-10-4	M16x1.5	6	1/4	45	1.77	21	0.83	19
1C356-10-5	M16x1.5	8	5/16	46	1.81	20	0.79	19
1C356-12-5	M18x1.5	8	5/16	47	1.85	21	0.83	22
1C356-10-6	M16x1.5	10	3/8	46	1.81	21	0.83	19
1C356-12-6	M18x1.5	10	3/8	47	1.85	21	0.83	22
1C356-15-6	M22x1.5	10	3/8	46	1.81	21	0.83	27
1C356-15-8	M22x1.5	13	1/2	50	1.97	21	0.83	27
1C356-18-10	M26x1.5	16	5/8	57	2.24	25	0.98	32
1C356-18-12	M26x1.5	19	3/4	58	2.28	24	0.94	32
1C356-22-12	M30x2	19	3/4	60	2.36	27	1.06	36

1C456 - Metric Female Swivel 45° Elbow Light Series, 24°/60°

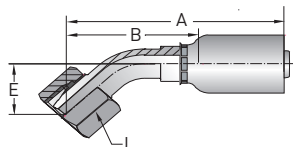

Construction: Steel. Add "C" for Stainless Steel.

Part Number	Thread Size	Hose I.D.		A		Cutoff Allow. B		E		J Hex mm
		mm	inch	mm	inch	mm	inch	mm	inch	
1C456-6-3	M12x1.5	5	3/16	57	2.24	40	1.57	16	0.63	14
1C456-8-4	M14x1.5	6	1/4	60	2.36	36	1.42	14	0.55	17
1C456-10-5	M16x1.5	8	5/16	62	2.44	37	1.46	15	0.59	19
1C456-10-6	M16x1.5	10	3/8	67	2.64	41	1.61	17	0.67	19
1C456-12-6	M18x1.5	10	3/8	72	2.83	47	1.85	18	0.71	22
1C456-15-8	M22x1.5	13	1/2	76	2.99	48	1.89	19	0.75	27

1C556 - Metric Female Swivel 90° Elbow Light Series, 24°/60°

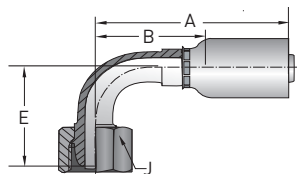

Construction: Steel. Add "C" for Stainless Steel.

Part Number	Thread Size	Hose I.D.		A		Cutoff Allow. B		E		J Hex mm
		mm	inch	mm	inch	mm	inch	mm	inch	
1C556-6-3	M12x1.5	5	3/16	48	1.89	30	1.18	30	1.18	14
1C556-8-4	M14x1.5	6	1/4	53	2.09	28	1.10	26	1.02	17
1C556-10-4	M16x1.5	6	1/4	53	2.09	28	1.10	27	1.06	19
1C556-12-5	M18x1.5	8	5/16	58	2.28	33	1.30	34	1.34	22
1C556-10-6	M16x1.5	10	3/8	63	2.48	38	1.50	33	1.30	19
1C556-12-6	M18x1.5	10	3/8	63	2.48	38	1.50	34	1.34	22
1C556-15-8	M22x1.5	13	1/2	72	2.83	44	1.73	39	1.54	27
1C556-18-12	M26x1.5	19	3/4	87	3.43	53	2.09	52	2.05	32



WARNING

This product can expose you to chemicals including Lead, which is known to the State of California to cause cancer and birth defects or other reproductive harm. For more information go to www.P65Warnings.ca.gov.

Fittings - Permanent Crimp

56 Series

1C656 - Female Metric Swivel DIN 20078 Heavy Series (Without O-ring) ISO 8434-1

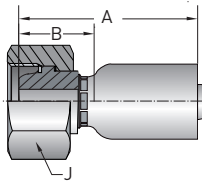

Construction: 316 Stainless nipple and shell.

Part Number	Thread Size	Hose I.D.		A		Cutoff Allow. B		J Hex inch
		inch	mm	inch	mm	inch	mm	
1C656-8-3	M16x1.5	5	3/16	38	1.50	20	0.79	19
1C656-10-4	M18x1.5	6	1/4	47	1.85	22	0.87	22
1C656-12-5	M20x1.5	8	5/16	50	1.97	24	0.94	24
1C656-12-6	M20x1.5	10	3/8	49	1.93	24	0.94	24
1C656-14-6	M22x1.5	10	3/8	49	1.93	23	0.89	27
1C656-16-8	M24x1.5	10	1/2	53	2.09	25	0.98	30
1C656-20-12	M30x2	13	3/4	61	2.40	27	1.06	36

1C956 - Female Metric Swivel DIN 20078 Heavy Series (With O-ring) ISO 12151-2-SWS

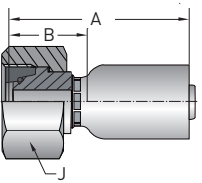

Construction: Steel. Add "C" for Stainless Steel.

Part Number	Thread Size	Hose I.D.		A		Cutoff Allow. B		E		J Hex mm
		mm	inch	mm	inch	mm	inch	mm	inch	
1C956-8-3	M16x1.5	5	3/16	41	1.61	23	0.91	19	1.542	19
1C956-8-4	M16x1.5	6	1/4	48	1.89	23	0.91	19	1.5	19
1C956-10-4	M18x1.5	6	1/4	48	1.89	23	0.91	22	1.54	22
1C956-12-4	M20x1.5	6	1/4	48	1.89	24	0.94	24	1.65	22
1C956-10-5	M18x1.5	8	5/16	49	1.93	23	0.91	22	1.5	19
1C956-12-5	M20x1.5	8	5/16	50	1.97	24	0.94	24	1.54	22
1C956-12-6	M20x1.5	10	3/8	49	1.93	24	0.94	24	1.65	22
1C956-14-6	M22x1.5	10	3/8	49	1.93	24	0.94	27	1.5	19
1C956-16-8	M24x1.5	10	1/2	56	2.17	27	1.06	30	1.54	22
1C956-20-12	M30x2	19	3/4	65	2.56	31	1.22	36	1.65	22
1C956-25-12	M36x2	19	3/4	66	2.6	32	1.3	46	3.11	41

NOTE: Nitrile O-ring.



WARNING

This product can expose you to chemicals including Lead, which is known to the State of California to cause cancer and birth defects or other reproductive harm. For more information go to www.P65Warnings.ca.gov.

Fittings - Permanent Crimp

56 Series

1CA56 – Metric Female Swivel 24° With O-ring Light Series ISO 12151-2-SWS

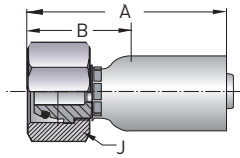

Construction: Steel. Add "C" for Stainless Steel.

Part Number	Thread Size	Hose I.D.		A		Cutoff Allow. B		J Hex mm
		mm	inch	mm	inch	mm	inch	
1CA56-6-3	M12x1.5	5	3/16	40	1.57	22	0.87	14
1CA56-6-4	M12x1.5	6	1/4	48	1.89	24	0.94	14
1CA56-8-4	M14x1.5	6	1/4	47	1.85	23	0.91	17
1CA56-10-4	M16x1.5	6	1/4	47	1.85	22	0.87	19
1CA56-12-4	M18x1.5	6	1/4	47	1.85	22	0.87	22
1CA56-10-5	M16x1.5	8	5/16	48	1.89	22	0.87	19
1CA56-12-5	M18x1.5	8	5/16	48	1.89	22	0.87	22
1CA56-10-6	M16x1.5	10	3/8	48	1.89	22	0.87	19
1CA56-12-6	M18x1.5	10	3/8	48	1.89	22	0.87	22
1CA56-15-6	M22x1.5	10	3/8	50	1.97	25	0.98	27
1CA56-12-8	M18x1.5	13	1/2	53	2.09	27	1.06	22
1CA56-15-8	M22x1.5	13	1/2	53	2.09	25	0.98	27
1CA56-18-8	M26x1.5	13	1/2	53	2.09	25	0.98	32
1CA56-18-10	M26x1.5	16	5/8	60	2.36	26	1.02	32
1CA56-18-12	M26x1.5	19	3/4	60	2.36	26	1.02	32
1CA56-22-12	M30x2	19	3/4	62	2.44	28	1.10	36
1CA56-28-16	M36x2	25	1	77	3.03	28	1.10	41

NOTE: Nitrile O-ring.

1CE56 – Metric Female Swivel 24° With O-ring 45° Elbow Light Series ISO 12151-2-SWE45

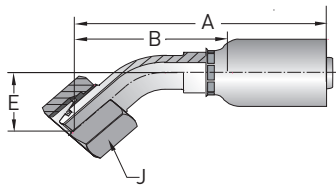

Construction: Steel. Add "C" for Stainless Steel.

Part Number	Thread Size	Hose I.D.		A		Cutoff Allow. B		E		J Hex mm
		mm	inch	mm	inch	mm	inch	mm	inch	
1CE56-6-3	M12x1.5	5	3/16	58	2.28	40	1.57	17	0.67	14
1CE56-8-4	M14x1.5	6	1/4	65	2.56	40	1.57	18	0.71	17
1CE56-10-4	M16x1.5	6	1/4	62	2.44	38	1.50	16	0.63	19
1CE56-10-5	M16x1.5	8	5/16	72	2.83	46	1.81	18	0.71	19
1CE56-10-6	M16x1.5	10	3/8	75	2.95	50	1.97	19	0.75	19
1CE56-12-6	M18x1.5	10	3/8	73	2.87	48	1.89	19	0.75	22
1CE56-15-8	M22x1.5	13	1/2	78	3.07	50	1.97	22	0.87	27
1CE56-18-10	M26x1.5	16	5/8	89	3.50	56	2.20	24	0.94	32
1CE56-18-12	M26x1.5	19	3/4	101	3.74	67	2.64	27	1.06	32
1CE56-22-12	M30x2	19	3/4	100	3.94	66	2.60	26	1.02	36
1CE56-28-16	M36x2	25	1	133	5.27	85	3.35	33	1.30	41

NOTE: Nitrile O-ring.



WARNING

This product can expose you to chemicals including Lead, which is known to the State of California to cause cancer and birth defects or other reproductive harm. For more information go to www.P65Warnings.ca.gov.

Fittings - Permanent Crimp

56 Series

1CF56 - Metric Female Swivel 24° With O-ring 90° Elbow Light Series ISO 12151-2-SWE90

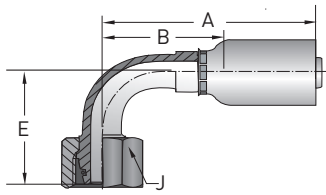

Construction: Steel. Add "C" for Stainless Steel.

Part Number	Thread Size	Hose I.D.		A		Cutoff Allow. B		E		J Hex
		mm	inch	mm	inch	mm	inch	mm	inch	mm
1CF56-6-3	M12x1.5	5	3/16	48	1.89	30	1.18	30	1.18	14
1CF56-6-4	M12x1.5	6	1/6	53	2.09	29	1.14	33	1.3	14
1CF56-8-4	M14x1.5	6	1/6	55	2.17	30	1.18	29	1.14	17
1CF56-10-4	M16x1.5	6	1/6	55	2.17	31	1.22	29	1.14	17
1CF56-10-5	M16x1.5	8	5/16	66	2.6	40	1.57	29	1.14	19
1CF56-12-5	M18x1.5	8	5/16	65	2.56	40	1.57	30	1.18	22
1CF56-10-6	M16x1.5	10	3/8	64	2.52	39	1.54	37	1.46	19
1CF56-12-6	M18x1.5	10	3/8	63	2.48	38	1.5	35	1.38	22
1CF56-15-8	M22x1.5	13	1/2	68	2.68	40	1.57	43	1.69	27
1CF56-18-10	M26x1.5	16	5/8	79	3.11	45	1.77	52	2.05	32
1CF56-22-12	M30x2	19	3/4	91	3.58	57	2.24	55	2.17	36
1CF56-28-16	M36x2	25	1	122	50	74	2.91	71	2.8	41

NOTE: Nitrile O-ring.

1FU56 - (JIS) /BSP 30° Flare Swivel Female

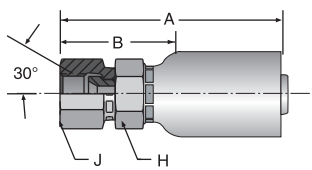

Construction: Steel. Add "C" for Stainless Steel.

Part Number	Thread Size	Hose I.D.		A		Cutoff Allow. B		H Hex	J Hex
		inch	mm	inch	mm	inch	mm	mm	mm
1FU56-4-4	G 1/4-19	1/4	6	2.19	56	1 1/4	31	19	19
1FU56-6-6	G 3/8-19	3/8	10	2.36	60	1 3/8	35	22	22
1FU56-8-8	G 1/2-14	1/2	13	2.68	68	1 9/16	40	27	27
1FU56-12-12	G 3/4-14	3/4	19	3.02	77	1 11/16	43	36	36
1FU56-16-16	G 1-11	1	25	3.76	96	1 7/8	48	41	41

WARNING This product can expose you to chemicals including Lead, which is known to the State of California to cause cancer and birth defects or other reproductive harm. For more information go to www.P65Warnings.ca.gov.

Fittings - Permanent Crimp

56 Series

1D056 - Male Stud DIN 20078 Light Series ISO 8434-1

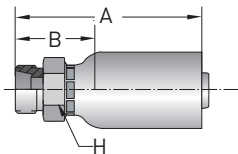

Construction: Steel. Add "C" for Stainless Steel.

Part Number	Thread Size	Hose I.D.		A		Cutoff Allow. B		H Hex mm
		mm	inch	mm	inch	mm	inch	
1D056-6-3	M12x1.5	5	3/16	41	1.61	23	0.91	12
1D056-6-4	M12x1.5	6	1/4	48	1.89	23	0.91	12
1D056-8-4	M14x1.5	6	1/4	47	1.85	23	0.91	14
1D056-10-5	M16x1.5	8	5/16	50	1.97	24	0.94	17
1D056-12-5	M18x1.5	8	5/16	52	2.05	26	1.02	19
1D056-10-6	M16x1.5	10	3/8	50	1.97	24	0.94	17
1D056-12-6	M18x1.5	10	3/8	50	1.97	24	0.94	19
1D056-15-6	M22x1.5	10	3/8	52	2.05	27	1.06	22
1D056-15-8	M22x1.5	13	1/2	55	2.16	27	1.06	22
1D056-18-10	M26x1.5	16	5/8	64	2.52	30	1.18	27
1D056-22-12	M30x2	19	3/4	68	2.68	34	1.34	30
1D056-28-16	M36x2	25	1	82	3.23	34	1.34	36

1D256 - Metric Male Stud 24° Heavy Series ISO 12151-2

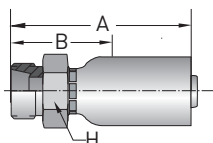

Construction: Steel. Add "C" for Stainless Steel.

Part Number	Thread Size	Hose I.D.		A		Cutoff Allow. B		H Hex mm
		mm	inch	mm	inch	mm	inch	
1D256-8-3	M16x1.5	5	3/16	42	1.65	25	0.98	12
1D256-10-4	M18x1.5	6	1/4	52	2.05	27	1.06	12
1D256-10-5	M18x1.5	8	5/16	53	2.09	27	1.06	14
1D256-12-5	M20x1.5	8	5/16	53	2.09	27	1.06	17
1D256-12-6	M20x1.5	10	3/8	53	2.09	27	1.06	19
1D256-14-6	M22x1.5	10	3/8	57	2.24	31	1.22	17
1D256-16-6	M24x1.5	10	3/8	57	2.24	31	1.22	19
1D256-16-8	M24x1.5	13	1/2	60	2.36	31	1.22	22
1D256-20-12	M30x2	19	3/4	72	2.83	38	1.50	22

1D956 Male BSPP - Straight (60° Cone) ISO 228-1

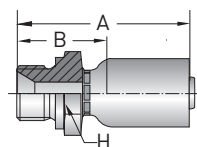

Construction: Steel. Add "C" for Stainless Steel.

Part Number	Thread Size	Hose I.D.		A		Cutoff Allow. B		H Hex mm
		mm	inch	mm	inch	mm	inch	
1D956-4-3	G 1/4	5	3/16	44	1.73	27	1.06	19
1D956-4-4	G 1/4	6	1/4	52	2.05	27	1.06	19
1D956-6-5	G 3/8	8	5/16	53	2.09	27	1.06	22
1D956-6-6	G 3/8	10	3/8	53	2.09	28	1.10	22
1D956-8-8	G 1/2	13	1/2	60	2.36	32	1.26	27
1D956-12-12	G 3/4	19	3/4	75	2.95	41	1.61	32
1D956-16-16	G 1	25	1	91	3.58	42	1.65	41



WARNING

This product can expose you to chemicals including Lead, which is known to the State of California to cause cancer and birth defects or other reproductive harm. For more information go to www.P65Warnings.ca.gov.

Fittings - Permanent Crimp

56 Series Rapid Assembly

1WU56 Male Rapid Assembly Straight

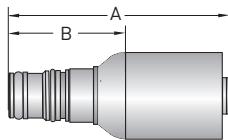

Part Number	Stem O.D.		Hose I.D.		A		Cutoff Allow. B	
	inch	mm	inch	mm	inch	mm	inch	mm
1WU56-4-4	1/4	6	1/4	6	2.18	55	1-1/8	29
1WU56-6-6	3/8	10	3/8	10	2.30	58	1-3/16	30

NOTE: Use with mating adapter PN 685RA.

Construction: Steel. Nitrile O-ring.

1WW56 Male Rapid Assembly 45° Elbow

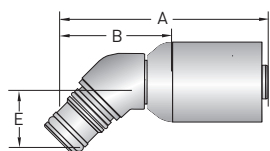

Part Number	Stem O.D.		Hose I.D.		A		Cutoff Allow. B		E	
	inch	mm	inch	mm	inch	mm	inch	mm	inch	mm
1WW56-4-4	1/4	6	1/4	6	2.31	59	1-5/16	33	0.67	17
1WW56-6-6	3/8	10	3/8	10	2.35	60	1-3/8	35	0.67	17

NOTE: Use with mating adapter PN 685RA.

Construction: Steel. Nitrile O-ring.

1WY56 Male Rapid Assembly 90° Elbow

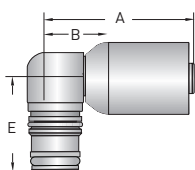

Part Number	Stem O.D.		Hose I.D.		A		Cutoff Allow. B		E	
	inch	mm	inch	mm	inch	mm	inch	mm	inch	mm
1WY56-4-4	1/4	6	1/4	6	1.60	41	5/8	16	0.90	23
1WY56-6-6	3/8	10	3/8	10	1.66	42	5/8	16	1.01	26

NOTE: Use with mating adapter PN 685RA.

Construction: Steel. Nitrile O-ring.

685RA Adapter Female Rapid Assembly - Male SAE Straight Thread ORB

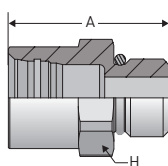









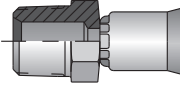
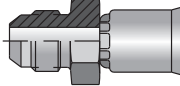
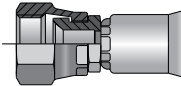
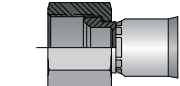
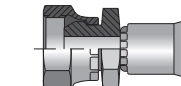
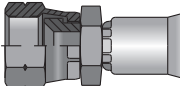
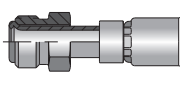
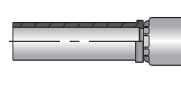
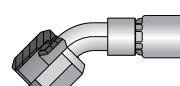
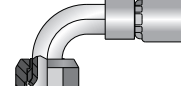
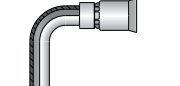
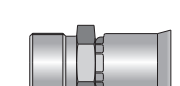

Part Number	Stem O.D.		Thread Size	A		H Hex inch
	inch	mm		inch	mm	
685RA-4-4	1/4	6	7/16-20	1.05	27	11/16
685RA-6-4	3/8	10	7/16-20	1.15	29	3/4
685RA-4-6	1/4	6	9/16-18	1.12	28	3/4
685RA-6-6	3/8	10	9/16-18	1.15	29	3/4

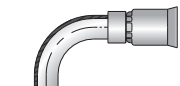
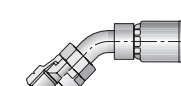
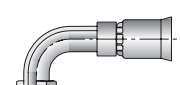
Construction: Steel. Nitrile O-ring.

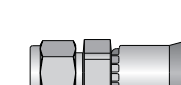
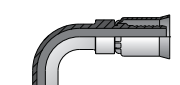
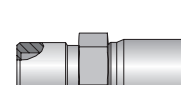
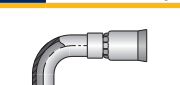
WARNING This product can expose you to chemicals including Lead, which is known to the State of California to cause cancer and birth defects or other reproductive harm. For more information go to www.P65Warnings.ca.gov.

Fittings - Permanent Crimp

91N Series

91N Series Permanent	101 Male Taper Pipe Rigid	103 Male JIC 37°	106 JIC 37° Female Swivel	106RD SAE JIC 37° Swivel	107 Female Pipe Swivel
					
	E-52	E-52	E-52	E-53	E-53
	108 Female SAE 45° Swivel	128 Male Inverted Swivel Straight	134 Straight Tube	137 Female JIC 37° Swivel 45° Elbow	139 FM JIC 37° Swivel 90° Elbow Short
					
	E-53	E-54	E-54	E-54	E-55
	141 Female JIC 37° Swivel 90° Elb Long	161 Compression Air Brake	167 Male Inverted Swivel 45° Elbow	169 Male Inverted Swivel 90° Elbow	177 SAE 45° Swivel 45° Elbow
					
	E-55	E-55	E-56	E-56	E-56
	179 SAE 45° Swivel 90° Elbow	192 FM BSP Pipe Swivel - Str. (60° Cone)	1AL A-Lok® Compression	1B2 FM BSP Pipe Swivel 90° Elb. (60° Cone)	1GK Bulkhead w/Zerk Port Integrated
					
E-57	E-60	E-57	E-60	E-60	
1J1 Female Seal-Lok™ 90° Elbow Long	1J7 Female Seal-Lok™ 45° Elbow	1J9 Female Seal-Lok™ 90° Elbow Short	1JC Female Seal-Lok™ Swivel Straight	1P6 CPI® Compression w/nut and ferrule	
					
E-58	E-58	E-59	E-59	E-57	
1TU Universal Tube Stub					
					
E-59					

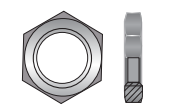
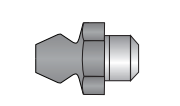
1GK91N Options	Nut 2GK-Nut	Zerk NA-6520
		
	E-60	E-60

WARNING
 This product can expose you to chemicals including Lead, which is known to the State of California to cause cancer and birth defects or other reproductive harm. For more information go to www.P65Warnings.ca.gov.

Fittings - Permanent Crimp

91N Series

10191N Male Taper Pipe Rigid

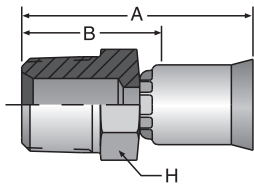

Construction: Brass nipple, steel shell. Add "C" for Stainless Steel.

Part Number	Thread Size	Hose Size inch	A		Cutoff Allow. B		H Hex inch
			inch	mm	inch	mm	
10191N-2-4	1/8-27	-4	1.27	32	3/4	19	7/16
10191N-4-4	1/4-18	-4	1.50	38	15/16	24	9/16
10191N-4-5	1/4-18	-5	1.55	39	15/16	24	9/16
10191N-4-6	1/4-18	-6	1.60	41	15/16	24	9/16
10191N-6-6	3/8-18	-6	1.65	58	1	25	11/16
10191N-6-8	3/8-18	-8	1.71	43	1	25	11/16
10191N-8-8	1/2-14	-8	1.94	49	1-1/4	32	7/8
10191N-8-10	1/2-14	-10	1.96	50	1-1/4	32	7/8
10191N-8-12	1/2-14	-12	2.42	61	1-1/4	32	1
10191N-12-12	3/4-14	-12	2.19	56	1-3/8	35	1-1/8
10191N-16-16	1-11-1/2	-16	2.46	62	1-1/2	38	1-3/8
10191-20-20	1-1/4-11-1/2	-20	3.05	77	2-1/16	52	1-3/4

10391N Male (JIC) 37°

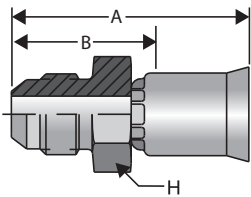

Construction: Steel nipple, steel shell. Add "C" for Stainless Steel.

Part Number	Thread Size	Hose Size inch	A		Cutoff Allow. B		H Hex inch
			inch	mm	inch	mm	
10391N-4-4	7/16-20	-4	1.37	35	13/16	21	1/2
10391N-6-6	9/16-18	-6	1.64	42	1	25	11/16
10391N-8-8	3/4-16	-8	1.79	35	1-1/8	29	7/8
10391N-8-6	3/4-16	-6	1.73	44	1-1/16	27	7/8
10391N-10-10	7/8-14	-10	2.07	53	1-3/8	35	1
10391N-12-12	1-1/16-12	-12	2.10	53	1-5/16	33	1-1/8
10391N-16-16	1-5/16-12	-16	2.43	62	1-1/2	38	1-3/8

10691N Female SAE (JIC) 37° Swivel

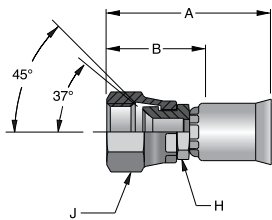

Construction: Brass nipple, steel nut and shell. Add "S" for Steel nipple, nut and shell. Add "C" for Stainless Steel.

Part Number	Thread Size	Hose Size inch	A		Cutoff Allow. B		H Hex inch	J Hex inch
			inch	mm	inch	mm		
10691N-4-4	7/16-20	-4	1.47	37	7/8	22	3/8	9/16
10691N-5-5	1/2-20	-5	1.60	41	1	25	7/16	5/8
10691N-6-6	9/16-18	-6	1.66	42	1	25	1/2	11/16
10691N-6-8	9/16-18	-8	1.72	44	1	25	9/16	11/16
10691N-8-8	3/4-16	-8	1.89	48	1-3/16	30	11/16	7/8
10691N-8-10	3/4-16	-10	1.86	58	1-1/8	29	3/4	7/8
10691N-10-10	7/8-14	-10	2.03	52	1-5/16	33	13/16	1
10691N-12-12	1-1/16-12	-12	2.18	55	1-3/8	35	1	1-1/4
10691N-16-16	1-5/16-12	-16	2.45	62	1-9/16	40	1-1/4	1-1/2
10691-20-20	1-5/8-12	-20	2.66	68	1-5/8	42	1-11/16	2

NOTE: Size -4, -5, -8 and -10 incorporate a dual seat.



WARNING

This product can expose you to chemicals including Lead, which is known to the State of California to cause cancer and birth defects or other reproductive harm. For more information go to www.P65Warnings.ca.gov.

Fittings - Permanent Crimp

91N Series

10691NRD SAE (JIC) 37° Swivel

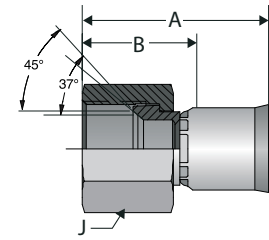

Construction: Brass nipple, steel nut and shell. Add "C" for Stainless Steel.

Part Number	Thread Size	Hose Size inch	A		Cutoff Allow. B		J Hex inch
			inch	mm	inch	mm	
10691N-4-4-RD	7/16-20	-4	1.34	34	13/16	21	9/16
10691N-5-5-RD	1/2-20	-5	1.52	39	15/16	24	5/8
10691N-6-6-RD	9/16-18	-6	1.61	41	1	25	11/16
10691N-8-8-RD	3/4-16	-8	1.77	45	1-1/16	27	7/8
10691N-10-10-RD	7/8-14	-10	1.91	49	1-3/16	30	1
10691N-12-12-RD	1-1/16-12	-12	2.09	52	1-5/16	33	1-1/4
10691N-16-16-RD	1-5/16-12	-16	2.30	58	1-3/8	35	1-1/2

NOTE: Size -4, -5, -8 and -10 incorporate a dual seat.

10791N Female Pipe Swivel

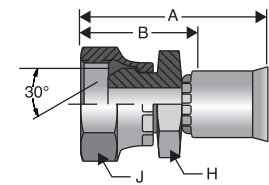

Construction: Brass nipple, steel nut and shell. Add "C" for Stainless Steel.

Part Number	Thread Size	Hose Size inch	A		Cutoff Allow. B		H Hex inch	J Hex inch
			inch	mm	inch	mm		
10791N-4-4	1/4-18	-4	1.54	39	1	25	9/16	11/16
10791N-6-6	3/8-18	-6	1.59	40	15/16	24	5/8	7/8
10791N-8-8	1/2-14	-8	1.83	46	1-1/8	29	3/4	1
10791N-12-12	3/4-14	-12	2.09	53	1-5/16	33	1	1-1/4
10791N-16-16	1-11-1/2	-16	2.35	59	1-7/16	33	1-3/16	1-1/2

10891N SAE 45° Swivel

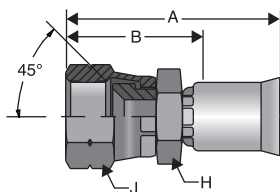

Construction: Brass nipple, steel nut and shell. Add "C" for Stainless Steel.

Part Number	Thread Size	Hose Size inch	A		Cutoff Allow. B		H Hex inch	J Hex inch
			inch	mm	inch	mm		
10891N-6-6	5/8-18	-6	1.74	44	1-1/8	29	5/8	3/4
10891N-12-12	1-1/16-14	-12	2.18	55	1-3/8	35	1	1-1/4



WARNING

This product can expose you to chemicals including Lead, which is known to the State of California to cause cancer and birth defects or other reproductive harm. For more information go to www.P65Warnings.ca.gov.

Fittings - Permanent Crimp

91N Series

12891N Male Inverted Swivel-Straight

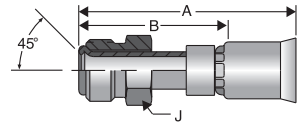

Construction: Steel nipple, tube, nut and shell. Add "C" for Stainless Steel.

Part Number	Thread Size	Hose Size inch	A		Cutoff Allow. B		J Hex inch
			inch	mm	inch	mm	
12891N-4-4	7/16-24	-4	2.09	53	1-1/2	38	7/16
12891N-5-5	1/2-20	-5	2.15	55	1-9/16	40	1/2
12891N-5-6	1/2-20	-6	2.23	57	1-9/16	40	1/2
12891N-6-6	5/8-18	-6	2.23	57	1-9/16	40	5/8
12891N-8-8	3/4-18	-8	2.31	59	1-5/8	41	3/4
12891N-10-10	7/8-18	-10	2.43	58	1-3/4	44	7/8
12891N-12-12	1-1/16-16	-12	2.50	64	1-11/16	43	1-1/16

13491N Straight Tube

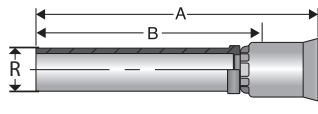

Construction: Brass nipple, steel shell.

Part Number	Hose Size	Diameter R inch	A		Cutoff Allow. B	
			inch	mm	inch	mm
13491N-8-8	-8	1/2	2.80	71	2-1/8	54
13491N-8-10	-10	1/2	2.81	71	2-1/8	54
13491N-10-10	-10	5/8	2.96	75	2-1/4	58
13491N-12-12	-12	3/4	3.37	86	2-9/16	65

NOTE: The 16T91N fitting includes 13491N with the 60HAB sleeve and 61HAB nut.

13791N JIC 37° Swivel 45° Elbow

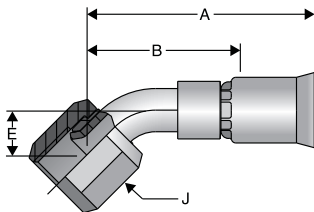

Construction: Steel nipple, tube, nut and shell. Add "C" for Stainless Steel.

Part Number	Thread Size	Hose Size inch	A		Cutoff Allow. B		E		J Hex inch
			inch	mm	inch	mm	inch	mm	
13791N-4-4	7/16-20	-4	1.74	44	1-3/16	30	0.33	8	9/16
13791N-5-5	1/2-20	-5	1.87	47	1-1/4	32	0.36	9	5/8
13791N-6-6	9/16-18	-6	1.94	49	1-5/16	33	0.43	11	11/16
13791N-8-8	3/4-16	-8	2.28	58	1-9/16	37	0.55	14	7/8
13791N-10-10	7/8-14	-10	2.42	61	1-11/16	43	0.64	43	1
13791N-12-12	1-1/16-12	-12	2.83	58	2-1/16	52	0.78	20	1-1/4
13791N-16-16	1-5/16-12	-16	3.18	81	2-1/4	57	0.89	23	1-1/2
13791-20-20	1-5/8-12	-20	3.67	93	2-9/16	65	1.10	28	2



WARNING

This product can expose you to chemicals including Lead, which is known to the State of California to cause cancer and birth defects or other reproductive harm. For more information go to www.P65Warnings.ca.gov.

Fittings - Permanent Crimp

91N Series

13991N JIC 37° Swivel 90° Elbow Short Drop

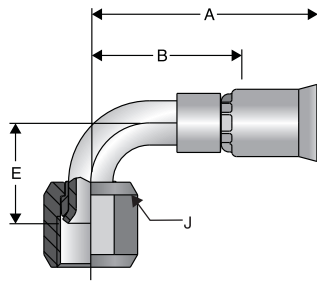

Construction: Steel nipple, tube, nut and shell. Add "C" for Stainless Steel.

Part Number	Thread Size	Hose Size inch	A		Cutoff Allow. B		E		J Hex inch
			inch	mm	inch	mm	inch	mm	
13991N-4-4	7/16-20	-4	1.62	41	1-1/16	37	0.68	17	9/16
13991N-5-5	1/2-20	-5	1.73	44	1-1/8	29	0.77	20	5/8
13991N-6-6	9/16-18	-6	1.91	49	1-1/4	32	0.91	23	11/16
13991N-8-8	3/4-16	-8	2.03	52	1-5/16	33	1.09	28	7/8
13991N-10-10	7/8-14	-10	2.27	58	1-9/16	37	1.23	43	1
13991N-12-12	1-1/16-12	-12	2.75	58	1-15/16	49	1.82	46	1-1/2
13991N-16-16	1-5/8-12	-16	3.15	80	2-3/16	56	2.14	52	1-1/2
13991-20-20	1-5/8-12	-20	3.53	90	2-7/16	62	1.18	30	2

14191N JIC 37° Swivel 90° Elbow Long Drop

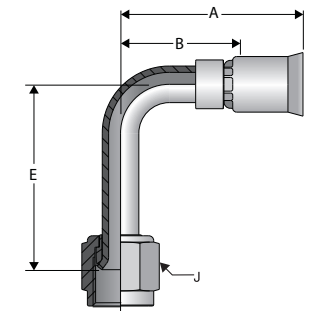

Construction: Steel nipple, tube, nut and shell. Add "C" for Stainless Steel.

Part Number	Thread Size	Hose Size inch	A		Cutoff Allow. B		E		J Hex inch
			inch	mm	inch	mm	inch	mm	
14191N-4-4	7/16-20	-4	1.66	42	1-1/8	29	1.80	46	9/16
14191N-5-5	1/2-20	-5	1.72	44	1-1/8	29	1.77	45	5/8
14191N-6-6	9/16-18	-6	1.93	49	1-5/16	33	2.13	54	11/16
14191N-8-8	3/4-16	-8	2.11	54	1-3/8	35	2.52	64	7/8
14191N-10-10	7/8-14	-10	2.34	59	1-5/8	41	2.57	65	1
14191N-12-12	1-1/16-12	-12	2.63	67	1-7/8	48	3.73	95	1-1/4
14191N-16-16	1-5/8-12	-16	3.15	80	2-3/16	56	4.33	110	1-1/2
14191-20-20	1-5/8-12	-20	4.00	102	2-15/16	75	5.28	134	2

16191N Compression Air Brake

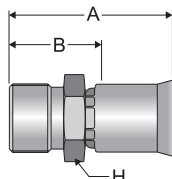

Construction: Brass nipple, steel shell.

Part Number	Thread Size	Hose Size inch	A		Cutoff Allow. B		H Hex inch
			inch	mm	inch	mm	
16191N-8-8	11/16-20	-8	1.61	41	15/16	24	3/4
16191N-8-10	11/16-20	-10	1.61	41	15/16	24	7/8
16191N-10-10	13/16-18	-10	1.82	46	1-1/8	29	15/16
16191N-12-12	1-18	-12	1.93	49	1-1/8	29	1-1/4



WARNING

This product can expose you to chemicals including Lead, which is known to the State of California to cause cancer and birth defects or other reproductive harm. For more information go to www.P65Warnings.ca.gov.

Fittings - Permanent Crimp

91N Series

16791N Male Inverted Swivel 45° Elbow

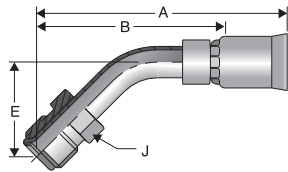

Construction: Steel nipple, tube, nut and shell. Add "C" for Stainless Steel.

Part Number	Thread Size	Hose Size inch	A		Cutoff Allow. B		E		J Hex inch
			inch	mm	inch	mm	inch	mm	
16791N-4-4	7/16-24	-4	2.05	52	1-1/2	38	0.63	16	7/16
16791N-5-5	1/2-20	-5	2.48	63	1-7/8	48	0.71	18	1/2
16791N-6-6	5/8-18	-6	2.60	66	1-15/16	49	0.96	24	5/8
16791N-8-8	3/4-18	-8	2.85	72	2-1/8	54	0.90	23	3/4
16791N-10-10	7/8-18	-10	3.30	84	2-5/8	67	1.02	43	7/8
16791N-12-12	1-1/16-16	-12	3.64	58	2-13/16	71	1.15	29	1-1/16

16991N Male Inverted Swivel 90° Elbow

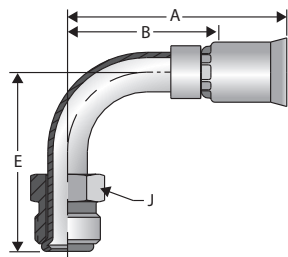

Construction: Steel nipple, tube, nut and shell. Add "C" for Stainless Steel.

Part Number	Thread Size	Hose Size inch	A		Cutoff Allow. B		E		J Hex inch
			inch	mm	inch	mm	inch	mm	
16991N-4-4	7/16-24	-4	1.72	44	1-3/16	30	1.19	30	7/16
16991N-5-5	1/2-20	-5	1.98	50	1-3/8	35	1.65	42	1/2
16991N-5-6	1/2-20	-6	2.03	52	1-7/16	37	1.65	42	1/2
16991N-6-6	5/8-18	-6	2.08	53	1-7/16	37	1.70	43	5/8
16991N-8-8	3/4-18	-8	2.18	55	1-1/2	38	1.87	43	3/4
16991N-10-10	7/8-18	-10	3.02	58	2-5/16	59	2.18	55	7/8
16991N-12-12	1-1/16-16	-12	3.36	85	2-9/16	64	2.51	64	1-1/16

17791N SAE 45° Swivel 45° Elbow

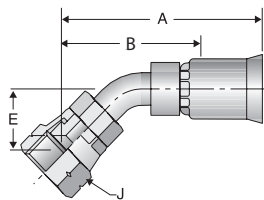

Construction: Steel nipple, tube, nut and shell. Add "C" for Stainless Steel.

Part Number	Thread Size	Hose Size inch	A		Cutoff Allow. B		E		J Hex inch
			inch	mm	inch	mm	inch	mm	
17791N-6-6	5/8-18	3/8	2.06	52	1-5/16	33	0.39	10	3/4
17791N-12-12	1-1/16-14	3/4	3.07	78	2-7/16	62	0.78	20	1-1/4

WARNING This product can expose you to chemicals including Lead, which is known to the State of California to cause cancer and birth defects or other reproductive harm. For more information go to www.P65Warnings.ca.gov.

Fittings - Permanent Crimp

91N Series

17991N SAE 45° Swivel 90° Elbow

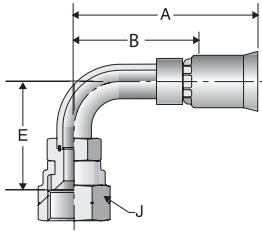

Construction: Steel nipple, tube, nut and shell. Add "C" for Stainless Steel.

Part Number	Thread Size	Hose Size inch	A		Cutoff Allow. B		E		J Hex inch
			inch	mm	inch	mm	inch	mm	
17991N-6-6	5/8-18	3/8	2.06	52	1-5/16	49	1.19	30	3/4
17991N-12-12	1-1/16-14	3/4	2.92	74	2-1/8	54	1.82	46	1-1/4

1AL91N A-LOK® Compression

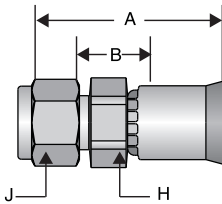

Construction: Stainless steel nipple and shell.

Part Number w/nut & ferrule	Part Number w/o nut & ferrules	Hose Size inch	A		Cutoff Allow. B		H Hex inch	J Hex inch
			inch	mm	inch	mm		
1AL91N-4-4C	1AL91N-4-4NC	-4	1.28	33	7/16	11	1/2	9/16
1AL91N-4-5C	1AL91N-4-5NC	-5	1.36	35	7/16	11	1/2	9/16
1AL91N-6-6C	1AL91N-6-6NC	-6	1.46	37	7/16	11	3/4	11/16
1AL91N-8-8C	1AL91N-8-8NC	-8	1.61	41	7/16	11	13/16	7/8
1AL91N-12-12C	1AL91N-12-12NC	-12	1.86	47	1/2	13	1-1/8	1-1/8
1AL91N-16-16C	1AL91N-16-16NC	-16	2.12	54	7/16	11	1-3/8	1-1/2

NOTE: Nuts and Ferrules are Manufactured by the Instrumentation Products Division. Refer to Catalog 4230/4233 for information.

Nut part No. is XNUX-316. Ferrule part No. is XFFX-316. X denotes dash size.

1P691N CPI® Compression (With Nut and Ferrule)

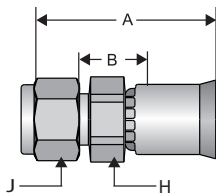

Construction: Stainless steel nipple and shell.

Part Number w/nut & ferrule	Hose Size inch	A		Cutoff Allow. B		H Hex inch	J Hex inch
		inch	mm	inch	mm		
1P691N-4-4C	-4	1.30	33	7/16	11	1/2	9/16
1P691N-6-6C	-6	1.53	39	1/2	13	5/8	11/16
1P691N-8-8C	-8	1.61	41	7/16	11	13/16	7/8

NOTE: Nuts and Ferrules are Manufactured by the Instrumentation Products Division. Refer to Catalog 4230/4233 for information.

Nut part No. is XBZ-SS. Ferrule part No. is XTZ-SS. X denotes dash size.



WARNING

This product can expose you to chemicals including Lead, which is known to the State of California to cause cancer and birth defects or other reproductive harm. For more information go to www.P65Warnings.ca.gov.

Fittings - Permanent Crimp

91N Series

1J191N Female Seal-Lok™ Swivel 90° Elbow Long Drop

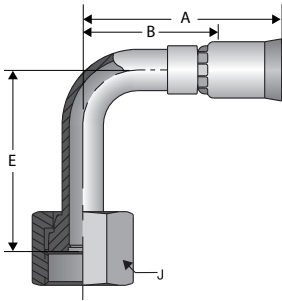

Construction: Steel nipple, tube, nut and shell. Add "C" for Stainless Steel.

Part Number	Thread Size	Hose Size inch	A		Cutoff Allow. B		E		J Hex inch
			inch	mm	inch	mm	inch	mm	inch
1J191N-4-4	9/16-18	-4	1.66	42	1-1/16	27	1.8	46	11/16
1J191N-4-5	9/16-18	-5	1.78	45	1-1/16	27	1.8	46	11/16
1J191N-6-5	11/16-16	-5	1.92	49	1-3/16	30	2.13	54	13/16
1J191N-6-6	11/16-16	-6	1.92	49	1-3/16	30	2.13	54	13/16
1J191N-8-6	13/16-16	-6	2	51	1-9/16	40	2.51	43	15/16
1J191N-8-8	13/16-16	-8	2.15	58	1-7/16	37	2.51	64	15/16
1J191N-10-10	1-14	-10	1.25	32	1-9/16	40	2.76	70	1-1/8
1J191N-12-12	1-3/16-12	-12	2.65	67	1-13/16	46	3.78	96	1-3/8
1J191N-16-16	1-7/16-12	-16	3.15	80	2-1/4	57	4.5	114	1-1/2

1J791N Female Seal-Lok™ Swivel 45° Elbow

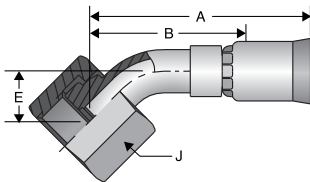

Construction: Steel nipple, tube, nut and shell. Add "C" for Stainless Steel.

Part Number	Thread Size	Hose Size inch	A		Cutoff Allow. B		E		J Hex inch
			inch	mm	inch	mm	inch	mm	inch
1J791N-4-4	9/16-18	-4	1.73	44	1-1/4	32	0.41	10	11/16
1J791N-4-6	9/16-18	-6	1.91	49	1-5/16	33	0.41	10	11/16
1J791N-6-6	11/16-16	-6	2.02	51	1-3/8	35	0.43	11	13/16
1J791N-8-8	13/16-16	-8	2.18	55	1-1/2	38	0.59	15	15/16
1J791N-8-10	13/16-16	-10	2.39	61	1-11/16	43	0.59	15	15/16
1J791N-10-10	1-14	-10	2.47	63	1-3/4	44	0.59	43	1-1/8
1J791N-12-12	1-3/16-12	-12	2.74	58	1-15/16	49	0.81	21	1-3/8
1J791N-16-16	1-7/16-12	-16	3.50	89	2-1/2	64	0.94	24	1-5/8



WARNING

This product can expose you to chemicals including Lead, which is known to the State of California to cause cancer and birth defects or other reproductive harm. For more information go to www.P65Warnings.ca.gov.

Fittings - Permanent Crimp

91N Series

1J991N Female Seal-Lok™ Swivel 90° Elbow Short Drop

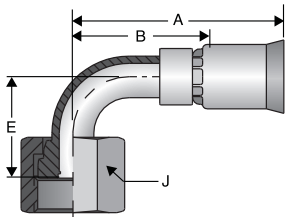

Construction: Steel nipple, tube, nut and shell. Add "C" for Stainless Steel.

Part Number	Thread Size	Hose Size inch	A		Cutoff Allow. B		E		J Hex inch
			inch	mm	inch	mm	inch	mm	
1J991N-4-4	9/16-18	-4	1.73	44	1-1/4	32	0.82	21	11/16
1J991N-6-6	11/16-16	-6	1.91	49	1-5/16	33	0.91	23	13/16
1J991N-8-8	13/16-16	-8	2.02	51	1-3/8	35	1.15	29	15/16
1J991N-10-10	1-14	-10	2.18	55	1-1/2	38	1.27	32	1-1/8
1J991N-12-12	1-3/16-12	-12	2.39	61	1-11/16	43	1.85	43	1-3/8
1J991N-16-16	1-7/16-12	-16	2.47	63	1-3/4	44	2.21	56	1-5/8

1JC91N Female Seal-Lok™ Swivel Straight

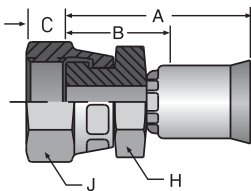

Construction: Steel nipple, tube, nut and shell. Add "C" for Stainless Steel.

Part Number	Thread Size	Hose Size inch	A		Cutoff Allow. B		C		H Hex inch	J Hex inch
			inch	mm	inch	mm	inch	mm		
1JC91N-4-4	9/16-18	-4	1.46	37	5/8	16	.32	8	9/16	7/16
1JC91N-6-6	11/16-16	-6	1.62	41	11/16	17	.32	8	5/8	1/2
1JC91N-8-8	13/16-16	-8	1.93	49	13/16	21	.43	11	3/4	5/8
1JC91N-12-10	1-3/16-12	-10	2.05	52	1-1/4	32	.57	14	15/16	7/8
1JC91N-12-10	1-3/16-12	-10	2.05	52	1-1/4	32	.57	14	15/16	7/8
1JC91N-12-12	1-3/16-12	-12	2.05	58	1-1/4	32	.57	14	15/16	3/4
1JC91N-16-16	1-7/16-12	-16	2.56	65	1-1/16	27	.58	15	1-3/8	7/8
1JC91N-20-16	1-11/16-12	-16	2.30	58	1-3/8	35	.59	15	1-5/8	1-1/16
1JC91-20-20	1-11/16-12	-20	2.68	68	1-11/16	43	.59	15	1-11/16	7/8

NOTE: When measuring overall length to the end of the nut, B+C dimensions must be used to calculate cut-off allowance.

1TU91N Universal Tube Stub

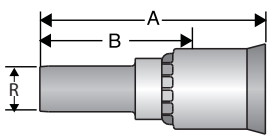

Construction: Stainless steel tube and shell.

Part Number	Hose Size	Diameter R inch	A		Cutoff Allow. B	
			inch	mm	inch	mm
1TU91N-4-4C	-4	1/4	1.63	41	1-1/16	27
1TU91N-4-5C	-5	1/4	1.70	43	1-1/16	27
1TU91N-6-6C	-6	3/8	1.81	46	1-3/16	30
1TU91N-8-8C	-8	1/2	2.72	58	1-7/16	37
1TU91N-8-10C	-10	1/2	2.14	54	1-7/16	37
1TU91N-10-10C	-10	5/8	2.14	54	1-7/16	37
1TU91N-12-12C	-12	3/4	2.24	57	1-7/16	37
1TU91N-16-16C	-16	1	2.73	69	1-3/4	44

NOTE: Use with A-Lok & CPI nuts, sleeves and adapters. These components are manufactured by Parker's Instrumentation Connectors Division. Refer to catalog 4230/4233 for information.



WARNING

This product can expose you to chemicals including Lead, which is known to the State of California to cause cancer and birth defects or other reproductive harm. For more information go to www.P65Warnings.ca.gov.

Fittings - Permanent Crimp

91N Series

19291N Female BSP Parallel Pipe Swivel Straight (60° Cone)

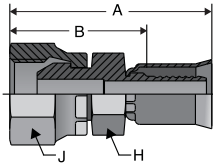

Construction: Steel nipple, tube, nut and shell. Add "C" for Stainless Steel.

Part Number	Thread Size	Hose Size inch	A		Cutoff Allow. B		H Hex mm	J Hex mm
			inch	mm	inch	mm		
19291N-8-8	PF-1/2-14	-8	1.99	51	1-5/16	33	27	27
19291N-12-12	PF-3/4-14	-12	2.35	60	1-9/16	40	36	36

1B291N Female BSP Parallel Pipe Swivel - 90° Elbow (60° Cone)

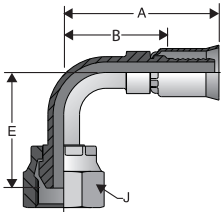

Construction: Steel nipple, tube, nut and shell. Add "C" for Stainless Steel.

Part Number	Thread Size	Hose Size inch	A		Cutoff Allow. B		E		J Hex mm
			inch	mm	inch	mm	inch	mm	
1B291N-8-8	PF-1/2-14	-8	2.04	52	1-3/8	35	1.57	40	27
1B291N-12-12	PF-3/4-14	-12	2.93	74	2-1/8	54	2.54	65	36

1GK91N Bulkhead with Integrated Zerk Port -Bulkhead Nut and Grease Zerk

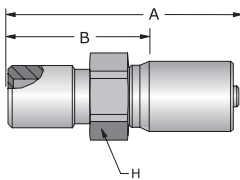

Construction: Steel nipple, tube, nut and shell. Add "C" for Stainless Steel.

Part Number	Thread Size	Hose Size inch	A		Cutoff Allow. B		H Hex inch
			inch	mm	inch	mm	
1GK91N-2-4*	1/8-27 NPSM Male with 1/4-28 UNF Female	-3	1.46	37	15/16	24	1/2

NOTE: *Long bulkhead for use with plates under 3/4" thick. Uses 2GK-NUT, sold separately.

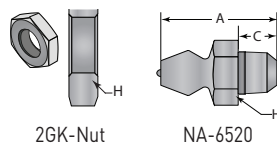

Construction: Steel.

Part Number	Description	Thread Size	A		C		H Hex inch
			inch	mm	inch	mm	
2GK-Nut	Bulkhead Nut	1/8-27 NPSM	0.188	4.8	na	na	11/16
NA-6520	Grease Zerk Fitting	1/4-28 UNF	0.540	13.7	0.18	4.6	5/16

WARNING This product can expose you to chemicals including Lead, which is known to the State of California to cause cancer and birth defects or other reproductive harm. For more information go to www.P65Warnings.ca.gov.

Fittings - Permanent Crimp

92 Series

92 Series	128	SAE Male Inverted Swivel Straight	167	SAE Male Inverted 45° Elbow	169	SAE Male Inverted 90° Elbow
Permanent		E-61		E-61		E-61

12892 SAE Male Inverted Swivel Straight

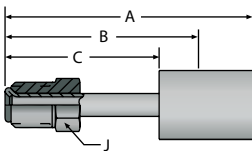

Construction: Stainless Steel.

Part Number	Thread Size	Hose Size	A		Cutoff Allow. B		C		J Hex
			inch	mm	inch	mm	inch	mm	inch
12892-3-3C	3/8-24	-3	2.01	55	1-1/2	38	1.25	32	7/16

16792 SAE Male Inverted Swivel 45° Elbow

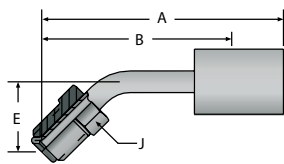

Construction: Stainless Steel.

Part Number	Thread Size	Hose Size	A		Cutoff Allow. B		E		J Hex
			inch	mm	inch	mm	inch	mm	inch
16792-3-3C	3/8-24	-3	2.36	60	1-15/16	50	.062	16	3/8

16992 SAE Male Inverted Swivel 90° Elbow

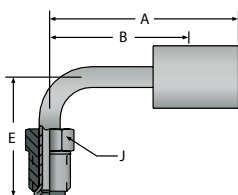

Construction: Stainless Steel.

Part Number	Thread Size	Hose Size	A		Cutoff Allow. B		E		J Hex
			inch	mm	inch	mm	inch	mm	inch
16992-3-3C	3/8-24	-3	1.45	37	1	25	1.25	16	3/8



WARNING

This product can expose you to chemicals including Lead, which is known to the State of California to cause cancer and birth defects or other reproductive harm. For more information go to www.P65Warnings.ca.gov.

Fittings - Permanent Crimp

93N Series

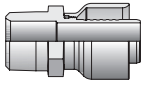
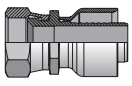
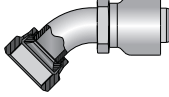
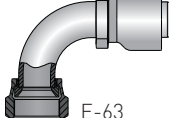
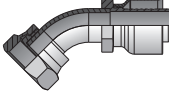
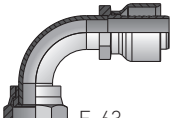
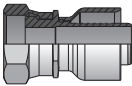
93N Series Permanent	101 Male Taper Pipe Rigid	106 Female JIC 37° Swivel	137 Female JIC 37° Swivel 45° Elbow	139 Female JIC 37° Swl. 90° Elbow Short	1J7 Seal-Lok™ 45° Elbow
	 E-62	 E-62	 E-62	 E-63	 E-63
	1J9 Seal-Lok™ 90° Elbow Short	1JC Seal-Lok™ Swivel Strt. Short			
	 E-63	 E-63			

10193N Male Taper Pipe Rigid

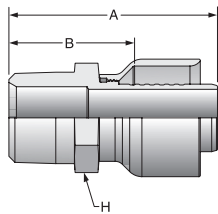

Construction: Steel.
Add "C" for Stainless Steel.

Part Number	Thread Size	Hose Size	A		Cutoff Allow. B		H Hex
			inch	mm	inch	mm	inch
10193N-8-8	1/2-14	-8	2.09	53	1-1/2	38	7/8
10193N-12-12	3/4-14	-12	2.70	69	1-5/8	41	1-1/8
10193N-16-16	1-11-1/2	-16	3.03	77	1-13/16	46	1-3/8
10193N-20-20	1-1/4-11-1/2	-20	3.20	58	1-7/8	48	1-11/16
10193N-24-24	1-1/2-11-1/2	-24	3.76	96	2-1/16	52	2
10193N-32-32	2-11-1/2	-32	3.97	101	2-5/16	59	2-1/2

10693N (JIC) 37° Female Swivel

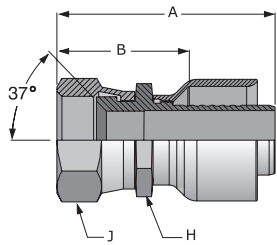

Construction: Steel.
Add "C" for Stainless Steel.

Part Number	Thread Size	Hose Size	A		Cutoff Allow. B		H Hex	J Hex
			inch	mm	inch	mm	inch	inch
10693N-6-6	9/16-18	-6	1.69	43	1-3/32	28	3/4	11/16
10693N-8-8	3/4-16	-8	2.02	51	1-3/8	35	7/8	7/8
10693N-10-10	7/8-14	-10	2.51	64	1-11/16	43	1	1
10693N-12-12	1-1/16-12	-12	2.86	73	1-3/4	44	1-1/8	1-1/4
10693N-16-16	1-5/16-12	-16	3.11	79	1-13/16	46	1-3/8	1-1/2
10693N-20-20	1-5/8-12	-20	3.28	83	2	51	1-3/4	2
10693N-24-24	1-7/8-12	-24	3.92	58	2-1/4	57	2	2-1/4
10693N-32-32	2-1/2-12	-32	4.12	105	2-7/16	62	2-1/2	2-7/8

NOTE: Size -10 incorporates a dual seat.

13793N JIC 37° Swivel 45° Elbow

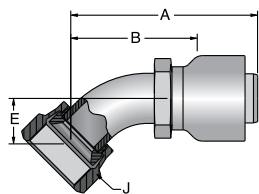

Construction: Steel.
Add "C" for Stainless Steel.

Part Number	Thread Size	Hose Size	A		Cutoff Allow. B		E		J Hex
			inch	mm	inch	mm	inch	mm	inch
13793N-12-12	1-1/16-12	-12	3.37	86	2-1/4	57	.78	20	1-1/4
13793N-16-16	1-5/16-12	-16	3.71	94	2-5/8	67	.90	23	1-1/2
13793N-20-20	1-5/8-12	-20	4.06	103	2-3/4	70	1.18	43	2
13793N-24-24	1-7/8-12	-24	5.76	146	4-1/4	108	1.47	37	2-1/4

NOTE: Size -10 incorporates a dual seat.

WARNING
This product can expose you to chemicals including Lead, which is known to the State of California to cause cancer and birth defects or other reproductive harm. For more information go to www.P65Warnings.ca.gov.

Fittings - Permanent Crimp

93N Series

13993N JIC 37° Swivel 90° Elbow Short Drop

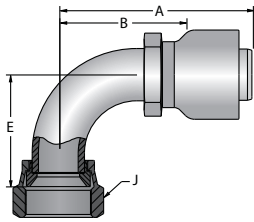

Construction: Steel.
Add "C" for Stainless Steel.

Part Number	Thread Size	Hose Size	A		Cutoff Allow. B		E		J Hex inch
			inch	mm	inch	mm	inch	mm	
13993N-8-8	3/4-16	-8	2.20	56	1-9/16	40	1.09	28	7/8
13993N-10-10	7/8-14	-10	2.41	61	1-11/16	43	1.23	31	1
13993N-12-12	1-1/16-12	-12	3.28	83	2-3/16	56	1.82	46	1-1/4
13993N-16-16	1-5/16-12	-16	3.71	94	2-1/2	64	2.14	54	1-1/2
13993N-20-20	1-5/8-12	-20	3.89	99	2-9/16	65	2.57	43	2
13993N-24-24	1-7/8-12	-24	5.72	58	4-1/4	108	3.17	81	2-1/4

NOTE: Size -10 incorporates a dual seat.

1JC93N Seal-Lok™ Swivel Straight Short

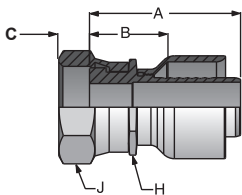

Construction: Steel.
Add "C" for Stainless Steel.

Part Number	Thread Size	Hose Size	A		Cutoff Allow. B		C		H Hex inch	J Hex inch
			inch	mm	inch	mm	inch	mm		
1JC93N-12-12	1-3/16-12	-12	2.30	58	1-3/8	35	.57	14	1-3/8	1-3/8
1JC93N-16-16	1-7/16-12	-16	2.61	66	1-3/8	35	.58	15	1-3/8	1-5/8
1JC93N-20-20	1-11/16-12	-20	2.65	67	1-5/16	33	.59	15	1-7/8	1-7/8

NOTE: When measuring overall length to the end of the nut, B+C dimensions must be used to calculate cut-off allowance

1J793N Seal-Lok™ 45° Elbow

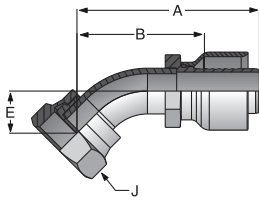

Construction: Steel.
Add "C" for Stainless Steel.

Part Number	Thread Size	Hose Size	A		Cutoff Allow. B		E		J Hex inch
			inch	mm	inch	mm	inch	mm	
1J793N-20-20	1-11/16-12	-20	4.25	108	2-15/16	75	1.00	25	1-7/8

1J993N Seal-Lok™ 90° Elbow Short Drop

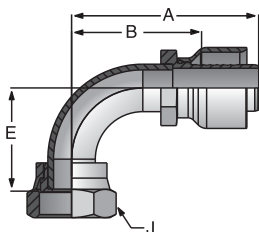

Construction: Steel.
Add "C" for Stainless Steel.

Part Number	Thread Size	Hose Size	A		Cutoff Allow. B		E		J Hex inch
			inch	mm	inch	mm	inch	mm	
1J993N-20-20	1-11/16-12	-20	4.36	111	3-1/16	78	2.51	64	1-7/8

WARNING
This product can expose you to chemicals including Lead, which is known to the State of California to cause cancer and birth defects or other reproductive harm. For more information go to www.P65Warnings.ca.gov.

Fittings - Permanent Crimp

94 Series, 95 Series

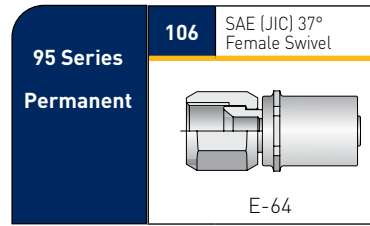
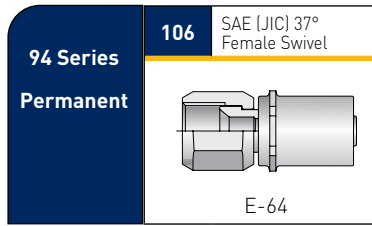

10694 SAE (JIC) 37° Female Swivel

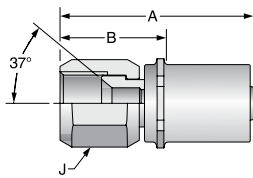

Construction: Steel.
Add "C" for Stainless Steel.

Part Number	Thread Size	Hose Size	A		Cutoff Allow. B		J Hex
			inch	mm	inch	mm	
10694-6-6	9/16-18	-8	2.09	53	1-3/16	30	7/8
10694-8-8	3/4-16	-10	2.30	58	1-5/16	33	1
10694-10-10	7/8-14	-10	2.38	60	1-5/16	33	1
10694-12-12	1-1/16-12	-12	2.45	62	1-5/16	33	1-1/4
10694-16-16	1-5/16-12	-16	2.72	69	1-7/16	37	1-1/2

10695 SAE (JIC) 37° Female Swivel

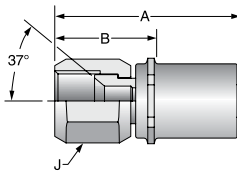

Construction: Steel.
Add "C" for Stainless Steel.

Part Number	Thread Size	Hose Size	A		Cutoff Allow. B		J Hex
			inch	mm	inch	mm	
10695-4-4	7/16-20	-6	1.76	45	15/16	24	9/16
10695-6-6	9/16-18	-8	2.09	53	1-3/16	30	11/16
10695-8-8	3/4-16	-10	2.30	58	1-5/16	33	7/8
10695-12-12	1-1/16-12	-12	2.45	62	1-5/16	33	1-1/4
10695-16-16	1-5/16-12	-16	2.72	69	1-7/16	37	1-1/2

WARNING
This product can expose you to chemicals including Lead, which is known to the State of California to cause cancer and birth defects or other reproductive harm. For more information go to www.P65Warnings.ca.gov.

Fittings - Permanent Crimp

PAGE Series

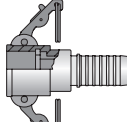
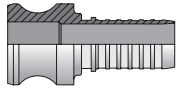
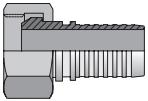
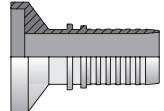
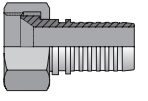
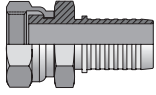
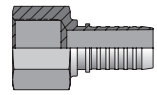
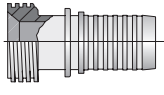
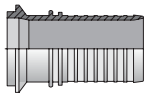
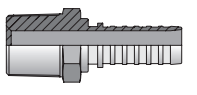
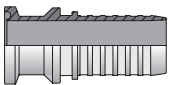
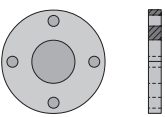
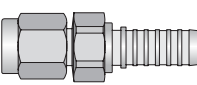
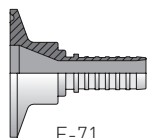
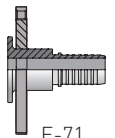
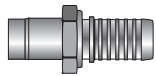
PAGE Series Permanent	CL Female Cam & Groove  E-66	E Male Cam & Groove  E-67	FBS Female Sanitary Bevel Seat  E-67	FIL Female I-Line® Sanitary  E-68	FJX Female JIC 37° Swivel  E-69
	FORFS Female Seat-Lok™ Swivel Short  E-69	FP Female NPTF Pipe Rigid  E-68	MBS Male Sanitary Bevel Seat  E-67	MIL Male I-Line® Sanitary  E-68	MP Male NPTF Pipe Rigid  E-69
	MSAN Mini Sanitary Flange  E-71	PF ANSI Flange  E-70	PLCF Female A-Lok® Compression  E-70	SAN Sanitary Flange & Step Downs  E-71	SFR Flange Retainer  E-71
	TUBE A-Lok Male Standpipe Rigid "V" Notch  E-70	PAGE fittings require a PAGE collar. See pg. E-66.			

The PAGE fitting call-out does not follow the traditional Parker fitting nomenclature. The end size and hose size are reversed.



WARNING

This product can expose you to chemicals including Lead, which is known to the State of California to cause cancer and birth defects or other reproductive harm. For more information go to www.P65Warnings.ca.gov.

Fittings - Permanent Crimp

PAGE Series

PAGE Fitting Collars - By Size



Hose Size	Collar # Size	04	06	08	12	14	16	20	24	32	40	48	64
STW STB	ST300	ST300	ST300	ST300	ST300	ST300	ST300	ST300	ST300				
SCW SCB	SC300	ST300	SC300	SC300	SC300	SC300	SC300	SC300	SC300	SC300			
SCWV SCBV	SC300			SC300	SC300	SC300	SC300	SC300	SC300	SC300	SC300	SC300	SC300
PCW PCB	PC300	PC300	PC300	PC300	PC300	PC300	PC300	PC300	PC300	PC300			

Construction: Stainless Steel. Also available in carbon steel "CS".

Inserts & Collars Sold Separately

Examples:

If you need a Female JIC Swivel Fitting for a 08-SCW Hose (1/2" Convuluted), place an order for (1) 08-08 FJX-S and (1) 08-SC300.

If you need a Male Pipe Fitting for a 12-STW Hose, place an order for (1) 12-12 MP-S and (1) 12-ST300.

PAGE Fitting Collars - By Style



Size	ST300 For use with STW, STB	SC300 For use with SCW, SCB, SCWV, SCBV	PC300 For use with PCW, PCB
1/4"	04-ST300	04-SC300	04-PC300
3/8"	06-ST300	06-SC300	06-PC300
1/2"	08-ST300	08-SC300	08-PC300
3/4"	12-ST300	12-SC300	12-PC300
1"	16-ST300	16-SC300	16-PC300
1-1/4"	20Z-ST300	20-SC300	20-PC300
1-1/2"	24Z-ST300	24-SC300	24-PC300
2"	—	32-SC300	32-PC300
3"	—	48-SC300	—
4"	—	64-SC300	—

Construction: Stainless Steel. Also available in carbon steel "CS".

The PAGE fitting call-out does not follow the traditional Parker fitting nomenclature. The end size and hose size are reversed.

CL Female Cam & Groove

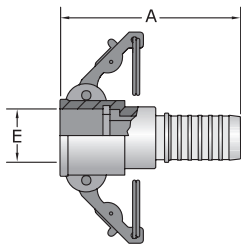

Part Number	Hose Size		A		E	
	inch	mm	inch	mm	inch	mm
16-16CL-S	1	25	4.2	107	1.44	37
24-24CL-S	1-1/2	38	5.2	132	2.10	53
32-32CL-S	2	51	6.0	152	2.48	63
48-48CL-S	3	76	7.2	183	3.60	91
64-64CL-S	4	102	7.8	198	4.70	119

Construction: Stainless Steel.

NOTE: Also available as encapsulated female cam under part number TEC and TECL.



WARNING

This product can expose you to chemicals including Lead, which is known to the State of California to cause cancer and birth defects or other reproductive harm. For more information go to www.P65Warnings.ca.gov.

Fittings - Permanent Crimp

PAGE Series

E Male Cam & Groove

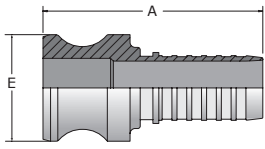

Construction: Stainless Steel.

Part Number	Hose Size		A		E	
	inch	mm	inch	mm	inch	mm
12-12E-S	3/4	19	2.60	66	1.26	32
16-16E-S	1	25	2.91	74	1.44	37
20-20E-S	1-1/4	32	3.64	93	1.78	45
24-24E-S	1-1/2	38	4.03	102	2.10	53
32-32E-S	2	51	4.75	121	2.48	63
48-48E-S	3	76	5.75	146	3.60	91
64-64E-S	4	102	5.88	149	4.70	119

NOTE: Also available as encapsulated female cam under part number TEC and TECL.

FBS Female Sanitary Bevel Seat

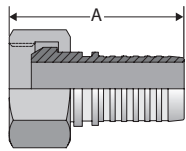

Construction: Stainless Steel.

Part Number	Acme Thread	Hose Size		A	
		inch	mm	inch	mm
16-16FBS-S	1-1/2-8	1	25	2.74	70
24-24FBS-S	2-8	1-1/2	38	3.41	87
32-32FBS-S	2-1/2-8	2	51	3.94	100
40-40FBS-S	3-8	2-1/2	64	4.37	110
48-48FBS-S	3-1/2-8	3	76	4.85	123
64-64FBS-S	4-5/8-6	4	102	5.24	133

NOTE: Also available as encapsulated female cam under part number TEC and TECL.

The PAGE fitting call-out does not follow the traditional Parker fitting nomenclature. The end size and hose size are reversed.

MBS Male Sanitary Bevel Seat

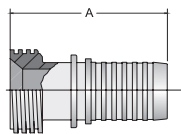

Construction: Stainless Steel.

Part Number	Acme Thread	Hose Size		A	
		inch	mm	inch	mm
16-16MBS-S	1-1/2-8	1	25	2.74	70
24-24MBS-S	2-8	1-1/2	38	3.41	87
32-32MBS-S	2-1/2-8	2	51	3.94	100
40-40MBS-S	3-8	2-1/2	64	4.37	110
48-48MBS-S	3-1/2-8	3	76	4.85	123
64-64MBS-S	4-5/8-6	4	102	5.24	133

NOTE: Also available as encapsulated female cam under part number TEC and TECL.



WARNING

This product can expose you to chemicals including Lead, which is known to the State of California to cause cancer and birth defects or other reproductive harm. For more information go to www.P65Warnings.ca.gov.

Fittings - Permanent Crimp

PAGE Series

FIL Female I-Line® Sanitary

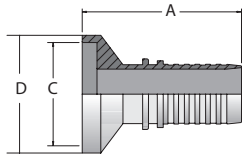

Construction: Stainless Steel.

Part Number	Hose Size		A		Flange Size C		D	
	inch	mm	inch	mm	inch	mm	inch	mm
16-16FIL-S	1	25	2.60	66	1.25	32	2.00	51
24-24FIL-S	1-1/2	38	3.43	87	1.76	45	2.00	51
32-32FIL-S	2	51	4.23	107	2.26	57	2.64	67
40-40FIL-S	2-1/2	25	2.60	66	1.25	32	2.00	51
48-48FIL-S	3	38	3.43	87	1.76	45	2.00	51

MIL Male I-Line® Sanitary

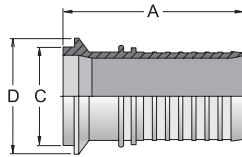

Construction: Stainless Steel.

Part Number	Hose Size		A		Flange Size C		D	
	inch	mm	inch	mm	inch	mm	inch	mm
16-16MIL-S	1	25	2.60	66	1.25	32	2.00	51
24-24MIL-S	1-1/2	38	3.43	87	1.76	45	2.00	51
32-32MIL-S	2	51	4.23	107	2.26	57	2.64	67
40-40MIL-S	2-1/2	64	4.42	112	2.76	70	3.31	84
48-48MIL-S	3	76	4.84	123	3.31	84	3.87	98

The PAGE fitting call-out does not follow the traditional Parker fitting nomenclature. The end size and hose size are reversed.

FP Female NPTF Pipe Rigid

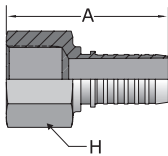

Construction: Stainless Steel.

Part Number	Thread Size	Hose Size		A		H Hex
		inch	mm	inch	mm	
04-04FP-S	1/4-18	1/4	6	1.63	41	3/4
06-06FP-S	3/8-18	3/8	10	1.73	44	7/8
08-08FP-S	1/2-14	1/2	13	2.25	57	1-1/16
12-12FP-S	3/4-14	3/4	19	2.60	66	1-5/16
16-16FP-S	1-11 1/2	1	25	2.85	72	1-5/8
20-20FP-S	1 1/4-11 1/2	1-1/4	32	3.50	89	2
24-24FP-S	1 1/2-11 1/2	1-1/2	38	3.63	92	2-3/8
32-32FP-S	2-11 1/2	2	51	4.25	108	2-7/8



WARNING

This product can expose you to chemicals including Lead, which is known to the State of California to cause cancer and birth defects or other reproductive harm. For more information go to www.P65Warnings.ca.gov.

Fittings - Permanent Crimp

PAGE Series

MP Male NPTF Pipe Rigid

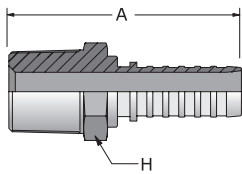

Construction: Stainless Steel.

Part Number	Thread Size	Hose Size		A		H Hex inch
		inch	mm	inch	mm	
04-04MP-S	1/4-18	1/4	6	1.63	41	9/16
06-06MP-S	3/8-18	3/8	10	1.76	45	11/16
08-08MP-S	1/2-14	1/2	13	2.34	59	7/8
12-12MP-S	3/4-14	3/4	19	2.59	66	1-1/8
16-16MP-S	1-11 1/2	1	25	3.00	76	1-3/8
20-20MP-S	1 1/4-11 1/2	1-1/4	32	3.39	86	1-3/4
24-24MP-S	1 1/2-11 1/2	1-1/2	38	3.89	99	2
32-32MP-S	2-11 1/2	2	51	4.58	116	2-1/2
40-40MP-S	2-1/2 8	2-1/2	64	5.28	134	3
48-48MP-S	3-8	3	76	5.93	151	3-3/4
64-64MP-S	4-8	4	102	6.82	173	4-5/8

The PAGE fitting call-out does not follow the traditional Parker fitting nomenclature. The end size and hose size are reversed.

FJX Female JIC 37° Swivel

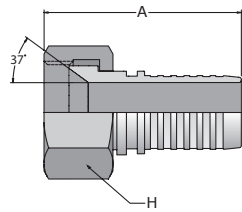

Construction: Stainless Steel.

Part Number	Thread Size	Hose Size		A		H Hex inch
		inch	mm	inch	mm	
04-04FJX-S	7/16-20	1/4	6	1.44	37	9/16
06-06FJX-S	9/16-18	3/8	10	1.65	42	11/16
08-08FJX-S	3/4-16	1/2	13	2.13	54	7/8
12-12FJX-S	1-1/16-12	3/4	19	2.54	65	1-1/4
16-16FJX-S	1-5/16-12	1	25	2.76	70	1-1/2
20-20FJX-S	1-5/8-12	1-1/4	32	3.25	83	2
24-24FJX-S	1-7/8-12	1-1/2	38	3.73	95	2-1/4
32-32FJX-S	2-1/2-12	2	51	4.55	116	2-7/8
40-40FJX-S	3-12	2-1/2	64	4.76	121	3-3/8

FORFS Female Seal-Lok® Swivel Short

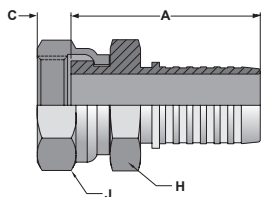

Construction: Stainless Steel.

Part Number	Thread Size	Hose Size		A		C		H Hex inch	J Hex inch
		inch	mm	inch	mm	inch	mm		
04-04FORFS-S	9/16-18	1/4	6	1.50	38	.32	8	9/16	11/16
06-06FORFS-S	11/16-16	3/8	10	1.85	47	.32	8	11/16	13/16
08-08FORFS-S	13/16-16	1/2	13	2.00	51	.43	11	13/16	15/16
12-12FORFS-S	1-3/16-12	3/4	19	2.30	58	.57	14	1-1/8	1-3/8
16-16FORFS-S	1-7/16-12	1	25	2.50	64	.58	15	1-3/8	1-5/8
24-24FORFS-S	2-12	1-1/2	38	3.98	101	.59	15	2	2-1/4



WARNING

This product can expose you to chemicals including Lead, which is known to the State of California to cause cancer and birth defects or other reproductive harm. For more information go to www.P65Warnings.ca.gov.

Fittings - Permanent Crimp

PAGE Series

A Hose

B Tubing Thermoplastic

C Coiled Air Hose & Fittings

D Transportation

M Fittings

F Tooling, Equipment & Accessories

G General Technical

PLCF Female A-LOK® Compression (With Nut & Ferrules)

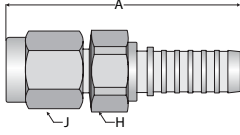

Construction: Stainless Steel.

Part Number	Thread Size	Hose Size		A		J Hex	H Hex
		inch	mm	inch	mm	inch	inch
04-04PLCF-S	7/16-20	1/4	6	1.52	39	9/16	9/16
06-06PLCF-S	9/16-20	3/8	10	1.63	41	11/16	11/16
08-08PLCF-S	3/4-20	1/2	13	2.05	52	7/8	7/8
12-12PLCF-S	1-20	3/4	19	2.30	58	1-1/8	1-1/8
16-16PLCF-S	1-5/16-20	1	25	2.57	65	1-3/8	1-1/2

TUBE A-LOK® Male Standpipe Rigid with "V" Notch

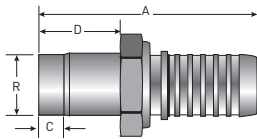

Construction: Stainless Steel.

Part Number	Diameter R	Hose Size		A		C		D		H Hex
		inch	mm	inch	mm	inch	mm	inch	mm	inch
04-04TUBE-S	1/4	1/4	6	1.75	45	.18	5	.66	17	7/16
06-06TUBE-S	3/8	3/8	10	2.06	52	.25	6	.85	2	5/8
08-08TUBE-S	1/2	1/2	13	2.56	65	.34	9	.97	25	3/4
12-12TUBE-S	3/4	3/4	19	2.86	73	.40	10	1.02	26	1-1/8
16-16TUBE-S	1	1	25	3.34	85	.52	13	1.30	33	1-3/8
20-20TUBE-S	1-1/4	1-1/4	32	4.05	10	.50	13	1.75	45	1-3/4

The PAGE fitting call-out does not follow the traditional Parker fitting nomenclature. The end size and hose size are reversed.

PF ANSI B16.5 Flange

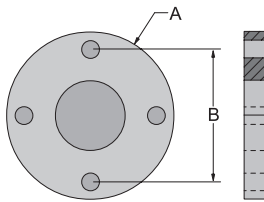

Construction: 316 Stainless Steel.

Part Number	Flange Diameter A		Hose Size		Bolt Spacing B	
	inch	mm	inch	mm	inch	mm
08-PF156	3-1/2	89	1/2	13	2-3/8	60
12-PF156	3-7/8	98	3/4	19	2-3/4	70
16-PF156	4-1/4	108	1	25	3-1/8	79
20-PF156	4-5/8	117	1-1/4	32	3-1/2	89
24-PF156	5	127	1-1/2	38	3-7/8	98
32-PF156	6	152	2	51	4-3/4	120
40-PF156	7	178	2-1/2	64	5-1/2	140
48-PF156	7-1/2	191	3	76	6	152
64-PF156	9	229	4	102	7-1/2	191

WARNING This product can expose you to chemicals including Lead, which is known to the State of California to cause cancer and birth defects or other reproductive harm. For more information go to www.P65Warnings.ca.gov.

Fittings - Permanent Crimp

PAGE Series

SFR Flange Retainer

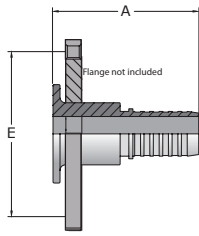

Construction: Stainless Steel.

Part Number	Flange Diameter		Hose Size		A		Bolt Spacing E	
	inch	mm	inch	mm	inch	mm	inch	mm
08-08SFR-S	3-1/2	89	1/2	13	2.30	58	2-3/8	60
12-12SFR-S	3-7/8	98	3/4	19	2.60	66	2-3/4	70
16-16SFR-S	4-1/4	108	1	25	3.00	76	3-1/8	79
20-20SFR-S	4-5/8	117	1-1/4	32	3.25	83	3-1/2	89
24-24SFR-S	5	127	1-1/2	38	3.65	93	3-7/8	98
32-32SFR-S	6	152	2	51	4.25	108	4-3/4	120
40-40SFR-S	7	178	2-1/2	64	5.00	127	5-1/2	140
48-48SFR-S	7-1/2	191	3	76	5.50	140	6	152
64-64SFR-S	9	229	4	102	7.00	178	7-1/2	191

MSAN Mini Sanitary Flange

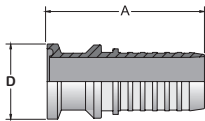

Construction: Stainless Steel.

Part Number	Hose Size		A		Flange Size D	
	inch	mm	inch	mm	inch	mm
04-04MSAN-S	1/4	6	1.41	36	.98	25
04-08MSAN-S	1/4	6	1.50	38	.98	25
06-06MSAN-S	3/8	10	1.53	39	.98	25
06-08MSAN-S	3/8	10	1.53	39	.98	25
06-12MSAN-S	3/8	10	1.66	42	.98	25
08-08MSAN-S	1/2	13	1.90	48	.98	25
08-12MSAN-S	1/2	13	1.94	49	.98	25
12-12MSAN-S	3/4	19	2.16	55	.98	25
16-16MSAN-S	1	25	2.27	58	1.34	34

SAN Sanitary Flange & Step-Downs

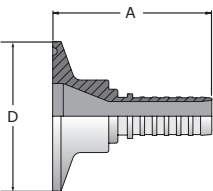

Construction: Stainless Steel.

Part Number	Hose Size		A		Flange Size D	
	inch	mm	inch	mm	inch	mm
08-08SAN-S	1/2	13	2.11	54	1.98	50
08-16SAN-S	1/2	13	2.11	54	1.98	50
08-24SAN-S	1/2	13	2.34	59	1.98	50
12-12SAN-S	3/4	19	2.32	59	1.98	50
16-16SAN-S	1	25	2.45	62	1.98	50
12-24SAN-S	3/4	19	2.34	59	1.98	50
16-24SAN-S	1	25	2.32	59	1.98	50
24-24SAN-S	1-1/2	38	3.1	79	1.98	50
24-32SAN-S	1-1/2	38	3.12	79	2.52	64
32-32SAN-S	2	51	3.67	93	2.52	64
40-40SAN-S	2-1/2	64	4	102	3.05	77
48-48SAN-S	3	76	4.5	114	3.58	91
64-64SAN-S	4	102	4.75	121	4.68	119

The PAGE fitting call-out does not follow the traditional Parker fitting nomenclature.

The end size and hose size are reversed.



WARNING

This product can expose you to chemicals including Lead, which is known to the State of California to cause cancer and birth defects or other reproductive harm. For more information go to www.P65Warnings.ca.gov.

Fittings - Permanent Crimp

CG Series

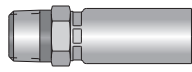
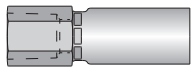
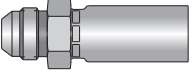
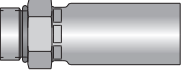
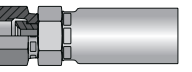
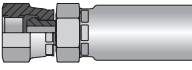
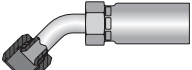
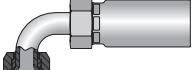
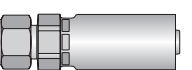
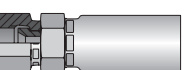
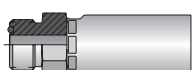
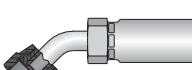
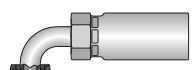
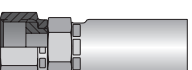
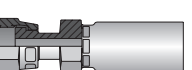
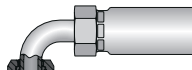
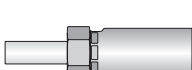
CG Series Permanent	101 Male Taper Pipe Rigid	102 Female Taper Pipe Rigid	103 Male (JIC) 37° Rigid	105 Male Str. Thread O-ring	106 SAE (JIC) 37° Swivel
					
	E-72	E-73	E-73	E-73	E-73
	107 Female Pipe Swivel	137 Female JIC 37° Swivel 45° Elbow	139 FM JIC 37° Swivel 90° Elbow Short	1AL A-Lok® Compression	1FU (JIS)/BSP 30° Flare Female Swivel
					
E-74	E-74	E-74	E-74	E-75	
1J0 Male Seal-Lok™ Rigid Str. w/O-ring	1J7 Female Seal-Lok™ 45° Elbow	1J9 Female Seal-Lok™ 90° Elbow Short	1JC Female Seal-Lok™ Str. Swivel Short	1JS Female Seal-Lok™ Straight	
					
E-75	E-75	E-75	E-76	E-76	
1L9 FM JIC 37° Swivel 90° Elbow, SPL Drop	1TU Universal Tube Stub End				
					
E-76	E-76				

101CG Male Taper Pipe Rigid

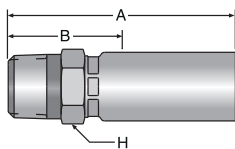

Construction: Steel. Add "C" for Stainless Steel.

Part Number	Thread Size	Hose I.D.		A		Cutoff Allow. B		H Hex inch
		inch	mm	inch	mm	inch	mm	
101CG-2-3	1/8-27	3/16	5	1.94	49	1	25	9/16
101CG-2-4	1/8-27	1/4	6	2.13	54	1	25	5/8
101CG-4-3	1/4-18	3/16	5	2.12	54	1-3/16	30	11/16
101CG-4-4	1/4-18	1/4	6	2.31	59	1-3/16	30	11/16
101CG-4-6	1/4-18	3/8	10	2.66	68	1-5/16	33	3/4
101CG-6-4	3/8-18	1/4	6	2.41	61	1-5/16	33	3/4
101CG-6-6	3/8-18	3/8	10	2.66	68	1-5/16	33	3/4
101CG-6-8	3/8-18	1/2	13	2.85	72	1-5/16	33	7/8
101CG-8-6	1/2-14	3/8	10	2.91	74	1-9/16	40	15/16
101CG-8-8	1/2-14	1/2	13	3.09	78	1-9/16	40	15/16
101CG-12-12	3/4-14	3/4	19	3.91	99	1-11/16	43	1-1/4
101CG-16-16	1-11-1/2	1	25	4.76	121	2	51	1-3/4



WARNING

This product can expose you to chemicals including Lead, which is known to the State of California to cause cancer and birth defects or other reproductive harm. For more information go to www.P65Warnings.ca.gov.

Fittings - Permanent Crimp

CG Series

102CG Female Taper Pipe Rigid

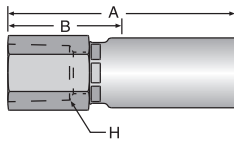

Construction: Steel. Add "C" for Stainless Steel.

Part Number	Thread Size	Hose I.D.		A		Cutoff Allow. B		H Hex
		inch	mm	inch	mm	inch	mm	inch
102CG-4-4	1/4-18	1/4	6	2.39	61	1-1/4	32	3/4
102CG-6-4	3/8-18	1/4	6	2.60	66	1-1/2	38	7/8
102CG-8-8	1/2-14	1/2	13	2.87	73	1-3/8	35	1-1/16

103CG Male (JIC) 37° Rigid

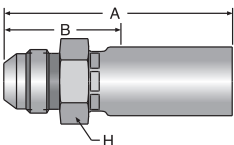

Construction: Steel. Add "C" for Stainless Steel.

Part Number	Diameter R	Hose Size		A		C		H Hex
		inch	mm	inch	mm	inch	mm	inch
103CG-4-4	7/16-20	1/4	6	2.31	58	1-3/16	30	5/8
103CG-5-4	1/2-20	1/4	6	2.30	58	1-3/16	30	5/8
103CG-6-4	9/16-18	1/4	6	2.30	58	1-3/16	30	11/16
103CG-6-6	9/16-18	3/8	10	2.65	67	1-1/4	32	3/4

105CG Male Straight Thread O-ring (Nitrile O-ring included)

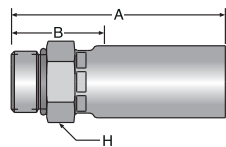

Construction: Steel. Add "C" for Stainless Steel.

Part Number	Diameter R	Hose Size		A		C		H Hex
		inch	mm	inch	mm	inch	mm	inch
105CG-4-3	7/16-20	3/16	4	1.98	50	1-1/8	29	9/16
105CG-4-4	7/16-20	1/4	6	2.11	54	1	25	5/8
105CG-6-4	9/16-18	1/4	6	2.14	54	1	25	11/16
105CG-6-6	9/16-18	3/8	10	2.42	61	1-1/8	29	3/4
105CG-8-8	3/4-16	1/2	13	2.65	67	1-3/16	30	7/8
105CG-10-8	7/8-14	1/2	13	2.77	70	1-5/16	33	1

NOTE: Nitrile O-ring.

106CG SAE (JIC) 37° Swivel

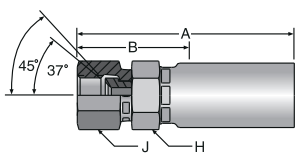

Construction: Steel. Add "C" for Stainless Steel.

Part Number	Thread Size	Hose I.D.		A		Cutoff Allow. B		H Hex	J Hex
		inch	mm	inch	mm	inch	mm	inch	inch
106CG-3-3	3/8-24	3/16	5	2.23	57	1-5/16	33	9/16	9/16
106CG-4-3	7/16-20	3/16	5	2.23	57	1-1/4	32	9/16	9/16
106CG-4-4	7/16-20	1/4	6	2.36	60	1-3/16	30	5/8	9/16
106CG-5-4	1/2-20	1/4	6	2.43	62	1-1/4	32	5/8	5/8
106CG-6-4	9/16-18	1/4	6	2.45	62	1-5/16	33	5/8	11/16
106CG-6-6	9/16-18	3/8	10	2.70	69	1-5/16	33	11/16	11/16
106CG-8-6	3/4-16	3/8	10	2.89	73	1-1/2	38	11/16	7/8
106CG-8-8	3/4-16	1/2	13	3.08	78	1-1/2	38	7/8	7/8
106CG-10-8	7/8-14	1/2	13	3.12	79	1-5/8	41	7/8	1-1/16
106CG-12-8	1-1/16-12	1/2	13	3.35	85	1-13/16	46	1	1-1/4
106CG-12-12	1-1/16-12	3/4	19	4.17	106	1-13/16	46	1-1/4	1-5/16
106CG-16-12	1-5/16-12	3/4	19	4.27	108	2	51	1-1/2	1-5/8
106CG-16-16	1-5/16-12	1	25	4.93	125	2-3/16	56	1-3/4	1-5/8

NOTE: Sizes -4, -5, -8 and -10 incorporate a dual seat.



WARNING

This product can expose you to chemicals including Lead, which is known to the State of California to cause cancer and birth defects or other reproductive harm. For more information go to www.P65Warnings.ca.gov.

Fittings - Permanent Crimp

CG Series

107CG Female Pipe Swivel

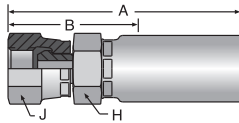

Part Number	Thread Size	Hose I.D.		A		Cutoff Allow. B		H Hex inch	J Hex inch
		inch	mm	inch	mm	inch	mm		
107CG-6-6	3/8-18	3/8	10	2.61	66	1-3/16	30	11/16	7/8

Construction: Steel. Add "C" for Stainless Steel.

137CG Female JIC 37° Swivel 45° Elbow

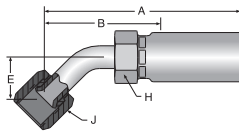

Part Number	Thread Size	Hose I.D.		A		Cutoff Allow. B		E		H Hex inch	J Hex inch
		inch	mm	inch	mm	inch	mm	inch	mm		
137CG-4-4	7/16-20	1/4	6	2.49	63	1-1/2	38	0.33	8	5/8	9/16
137CG-6-6	9/16-18	3/8	10	2.91	74	1-9/16	40	0.39	10	3/4	11/16
137CG-8-8	3/4-16	1/2	13	3.37	86	1-13/16	46	0.55	14	7/8	7/8

Construction: Steel. Add "C" for Stainless Steel.

139CG Female JIC 37° Swivel 90° Elbow

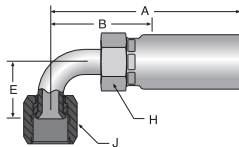

Part Number	Thread Size	Hose I.D.		A		Cutoff Allow. B		E		H Hex inch	J Hex inch
		inch	mm	inch	mm	inch	mm	inch	mm		
139CG-4-4	7/16-20	1/4	6	2.49	63	1-3/8	35	0.68	17	5/8	9/16
139CG-6-4	9/16-18	1/4	6	2.57	65	1-9/16	36	0.85	22	5/8	11/16
139CG-6-6	9/16-18	3/8	10	2.88	73	1-1/2	38	0.91	23	3/4	11/16
139CG-8-6	3/4-16	3/8	10	2.92	74	1-9/16	40	1.09	28	3/4	7/8
139CG-8-8	3/4-16	1/2	13	3.11	79	1-5/8	41	1.09	28	7/8	7/8
139CG-12-12	1-1/16-12	3/4	19	4.55	116	2-1/4	57	1.82	46	1-1/4	1-1/4

Construction: Steel. Add "C" for Stainless Steel.

1ALCG A-LOK® Compression

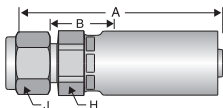

Part Number	Hose Size	A		Cutoff Allow. B		H Hex inch	J Hex inch
		inch	mm	inch	mm		
1ALCG-6-6C	-6	1.46	37	7/16	11	3/4	11/16

Construction: Stainless steel.

NOTE: Nuts and Ferrules are Manufactured by the Instrumentation Products Division. Refer to Catalog 4230/4233 for information.

Nut part No. is XNUX-316

Front ferrule part No. is XFFX-316

Back ferrule part No. is XBFX-316

X denotes dash size.



WARNING

This product can expose you to chemicals including Lead, which is known to the State of California to cause cancer and birth defects or other reproductive harm. For more information go to www.P65Warnings.ca.gov.

Fittings - Permanent Crimp

CG Series

1FUCG (JIS)/BSP 30° Flare Female Swivel ISO 228-1

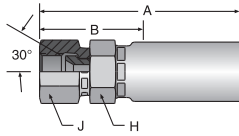

Construction: Steel. Add "C" for Stainless Steel.

Part Number	Thread Size	Hose I.D.		A		Cutoff Allow. B		H Hex	J Hex
		inch	mm	inch	mm	inch	mm	mm	mm
1FUCG-4-4	PF 1/4-19	1/4	6	2.48	63	1-9/16	40	19	19

1J0CG Male Seal-Lok™ Rigid Straight (with Nitrile O-ring) ISO 12151-1-S

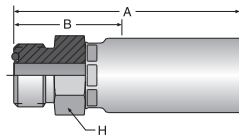

Construction: Steel. Add "C" for Stainless Steel.

Part Number	Thread Size	Hose I.D.		A		Cutoff Allow. B		H Hex
		inch	mm	inch	mm	inch	mm	inch
1J0CG-4-4	9/16-18	1/4	6	2.20	56	1-1/16	27	5/8

NOTE: Nitrile O-ring.

1J7CG Female Seal-Lok™ Swivel 45° Elbow ISO 12151-1-SWE45

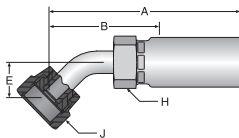

Construction: Steel. Add "C" for Stainless Steel.

Part Number	Thread Size	Hose I.D.		A		Cutoff Allow. B		E		H Hex	J Hex
		inch	mm	inch	mm	inch	mm	inch	mm	inch	inch
1J7CG-4-4	9/16-18	1/4	6	2.66	68	1-1/2	38	0.41	10	5/8	11/16
1J7CG-8-8	13/16-16	1/2	13	3.43	87	1-15/16	49	0.59	15	7/8	15/16
1J7CG-12-12	1-3/16-12	3/4	19	4.51	115	2-3/16	56	0.81	21	1-1/4	1-3/8

1J9CG Female Seal-Lok™ Swivel 90° Elbow ISO 12151-1-SWE90

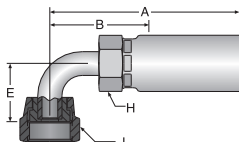

Construction: Steel. Add "C" for Stainless Steel.

Part Number	Thread Size	Hose I.D.		A		Cutoff Allow. B		E		H Hex	J Hex
		inch	mm	inch	mm	inch	mm	inch	mm	inch	inch
1J9CG-4-4	9/16-18	1/4	6	2.49	63	1-3/8	35	0.82	21	5/8	11/16
1J9CG-6-6	11/16-16	3/8	10	2.85	72	1-1/2	38	0.91	23	3/4	13/16
1J9CG-12-12	1-3/16-12	3/4	19	4.42	112	2-1/8	54	1.89	48	1-1/4	1-3/8
1J9CG-16-16	1-7/16-12	1	25	5.78	147	3	76	2.28	58	1-3/4	1-5/8



WARNING

This product can expose you to chemicals including Lead, which is known to the State of California to cause cancer and birth defects or other reproductive harm. For more information go to www.P65Warnings.ca.gov.

Fittings - Permanent Crimp

CG Series

1JCCG Female Seal-Lok™ Straight Swivel Short ISO 12151-1-SWSA

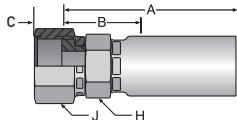

Construction: Steel. Add "C" for Stainless Steel.

Part Number	Thread Size	Hose I.D.		A		Cutoff Allow. B		C		H Hex	J Hex
		inch	mm	inch	mm	inch	mm	inch	mm	inch	inch
1JCCG-4-3	9/16-18	3/16	5	1.88	48	15/16	24	.34	9	9/16	11/16
1JCCG-4-4	9/16-18	1/4	6	2.16	55	1-1/16	25	.34	9	5/8	11/16
1JCCG-6-4	11/16-16	1/4	6	2.22	56	1-1/16	27	.32	8	11/16	13/16
1JCCG-6-6	11/16-16	3/8	10	2.47	63	1-1/16	27	.32	8	11/16	13/16
1JCCG-8-6	13/16-16	3/8	10	2.56	65	1-3/16	30	.43	11	7/8	15/16
1JCCG-8-8	13/16-16	1/2	13	2.75	70	1-3/16	30	.43	11	7/8	15/16
1JCCG-10-8	1-14	1/2	13	2.95	75	1-3/8	35	.48	12	1-1/8	1-1/8
1JCCG-12-12	1-3/16-12	3/4	19	3.86	98	1-1/2	38	.55	14	1-1/4	1-3/8
1JCCG-16-16	1-7/16-12	1	25	4.66	118	1-7/8	48	.56	14	1-3/4	1-5/8

NOTE: When measuring overall length to the end of the nut, B+C dimensions must be used to calculate cut-off allowance

1JSCG Female Seal-Lok™ Straight

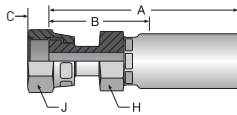

Construction: Steel. Add "C" for Stainless Steel.

Part Number	Thread Size	Hose I.D.		A		Cutoff Allow. B		H Hex	C	J Hex	
		inch	mm	inch	mm	inch	mm	inch	inch	inch	
1JSCG-4-4	9/16-18	1/4	6	2.42	61	1-1/4	32	5/8	.32	8	11/16
1JSCG-6-6	11/16-16	3/8	10	2.73	69	1-5/16	33	11/16	.34	9	13/16
1JSCG-8-6	13/16-16	3/8	10	3.00	76	1-5/8	41	7/8	.43	11	15/16
1JSCG-12-12	1-3/16-12	3/4	19	4.29	109	2	51	1-1/4	.55	14	1-3/8
1JSCG-16-16	1-7/16-12	1	25	4.99	127	2-3/16	56	1-3/4	.56	14	1-5/8

NOTE: When measuring overall length to the end of the nut, B+C dimensions must be used to calculate cut-off allowance

1L9CG Female JIC 37° Swivel 90° Elbow Special Drop

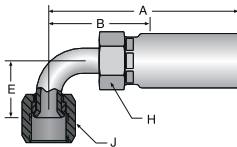

Construction: Steel. Add "C" for Stainless Steel.

Part Number	Thread Size	Hose I.D.		A		Cutoff Allow. B		E		H Hex	J Hex
		inch	mm	inch	mm	inch	mm	inch	mm	inch	inch
1L9CG-4-4	7/16-20	1/4	6	2.47	63	1-3/8	35	0.88	22	5/8	9/16
1L9CG-6-6	9/16-18	3/8	10	2.88	73	1-7/16	36	1.12	28	3/4	11/16

1TUCG Universal Tube Stub

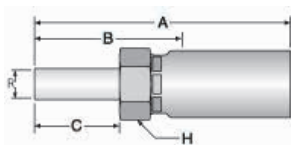

Construction: Stainless Steel.

Part Number	Diameter R	Hose I.D.		A		Cutoff Allow. B		C		H Hex
		inch	mm	inch	mm	inch	mm	inch	mm	inch
1TUCG-4-4C	1/4	1/4	6	2.60	66	1-1/2	38	0.72	38	0.72
1TUCG-6-6C	3/8	3/8	10	2.91	74	1-1/2	38	0.78	38	0.78
1TUCG-8-8C	1/2	1/2	13	3.35	85	1-13/16	46	1.03	46	1.03
1TUCG-12-12C	3/4	3/4	19	4.18	106	1-7/8	48	1.03	48	1.03
1TUCG-16-16C	1	1	25	5.14	131	2-3/8	60	1.36	60	1.36

NOTE: Use with A-Lok & CPI nuts, sleeves and adapters. These components are manufactured by Parker's Instrumentation Connectors Division. Refer to catalog 4230/4233 for information.







WARNING

This product can expose you to chemicals including Lead, which is known to the State of California to cause cancer and birth defects or other reproductive harm. For more information go to www.P65Warnings.ca.gov.

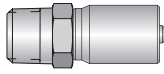
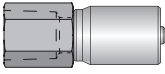
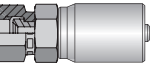
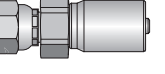
Fittings - Permanent Crimp

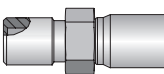
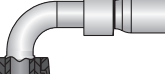
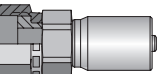
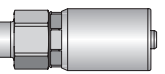
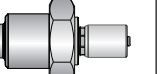
CY Series

CY Series Permanent	101	102	106	113	139
	Male Taper Pipe Rigid	Female Pipe Thread	Female SAE JIC 37° Swivel	Male Pipe Swivel	FM JIC 37° Swivel 90° Elbow Short
					
E-77	E-77	E-78	E-78	E-78	
1GK	1J9	1JC	1LM	1PD	
Bulkhead w/Zerk Port Integrated	Female Seal-Lok™ 90° Elbow Short	Female Seal-Lok™ Swivel Strt. Short	Male Grease	Integrated Bulkhead Diagnostic Nipple	
					
E-79	E-79	E-78	E-79	E-79	

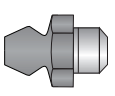
1GKCY Options	Nut	Zerk
	2GK-Nut	NA-6520
		
E-79	E-79	

101CY Male Taper Pipe Rigid

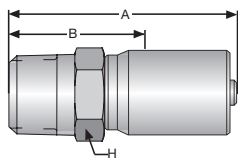

Construction: Steel. Add "C" for Stainless Steel.

Part Number	Thread Size	Hose I.D.		A		Cutoff Allow. B		H Hex inch
		inch	mm	inch	mm	inch	mm	
101CY-2-2	1/8-27	1/8	3	1.31	33	13/16	21	7/16
101CY-2-3	1/8-27	3/16	5	1.74	44	7/8	22	1/2
101CY-4-2	1/4-18	1/8	3	1.51	38	1	25	9/16
101CY-4-3	1/4-18	3/16	5	1.97	50	1-1/8	28	9/16

102CY Female Pipe Thread

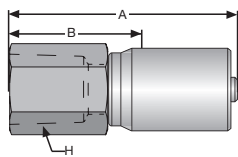

Construction: Steel. Add "C" for Stainless Steel.

Part Number	Thread Size	Hose I.D.		A		Cutoff Allow. B		H Hex inch
		inch	mm	inch	mm	inch	mm	
102CY-2-3	1/8-27	3/16	5	1.97	50	1-1/16	27	1/2



WARNING

This product can expose you to chemicals including Lead, which is known to the State of California to cause cancer and birth defects or other reproductive harm. For more information go to www.P65Warnings.ca.gov.

Fittings - Permanent Crimp

CY Series

106CY Female SAE (JIC) 37° Swivel

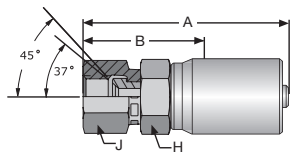

Construction: Steel. Add "C" for Stainless Steel.

Part Number	Thread Size	Hose I.D.		A		Cutoff Allow. B		H Hex inch	J Hex inch
		inch	mm	inch	mm	inch	mm		
106CY-2-2	5/16-24	1/8	3	1.52	39	15/16	24	7/16	7/16
106CY-3-2	3/8-24	1/8	3	1.53	39	1	25	1/2	1/2
106CY-4-2	7/16-20	1/8	3	1.59	40	1	25	9/16	9/16
106CY-4-3	7/16-20	3/16	5	1.99	50	1-1/8	29	9/16	9/16

NOTE: Size -4 incorporates a dual seat.

113CY Male Pipe Swivel*

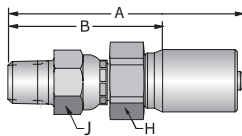

Construction: Steel. Add "C" for Stainless Steel.

Part Number	Thread Size	Hose I.D.		A		Cutoff Allow. B		H Hex inch	J Hex inch
		inch	mm	inch	mm	inch	mm		
113CY-2-2	1/8-27	1/8	3	1.89	48	1-5/16	33	1/2	1/2
113CY-2-3	1/8-27	3/16	3	2.29	58	1-7/16	36	1/2	1/2

NOTE: *Nitrile O-ring.

WARNING: Fittings allow minor movement to relieve stress on hose but are not recommended for continuous or extensive swiveling.

139CY Female JIC 37° Swivel 90° Elbow Short Drop

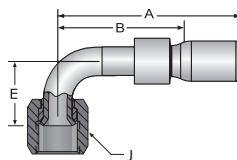

Construction: Steel. Add "C" for Stainless Steel.

Part Number	Thread Size	Hose I.D.		A		Cutoff Allow. B		E		J Hex inch
		inch	mm	inch	mm	inch	mm	inch	mm	
139CY-4-2	7/16-20	1/8	3	1.61	41	1-1/8	29	0.83	21	9/16
139CY-4-3	7/16-20	3/16	5	1.90	48	1	25	0.83	21	9/16

1JCCY Female Seal-Lok™ Swivel Straight Short

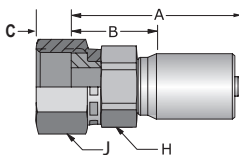

Construction: Steel. Add "C" for Stainless Steel.

Part Number	Thread Size	Hose I.D.		A		Cutoff Allow. B		C		H Hex inch	J Hex inch
		inch	mm	inch	mm	inch	mm	inch	mm		
1JCCY-4-2	9/16-18	1/8	3	1.29	33	3/4	19	0.32	8	9/16	11/16

NOTE: When measuring overall length to the end of the nut, B+C dimensions must be used to calculate cut-off allowance.



WARNING

This product can expose you to chemicals including Lead, which is known to the State of California to cause cancer and birth defects or other reproductive harm. For more information go to www.P65Warnings.ca.gov.

Fittings - Permanent Crimp

CY Series

A Hose

1GKCY Bulkhead with Integrated Zerk Port Bulkhead Nut and Grease Zerk

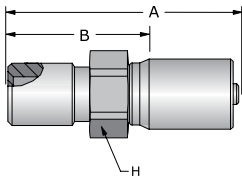

Construction: Steel. Add "C" for Stainless Steel.

Part Number	Thread Size	Hose I.D.		A		Cutoff Allow. B		H Hex inch
		inch	mm	inch	mm	inch	mm	
1GKCY-2-2*	1/8-27 NPSM Male with 1/4-28 UNF Female	1/8	3	1.45	37	7/8	22	1/2
1GKCY-2-3*	1/8-27 NPSM Male with 1/4-28 UNF Female	3/16	5	1.86	47	1	25	1/2
1GKCY-2-L77**	1/8-27 NPSM Male with 1/4-28 UNF Female	1/8	3	1.71	43	1-1/4	32	1/2

NOTE: *Standard bulkhead for use with plates up to 1/4" thick. Uses 2GK-NUT, sold separately.
**Long bulkhead for use with plates under 3/4" thick. Uses 2GK-NUT, sold separately.

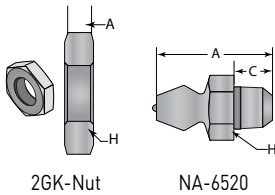

Construction: Steel.

Part Number	Description	Thread Size	A		C		H Hex inch
			inch	mm	inch	mm	
2GK-Nut	Bulk-head Nut	1/8-27 NPSM	0.188	4.8	na	na	11/16
NA-6520	Grease Zerk Fit-ting	1/4-28 UNF	0.540	13.7	0.18	4.6	5/16
CY02-652317	HLBD02 Spring Guard	-	-	-	-	-	-
3PSG-4	HLB03 Spring Guard	-	-	-	-	-	-

B Tubing

C Coiled Air Hose & Fittings

1J9CY Female Seal-Lok™ 90° Elbow Short Drop

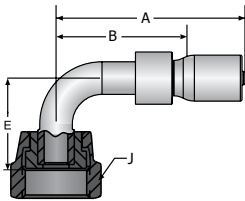

Construction: Steel. Add "C" for Stainless Steel.

Part Number	Thread Size	Hose I.D.		A		Cutoff Allow. B		E		J Hex inch
		inch	mm	inch	mm	inch	mm	inch	mm	
1J9CY-4-2	9/16-18	1/8	3	1.81	46	1-1/4	32	.83	21	11/16

D Transportation

1LMCY Male Grease

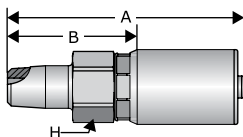

Construction: Steel. Add "C" for Stainless Steel.

Part Number	Thread Size	Hose I.D.		A		Cutoff Allow. B		H Hex inch
		inch	mm	inch	mm	inch	mm	
1LMCY-2-2	1/4-28	1/8	3	1.26	32	11/16	17	3/8

E Fittings

1PCY Integrated Bulkhead Diagnostic Nipple

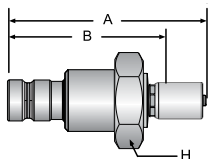

Construction: Steel. Add "C" for Stainless Steel.

Part Number	Thread Size	Hose I.D.		A		Cutoff Allow. B		H Hex inch
		inch	mm	inch	mm	inch	mm	
1PCY-2-2	3/4"-16 UNF	1/8	3	2.40	61	1.875	48	1

F Tooling, Equipment & Accessories

WARNING This product can expose you to chemicals including Lead, which is known to the State of California to cause cancer and birth defects or other reproductive harm. For more information go to www.P65Warnings.ca.gov.

G General Technical

Fittings - Permanent

MS Series

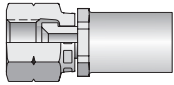
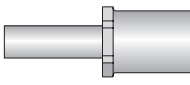
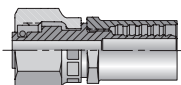
MS Series	108	SAE 45° Swivel	134	Straight Tube	1TF	Marine Tube Connector
Permanent						
	E-80		E-80		E-80	

NOTE: MS Series is also available in a field-attachable design. The fittings are listed with the field-attachable fittings, page E-32.

108MS Permanent SAE 45° Swivel (Brass)

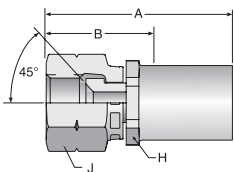

Construction: Brass.

Part Number	Thread Size	Hose I.D.		A		Cutoff Allow. B		H Hex inch	J Hex inch
		inch	mm	inch	mm	inch	mm		
108MS-6-5B	5/8-18	5/16	8	1.75	45	1-1/8	29	5/8	13/16
108MS-6-6B	5/8-18	3/8	10	1.82	46	1-1/16	27	3/4	13/16

134MS Permanent Straight Tube (Brass)

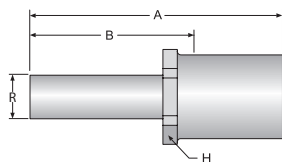

Construction: Brass.

Part Number	Diameter R	Hose I.D.		A		Cutoff Allow. B		H Hex inch
		inch	mm	inch	mm	inch	mm	
134MS-6-5B	3/8	5/16	8	2.00	51	1-3/8	35	5/8
134MS-6-6B	3/8	3/8	10	2.08	53	1-3/8	35	3/4

1TFMS Permanent Marine Tube Connector (Brass)

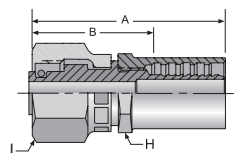

Construction: Brass.

Part Number	Thread Size	Hose I.D.		A		Cutoff Allow. B		J Hex inch	H Hex inch
		inch	mm	inch	mm	inch	mm		
1TFMS-6-5B	9/16-24	5/16	8	1.70	43	1 1/16	27	3/4	5/8

NOTE: Nitrile O-ring.

Connector Mates are Manufactured by the Fluid Systems Connection Division. Refer to Catalog 3501E for Ordering, Installation Instructions and Replacement Components.



WARNING

This product can expose you to chemicals including Lead, which is known to the State of California to cause cancer and birth defects or other reproductive harm. For more information go to www.P65Warnings.ca.gov.

Fittings - Permanent Crimp

SF Series

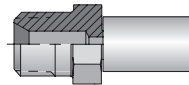
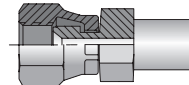
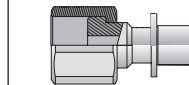
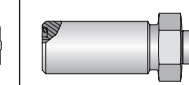
SF Series	101	106	1JS	1JB
Permanent	Male Taper Pipe Rigid	JIC 37° Swivel	Female Seal-Lok™ Swivel Long	Male Seal-Lok™ Bulkhead w/O-ring
				
	E-81	E-81	E-81	E-81

101SF Male Taper Pipe Rigid

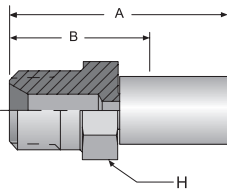

Construction: Steel. Add "C" for Stainless Steel.

Part Number	Thread Size	Hose I.D.		A		Cutoff Allow. B		H Hex
		inch	mm	inch	mm	inch	mm	inch
101SF-2-1	1/8-27	0.090	2.3	1.13	29	3/4	19	7/16

106SF JIC 37° Swivel

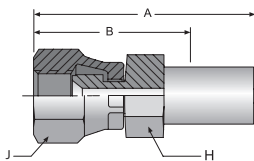

Construction: Steel. Add "C" for Stainless Steel.

Part Number	Thread Size	Hose I.D.		A		Cutoff Allow. B		H Hex	J Hex
		inch	mm	inch	mm	inch	mm	inch	inch
106SF-2-1	5/16-24	0.090	2.3	1.37	35	15/16	24	7/16	1/2

1JSSF Female Seal-Lok™ Swivel Long

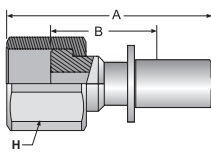

Construction: Steel. Add "C" for Stainless Steel.

Part Number	Thread Size	Hose I.D.		A		Cutoff Allow. B		H Hex
		inch	mm	inch	mm	inch	mm	inch
1JSSF-4-1	9/16-18	0.090	2.3	1.18	29.8	3/4	19	11/16

1JBSF Male Seal-Lok™ Bulkhead with O-ring

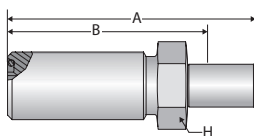

Construction: Steel. Add "C" for Stainless Steel.

Part Number	Thread Size	Hose I.D.		A		Cutoff Allow. B		H Hex
		inch	mm	inch	mm	inch	mm	inch
1JBSF-4-1	9/16-18	0.090	2.3	2.06	52	1-11/16	43	5/8

NOTE: Bulkhead Locknut sold separately.
WNL Locknuts are manufactured by the Tube Fittings Division. Refer to Catalog 4300 for information.

WARNING
This product can expose you to chemicals including Lead, which is known to the State of California to cause cancer and birth defects or other reproductive harm. For more information go to www.P65Warnings.ca.gov.

Fittings - Permanent

SQ Series

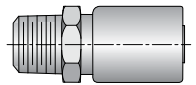
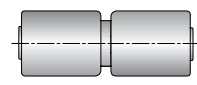
SQ Series Permanent	101	Male Taper Pipe Rigid	1HU	SQ Mender
	 E-82		 E-82	

101SQ Male Taper Pipe Rigid

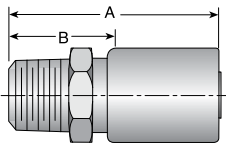

Construction: Steel.

Part Number		Hose I.D.		A		Cutoff Allow. B	
Hose	Fitting	inch	mm	inch	mm	inch	mm
S612	101SQ-12-12	3/4	19	3.08	78	1-1/2	38
S616	101SQ-16-16	1	25	3.42	87	1-13/16	46
S912	101SQ-12-12	3/4	19	3.08	78	1-1/2	38
S916	101SQ-16-16	1	25	3.42	87	1-13/16	46

NOTE: See pg. F-14 for swage die selection. See pg. G-16 for assembly instructions.

1HUSQ Mender

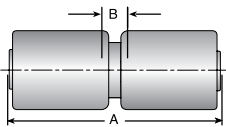

Construction: Steel.

Part Number		Hose I.D.		A		Cutoff Allow. B	
Hose	Fitting	inch	mm	inch	mm	inch	mm
S612	1HUSQ-12-12	3/4	19	3.7	94	9/16	14
S616	1HUSQ-16-16	1	25	3.99	101	9/16	14
S912	1HUSQ-12-12	3/4	19	3.7	94	9/16	14
S916	1HUSQ-16-16	1	25	3.99	101	9/16	14

NOTE: See pg. F-14 for swage die selection. See pg. G-16 for assembly instructions.

WARNING

 This product can expose you to chemicals including Lead, which is known to the State of California to cause cancer and birth defects or other reproductive harm. For more information go to www.P65Warnings.ca.gov.



Tooling, Equipment & Accessories

Accessories
Pumps

Hose Guards

Crimpers

Table of Contents

Crimpers

Accessories

MiniKrimp™F-4
 MiniKrimp™ Upgrade Kit.....F-5
 MiniKrimp Accessories.....F-6
 MiniKrimp Model Details & Parts.....F-8

Karrykrimp.....F-10
 Karrykrimp 2.....F-11

Parkrimp 2F-12

Air Over Hydraulic PumpsF-13
 Electric Pumps.....F-14
 Hand PumpsF-13

Hose Guards.....F-16
 Hose CuttersF-19

Parkrimp Dies.....F-15
 Vice & Insertion Blocks.....F-15

SQ-101-SW Swager/MenderF-14

Visual Index







Crimpers and Crimper Accessories

Minikrimp 94C-001-PFD  F-4	Minikrimp Hydraulic Pump Upgrade Kit  F-5	Karrykrimp 82C-061L-PFD  F-10	Karrykrimp Bench Mount 82C-KKB-PFD  F-10	Karrykrimp 2 85C-061L-PFD  F-11
Karrykrimp 2 Bench Mount 85C-KKB-PFD  F-11	Parkrimp 2 83C-081-PFD  F-12	Minikrimp Mounts  F-6	Minikrimp High Pressure Hose Assemblies  F-6	Minikrimp Hose Stand  F-7
Minikrimp Replacement Connectors  F-7				

Table of Contents

Visual Index

Pumps

Hand Pump 015301	Hand Pump 82C-0HP-PFD	Hand Pump 85C-0HP-PFD	Air/Hydraulic Pump 025399	Air/Hydraulic Pump 82C-0AP
 F-13	 F-13	 F-13	 F-13	 F-13
Hand Pump 015301	Hand Pump 82C-0HP-PFD			
 F-14	 F-14			

Sewer Hose Swager

Swager Mender SQ-101-SW
 F-14

Accessories

Dies	Vise Blocks VBS & VBL	Insertion Block TH-9-1-xxx	Hose Guard PV Clear Vinyl	Hose Guard HBR
 F-15	 F-15	 F-15	 F-16	 F-16
Hose Guard 5CNG CNGG Guard Kit	Hose Guard PSG / SSG Pre-Made Spring	Hose Guard -SG Pre-made	Hose Guard PTFE -AS Hose Guard	Hose Guard PTFE -2613 Inter. Flat Spring Guard
 F-16	 F-16	 F-17	 F-17	 F-17
Hose Guard FS Fire Sleeve	Hose Guard PSG Parker Spiral Guard	Hose Cutoff Machine 332T-115V	Push-Lok Cut-Off 881540	Hose Cutter HTC
 F-17	 F-18	 F-19	 F-19	 F-19
Hose Cutter TH11-1	Plastic Tube Cutter PTC	PST - Parker Skive Tool		
 F-19	 F-20	 F-20		

A
Hose

B
Tubing

C
Coiled Air Hose
& Fittings

D
Transportation

E
Fittings

F
Tooling,
Equipment
& Accessories

G
General
Technical

Crimpers

MiniKrimp™ Hand Pump and Air Over Hydraulic

Weighing in at a light 42 pounds,
the strongest portable crimper on the market.



Features

- Lightweight, portable, compact all-in-one unit
- Hand unit with pump weighs only 42 pounds; Air unit weighs 45 pounds
- 10,000 psi and 30+ tons of force
- No gauges to set - exclusive Parkalign™ feature positions the fitting correctly every time
- Removable pusher design for easy die change
- Hand pump easily removed for use with jumper hose for bench-mounted units (Part No. 015309)
- Air pump utilizes a rugged activation and release lever for greater durability with no additional power source required for operation and can operate with as little as 60 psi air pressure (60-100 psi, 9 CFM recommended)
- Capable of crimping a majority of thermoplastic, rubber, PTFE and specialty hoses up to 3/4" I.D.
- For use with 56, 91, 91N, 92, 93N, CG, CY, MS, SF, 43 and HY Series fittings
- **Do not** use this machine to assemble any size 56, CG, 93N or 43 series Stainless Steel fitting. Use a minimum of a 60 ton crimp machine such as the KarryKrimp II

Hand Pump Specifications PN 94C-001-PFD

- Dimensions: 6" Deep, 13" Wide, 15" High
- Weight: 42 lbs with hand pump
- Rating: 30 tons force@10,000 psi maximum
- Full Cycle Time: Approximately 30 seconds

Note: Hydraulic Fluid - Enerpac HF oil only

Air/Hydraulic Pump Specifications PN 94C-002-PFD

- Dimensions: 6" Deep, 12" Wide, 15" High
- Weight: 45 lbs with air/hydraulic pump
- Rating: 30 tons force@10,000 psi maximum
- Full Cycle Time: Approximately 30 seconds

Note: Hydraulic Fluid - Enerpac HF oil only

Notes

- Reference CrimpSource on-line for detailed crimp specifications - www.parker.com/crimpsource

Minikrimp Standard Equipment

Part Number		Description	Individual Part Number
94C-001-PFD	94C-002-PFD		
●	●	Base unit	94C-080-PFD
●		Hand pump	015301
	●	Air over hydraulic pump	025399
●	●	Silver die ring	82C-R01-PFD

The MiniKrimp utilizes a one-piece, high-strength cast aluminum frame that is light, robust and highly corrosion resistant.



WARNING

This product can expose you to chemicals including Lead, which is known to the State of California to cause cancer and birth defects or other reproductive harm. For more information go to www.P65Warnings.ca.gov.

Crimpers

Air Over Hydraulic Pump Upgrade Kit, Part #025411



1. (IF APPLICABLE) Relieve pressure from attached pump. Remove the hand pump and bent tube assembly from the body of the crimper. Do not remove the adapter (6-6 CTX-S) from the cylinder. This adapter will be used, with an orientation change, with the Air Over Hydraulic Pump.
2. Screw (or reorient) the 6-6 CTX-S adapter into the cylinder port and tighten until the fitting is facing in the upward direction. Do not loosen the adapter to reach the correct orientation as this may cause leakage.
3. Apply appropriate thread sealant to taper pipe thread of 6-2 CTX-S adapter and screw into pump (2-3 turns) so that the fitting (male JIC connection) is facing the direction of the fill cap.
4. Mount the pump 025399 to the right side of the crimper as shown in the image to the left using two 1/4" bolt holes on the top of the crimper. Note that only the top two bolt holes are used.
5. Attach the 025349 bent tube assembly to the two adapters. The longer of the two ends of the tube will attach to the pump. Tighten the nuts of bent tube to a minimum of 20 ft.-lbs or 2-1/2 Flats from Wrench Resistance.
6. MiniKrimp is ready for operation. Reference the Enerpac pump manual for operating instructions.

Minikrimp Air Over Hydraulic Pump Upgrade Kit 025411

Part Number	Descriptions
025399	Air over Hydraulic Pump
025349	Stainless Steel Tube Connector
6-6 CTXS-PFD	Adapter
6-2 CTXS-PFD	Adapter

Refer to Catalog 4300 of the Parker Tube Fittings Division for Detail Assembly Instructions for the CTX Port Adapters referenced in Steps 2 and 3.



WARNING

This product can expose you to chemicals including Lead, which is known to the State of California to cause cancer and birth defects or other reproductive harm. For more information go to www.P65Warnings.ca.gov.

A
Hose

B
Tubing

C
Coiled Air Hose
& Fittings

D
Transportation

E
Fittings

F
Tooling,
Equipment
& Accessories

G
General
Technical

Crimpers

MiniKrimp™ Accessories

A Hose

B Tubing
Thermoplastic

C Coiled Air Hose
& Fittings

D Transportation

E Fittings

F Tooling,
Equipment
& Accessories

G General
Technical



Upright Vise Mount Part No. 015307

- Material - High Strength Steel
- Mount connects to the bottom of the MiniKrimp using (4) 3/8-16 18-8 SS SHCS 2.5" long bolts (not included)
- Once connected, the Minikrimp can be clamped into a vise for operation



Side Vise Mount Part No. 015736

- Material - High Strength Steel
- Mount connects to the side of the MiniKrimp using (4) 1/4-20 18-8 SS SHCS 1" long bolts (not included)
- Once connected, the Minikrimp can be clamped into a vise for operation



Table Mount Part No. 015306

- Material - High Strength Steel
- Mount connects to the bottom of the MiniKrimp using (4) 3/8-16 18-8 SS SHCS 2.5" long bolts (not included)
- Once connected, the Minikrimp can be mounted to a table using the (4) 3/8" clearance holes on the opposite side of the plate (bolts not included)



High Pressure Hose Assembly Part No. 045234

- Parker 10,000 psi, 1/4" ID hose assembly with bend restrictors and 3000 series quick disconnects (PN - 2022N0101060404-36BR with 3050-2/3010-2 coupler and nipple)
- Designed to be used when mounting a hand pump (015301) to the MiniKrimp stand (94C-MKS) base

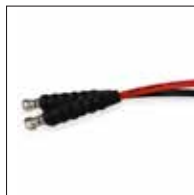

High Pressure Hose Assembly Part No. 015309

- Parker 10,000 psi, 1/4" I.D. hose assembly with 3/8" female JIC connections and bend restrictors on both ends (PN - 2022N0606060604-72BR)
- Hose is used when a flexible connection is required between the MiniKrimp and a hydraulic pressure source.

Note: The hydraulic connectors shown on this page are designed exclusively for use with the MiniKrimp. No other connectors are approved for use with the MiniKrimp without expressed written consent from Parker Parflex Division's technical support. Any worn connectors should be replaced immediately.



WARNING

This product can expose you to chemicals including Lead, which is known to the State of California to cause cancer and birth defects or other reproductive harm. For more information go to www.P65Warnings.ca.gov.

Crimpers

MiniKrimp™ Accessories



Folding Stand Part No. 94C-MKS

- Lightweight folding stand designed exclusively for the MiniKrimp portable crimper
- Fold up design is easy to store
- Mounting hardware and safety instructions are included
- Patented design



Hand Pump Replacement Connector Part No. 015308

- Replacement stainless-steel bent tube rigid connector
- For use with 94C-001-PFD (MiniKrimp Hand Pump Model)



Air Over Hydraulic Replacement Connector Part No. 025349

- Replacement stainless-steel bent tube rigid connector
- For use with 94C-002-PFD (MiniKrimp Air Over Hydraulic Model)



MiniKrimp with Hand Pump



Hand Pump MiniKrimp



Air Over Hydraulic MiniKrimp and Folding Stand

Note: The hydraulic connectors shown on this page are designed exclusively for use with the MiniKrimp. No other connectors are approved for use with the MiniKrimp without expressed written consent from Parker Parflex Division's technical support. Any worn connectors should be replaced immediately.



WARNING

This product can expose you to chemicals including Lead, which is known to the State of California to cause cancer and birth defects or other reproductive harm. For more information go to www.P65Warnings.ca.gov.

A Hose

B Tubing

C Coiled Air Hose & Fittings

D Transportation

M Fittings

Tooling, Equipment & Accessories

General Technical

Crimpers

MiniKrimp™ Detail - Hand Pump

A Hose

B Tubing
Thermoplastic

C Coiled Air Hose
& Fittings

D Transportation

E Fittings

F Tooling,
Equipment
& Accessories

G General
Technical



Hand Pump Model Details & Part List

Part No.	Description	Qty.
015301	2 Speed Light Weight Hand Pump	1
015302	Hardened Steel Sleeve	1
015303	Custom Cylinder	1
015304	Aluminum Frame	1
015305	Cup Pusher	1
015306	Bent Tube Assembly	1
015310	3/8" x 3/8" Shoulder Bolt	1
015415	Spring Plunger	1
6 CTX-S	3/8" 37° to 1/4" NPT Elbow	1
6-6 CTX-S	3/8" 37° to 3/8" NPT Elbow	1
822011	Die Separator	1
822012	Spring	1
822031	Retention Ring	1
82C-R01-PFD	Silver Die Ring	1
015411	3/8-16 18-8 SS SHCS 2.5" Long	2
015413	1/4-20 18-8 SS Lock Washer	2
015414	1/4-20 18-8 SS Flat Washer	2
015412	1/4-20 18-8 SS SHCS .75" Long	4

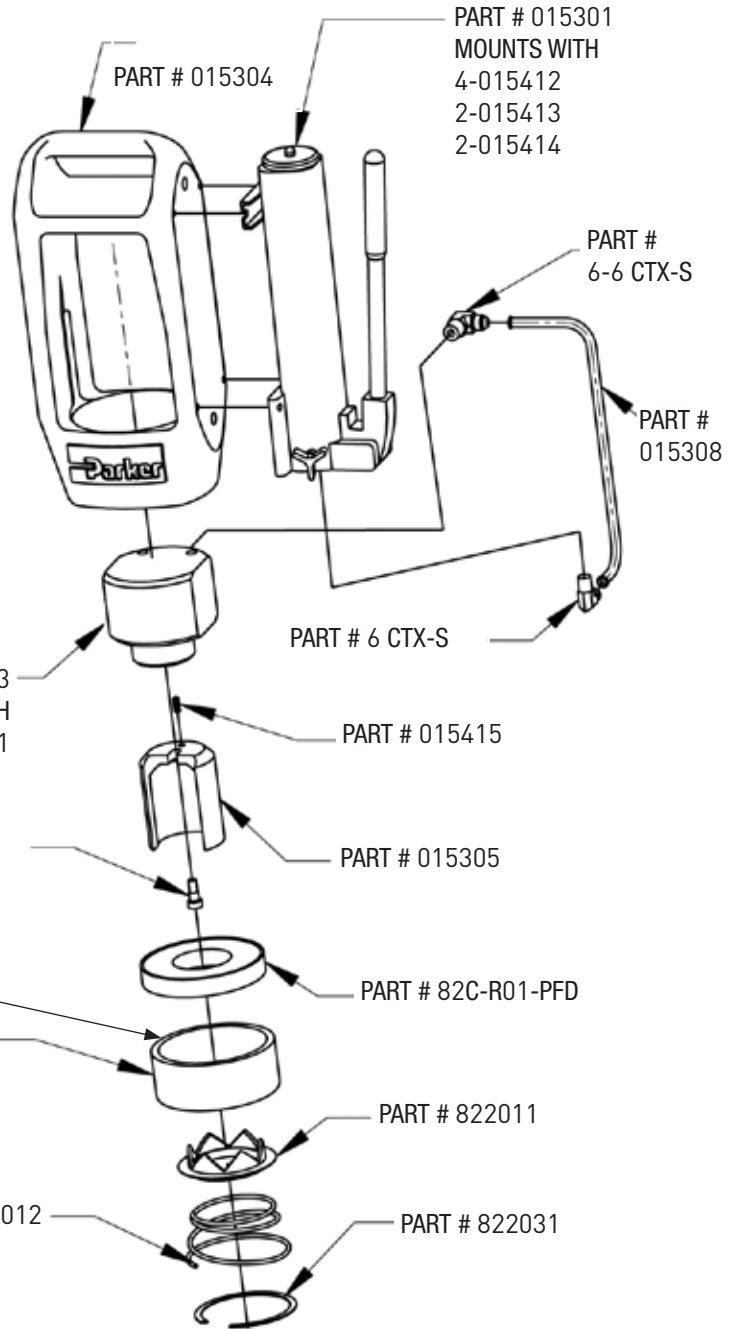

MiniKrimp™ Serial Number



WARNING

This product can expose you to chemicals including Lead, which is known to the State of California to cause cancer and birth defects or other reproductive harm. For more information go to www.P65Warnings.ca.gov.

Crimpers

MiniKrimp™ Detail - Air Over Hydraulic

A
Hose



B
Tubing

C
Coiled Air Hose & Fittings

D
Transportation

E
Fittings

F
Tooling, Equipment & Accessories

G
General Technical

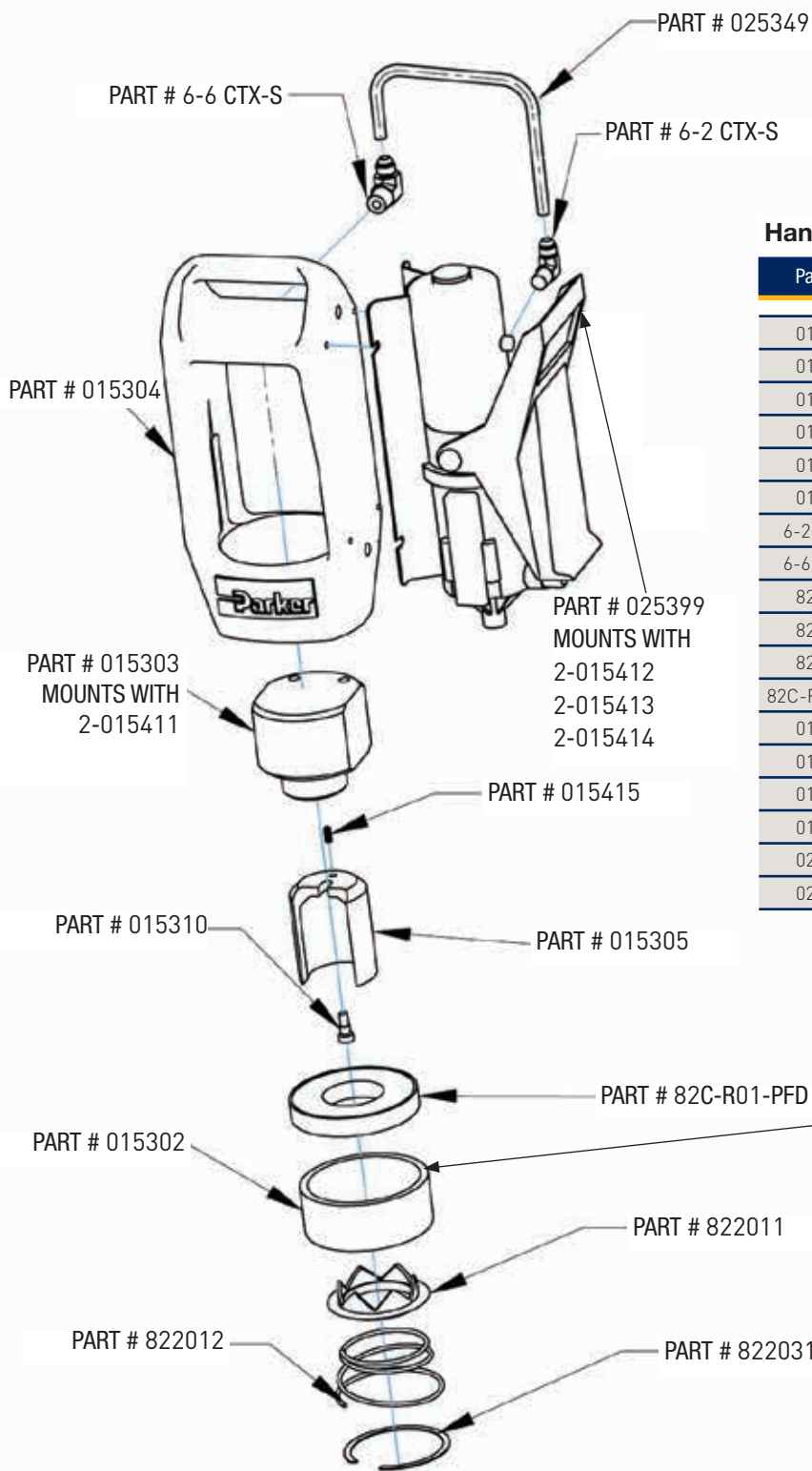

Hand Pump Model Details & Part List

Part No.	Description	Qty.
015302	Hardened Steel Sleeve	1
015303	Custom Cylinder	1
015304	Aluminum Frame	1
015305	Cup Pusher	1
015310	3/8" x 3/8" Shoulder Bolt	1
015415	Spring Plunger	1
6-2 CTX-S	3/8" 37° to 1/8" NPT Elbow	1
6-6 CTX-S	3/8" 37° to 3/8" NPT Elbow	1
822011	Die Separator	1
822012	Spring	1
822031	Retention Ring	1
82C-R01-PFD	Silver Die Ring	1
015411	3/8-16 18-8 SS SHCS 2.5" Long	2
015413	1/4-20 18-8 SS Lock Washer	2
015414	1/4-20 18-8 SS Flat Washer	2
015412	1/4-20 18-8 SS SHCS .75" Long	2
025349	Bent Tube Assembly	1
025399	Air Powered Pump	1

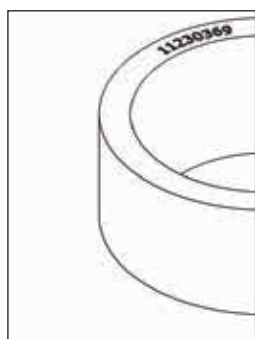

MiniKrimp™ Serial Number

WARNING This product can expose you to chemicals including Lead, which is known to the State of California to cause cancer and birth defects or other reproductive harm. For more information go to www.P65Warnings.ca.gov.

Crimpers

Karrykrimp

Bench mounted design features fastest cycle time.



Features

- Portable, compact rugged design
- Compact bench mount design features faster cycle times
- Numerous portable power unit options available
- Pivoting pusher design for easy die change out
- Increased height enables longer bent tube fittings to be crimped
- Crimps most hoses up to 1-1/4 I.D.
- For use with 56, 91, 91N, 92, 93N, CG, CY, MS, SF, 43 and HY Series fittings
- **Do not** use this machine to assemble any size 56, CG, 93N or 43 series Stainless Steel fitting. Use a minimum of a 60 ton crimp machine such as the KarryKrimp II

Portable Unit Specifications PN 82C-061L-PFD

- Dimensions: 12" Deep, 15" Wide, 30" High
- Weight: 70 lbs with power unit
- Rating: 30 tons force@10,000 psi maximum
- Full Cycle Time: 30 seconds

Bench Mounted Unit Specifications PN 82C-KKB-PFD

- Dimensions: 23" Deep, 19" Wide, 27-1/2" High
- Weight: 220 lbs
- Rating: 30 tons force@10,000 psi maximum
- Full Cycle Time: 15 seconds
- Hydraulic Fluid: Enerpac HF oil only

Notes

- *Mounted unit is designed to make about 200 crimps per day and is not designed to be a production crimper. Exceeding these suggested production amounts will significantly reduce the life expectancy of the crimper components
- Motor is dual voltage, 50/60hz suitable for 208-230/115v. Motor can be rewired by a qualified electrician to operate at alternate voltage
- Reference CrimpSource on-line for detailed crimp specifications - www.parker.com/crimpsource

Karrykrimp Standard Equipment

Crimper Part Number			Description	Individual Part Number
82C-CHD-PFD	82C-061L-PFD	82C-KKB-PFD		
●	●	●	Crimp Head	82C-CHD-PFD
		●	Bench Power Unit Assembly	85C-ZMS-PFD
●	●	●	Silver Die Ring	82C-R01-PFD
●	●	●	Black Die Ring	82C-R02-PFD
	●		Hose Assembly	85C-00L-PFD
	●		Stand Assembly	85C-STD-PFD
		●	Hose Assembly	85C-03L-PFD



WARNING

This product can expose you to chemicals including Lead, which is known to the State of California to cause cancer and birth defects or other reproductive harm. For more information go to www.P65Warnings.ca.gov.

Crimpers

Karrykrimp 2

The same unit now offers portability and bench mountability.



Features

- Portable, compact rugged design
- Bench mount design features faster cycle times
- Numerous portable power unit options available
- Pivoting pusher design for easy die change out
- Crimps most hoses up to 1-1/4 I.D.
- For use with 56, 91, 91N, 92, 93N, CG, CY, MS, SF, 43 and HY Series fittings

Portable Unit Specifications PN 85C-061L-PFD

- Dimensions: 14" Deep, 14" Wide, 31-1/2" High
- Weight: 120 lbs without power unit
- Rating: 60 tons force@10,000 psi maximum
- Full Cycle Time: 15 seconds

Bench Mounted Unit Specifications PN 85C-KKB-PFD

- Dimensions: 24" Deep, 19" Wide, 28" High
- Weight: 265 lbs
- Rating: 60 tons force@10,000 psi maximum
- Full Cycle Time: 15 seconds
- Hydraulic Fluid: Enerpac HF oil only

Notes

- *Mounted unit is designed to make about 400 crimps per day and is not designed to be a production crimper. Exceeding these suggested production amounts will significantly reduce the life expectancy of the crimper components
- Motor is dual voltage, 50/60hz suitable for 208-230/115v. Motor can be rewired by a qualified electrician to operate at alternate voltage
- Reference CrimpSource on-line for detailed crimp specifications - www.parker.com/crimpsource

Karrykrimp 2 Standard Equipment

Crimper Part Number			Description	Individual Part Number
85C-CHD-PFD	85C-061L-PFD	85C-KKB-PFD		
●	●	●	Crimp Head	85C-CHD-PFD
		●	Bench Power Unit Assembly	85C-ZMS-PFD
●	●	●	Silver Die Ring	85C-R01-PFD
●	●	●	Black Die Ring	85C-R02-PFD
	●		Hose Assembly	85C-00L-PFD
	●		Stand Assembly	85C-STD-PFD
		●	Hose Assembly	85C-03L-PFD



WARNING

This product can expose you to chemicals including Lead, which is known to the State of California to cause cancer and birth defects or other reproductive harm. For more information go to www.P65Warnings.ca.gov.

Crimpers

Parkrimp 2

Crimps hoses up to 2" I.D.



Features

- Easy to use vertical design
- Crimps full range of Parker hoses from 1/8" through 2" I.D.
- For use with 56, 91, 91N, 92, 93N, CG, CY, MS, SF, 43 and HY Series fittings

Unit Specifications

PN 83C-081-PFD

- Dimensions: 24" Deep, 31" Wide, 77" High
- Weight: 842 lbs (Head is 558 lbs and base is 284 lbs)
- Rating: 125 ton force@5,000 psi maximum
- Full Cycle Time: 30 seconds without adapter bowl
20 seconds with adapter bowl
- Hydraulic oil: Enerpac HF oil only

Notes

- Reference CrimpSource on-line for detailed crimp specifications - www.parker.com/crimpsource

Parkrimp 2 Standard Equipment

Crimper Part Number		Description	Individual Part Number
83C-081-PFD	83C-082-PFD		
●	●	Parkrimp 2 Crimper Head Assembly	83C-080-PFD
●		Parkrimp 2 Stand Assembly with 230/460 volt, 3 phase, 50/60 Hz power unit (wired for 230 volt)	83C-S40-PFD
	●	Parkrimp 2 Stand Assembly with 230 volt, 1 phase, 50/60 Hz power unit	83C-S20-PFD
●	●	Adapter Bowl	83C-OCB-PFD
●	●	Spacer Ring	83C-R02-PFD
●	●	Spacer Plates	83C-R02H-PFD



WARNING

This product can expose you to chemicals including Lead, which is known to the State of California to cause cancer and birth defects or other reproductive harm. For more information go to www.P65Warnings.ca.gov.

Accessories

Air/Hydraulic & Hand Pumps

Use only with the MiniKrimp



Air/Hydraulic Pump Part No. 025399

- Lightweight pump operates with 80-110 psi shop air pressure and delivers 10,000 psi
 - Length: 13"
 - Width: 4-1/2"
 - Height: 5"
 - Intake Port Size: 1/4" NPTF
 - Output Port Size: 1/8" NPTF
 - Weight: 12 lbs.
 - Hydraulic Fluid: Enerpac oil only



Hand Pump Part No. 015301

- Ease of operation hand pump delivers 10,000 psi
 - Length: 13-3/8"
 - Width: 3-1/4"
 - Height: 3-5/8"
 - Port Size: 1/4" NPTF
 - Weight: 4.7 lbs.
 - Hydraulic Fluid: Enerpac oil only

Use with the MiniKrimp, Karrykrimp and Karrykrimp 2



Air/Hydraulic Pump Part No. 82C-0AP-PFD

- Lightweight pump operates with 80-110 psi shop air pressure and delivers 10,000 psi
 - Length: 15"
 - Width: 6"
 - Height: 6"
 - Intake Port Size: 1/4" NPTF
 - Output Port Size: 3/8" NPTF
 - Weight: 14 lbs.
 - Hydraulic Fluid: Enerpac HF oil only



Hand Pump Part No. 82C-0HP-PFD

- Ease of operation hand pump delivers 10,000 psi
 - Length: 23"
 - Width: 4"
 - Height: 5"
 - Port Size: 3/8" NPTF
 - Weight: 9.0 lbs.
 - Hydraulic Fluid: Enerpac oil HF only



Hand Pump Part No. 85C-0HP-PFD

- Ease of operation hand pump delivers 10,000 psi
 - Length: 29"
 - Width: 13"
 - Height: 11"
 - Port Size: 3/8" NPTF
 - Weight: 61 lbs.
 - Hydraulic Fluid: Enerpac oil only



WARNING

This product can expose you to chemicals including Lead, which is known to the State of California to cause cancer and birth defects or other reproductive harm. For more information go to www.P65Warnings.ca.gov.

A
Hose

B
Tubing

C
Coiled Air Hose
& Fittings

D
Transportation

E
Fittings

F
Tooling,
Equipment
& Accessories

G
General
Technical

Accessories

Electric Pumps

Use with the MiniKrimp, Karrykrimp and Karrykrimp 2



Electric Part No. 82C-0EP-PFD

- Ease of operation electric pump delivers 10,000 psi
 - Length: 13" Weight: 31 lbs.
 - Width: 13" Hydraulic Fluid: Enerpac oil only
 - Height: 15" 115 volt, 1 phase, 50/60 Hz, 9 amp
 - Port Size: 3/8" NPTF



Electric Part No. 85C-0EP-PFD

- Heavy duty electric pump delivers 10,000 psi at a faster cycle time
 - Length: 19" Weight: 59 lbs.
 - Width: 11" Hydraulic Fluid: Enerpac oil only
 - Height: 17" 115 volt, 1 phase, 50/60 Hz, 20 amp
 - Port Size: 3/8" NPTF

Swagers

Swager/Mender



Swager/Mender Part No. SQ-101-SW

- Used for field assembly or repair on Predator S5N, S6 and S9 hoses

Swage Data For Sewer Cleaning Hose

(SQ-101-SW SWAGE MACHINE ONLY)

Hose Type.	Hose I.D.	Male Pipe			Mender/Splicer		Swage O.D. +/- .015 inch	Swage Length inch
		Fitting Part Number	Die Part Number	Pusher Part Number	Fitting Part Number	Die Part Number		
S508N	1/2	-	-	-	1HU55-8-8	SQ-101-08S5S	0.850	0.750
S612	3/4	101SQ-12-12	SQ-101-12S6/S9	SQ-101-12P	1HUSQ-12-12	SQ-101-12S6/S9	1.172	1.109
S616	1	101SQ-16-16	SQ-101-16S6	SQ-101-16P	1HUSQ-16-16	SQ-101-16S6	1.445	1.156
S912	3/4	101SQ-12-12	SQ-101-12S6/S9	SQ-101-12P	1HUSQ-12-12	SQ-101-12S6/S9	1.172	1.109
S916	1	101SQ-16-16	SQ-101-16S9	SQ-101-16P	1HUSQ-16-16	SQ-101-16S9	1.488	1.156

Comments:

- Two dies required when swaging a mender/splicer fitting. A pusher is not required when swaging a mender/splicer fitting
- One die and one pusher required when swaging a male pipe fitting. For end fitting attachment, reference www.parker.com/crimpsource
- End fittings cannot be swaged on S5N series hose. Only mender/splicers can be swaged

The information covered in the Swage Specification & Tool Selection Chart pertains to steel hose fittings. Swage diameter roundness shall not vary by more than .010". Swage diameters are measured in the center of the swage area. Parflex Division reserves the right to alter swage specifications.



WARNING

This product can expose you to chemicals including Lead, which is known to the State of California to cause cancer and birth defects or other reproductive harm. For more information go to www.P65Warnings.ca.gov.

Accessories

Parkrimp Dies



Parkrimp Dies

- Parkrimp dies, specifically engineered for thermoplastic and fluoropolymer hose:
 - Linked die segments
 - Pre-matched and assembled
 - Fitting size color coded

Approved Silver Die Rings

Approved Die	Machine
NA*	Parkrimp 2
82C-R01-PFD	Karrykrimp and MiniKrimp
85C-R01-PFD	Karrykrimp 2

* No additional silver die rings required.

Note: Parflex dies have been designed for use with the silver die ring. Silver die rings are to be used with all Parflex hoses unless otherwise specified.

For most Parker products, Crimp Die information and selection charts can be found online at www.parker.com/crimpsource.

Colors

Color Code

Size	Color
-1.5	Gray
-2	Brown
-3	Gray
-4	Red
-5	Purple
-6	Yellow
-8	Blue
-10	Orange
-12	Green
-16	Black
-20	White
-24	Red
-32	Green

Vice & Insertion Depth Blocks



Vise Blocks for Parflex Hose Sizes

Part No.	Hose Size
VBS	-2 1/8
	-3 3/16
	-4 1/4
	-5 5/16
	-6 3/8
	-8 1/2

Part No.	Hose Size
VBL	-12 3/4
	-16 1



Hose Insertion Depth Blocks Part No. TH9-1-xxx

Part No.	Description
TH9-1-CG	CG Series. All sizes.
TH9-1-56	56 Series. All sizes.
TH9-1-91N	91N Series. All sizes.
TH9-1-93N_20-32	93N Series. Sizes: -20 to -32
TH9-1-93N_6-16	93N Series. Sizes: -6 to -16

Part No.	Description
TH9-1-94_95	94 & 95 Series. All sizes.
TH9-1-CY_SF	CY & SF Series. All sizes.
TH9-1-MS	MS Series. All sizes.
TH9-1-HY	HY Series. All sizes.



WARNING

This product can expose you to chemicals including Lead, which is known to the State of California to cause cancer and birth defects or other reproductive harm. For more information go to www.P65Warnings.ca.gov.

Accessories

Hose Guards

A Hose

B Thermoplastic Tubing

C Coiled Air Hose & Fittings

D Transportation

E Fittings

F Tooling, Equipment & Accessories

G General Technical



PV - Clear Vinyl Hose Guard

Part Number	Guard I.D.		Standard Length	
	inch	mm	feet	meter
PV97-1	0.44	11	100	30.5
PV139-1	0.56	14	100	30.5
PV1611-1	0.68	17	100	30.5

Part Number	Guard I.D.		Standard Length	
	inch	mm	feet	meter
PV2014-1	0.87	22	50	15.2
PV2420-1	1.25	32	50	15.2
PV3224-1	1.5	38	50	15.2



HBR - Hose Bend Restrictor (Black Elastomer)

Part Number	Hose Size		L		D1		D2	
	inch	mm	inch	mm	inch	mm	inch	mm
HBR-4	1/4	6	5	127	0.6	15	0.5	13
HBR-6	3/8	10	6	152	0.64	16	0.625	16

- Parker reserves the right to change dimensions and performance parameters without notice



5CNG/5CNGLT - Black Vinyl CNG Hose Guard

Hose Part No.	Hose Guard Part No.	Hose Part No.	Hose Guard Part No.
5CNG-4	CNGG5-4	5CNG/5CNGLT-12	CNGG5-12
5CNG-6	HBR-6	5CNG-16	CNGG5-16
5CNG-8	CNGG5-8		

- Use with Parflex CNG hose



SSG Pre-made Spring Guards - Plated, hard-drawn steel wire

Part Number	Guard I.D.		Standard Length	
	inch	mm	inch	mm
55SSG-3	0.44	11	6	152
55SSG-4	0.55	14	6	152
55SSG-5	0.61	15	6	152

Part Number	Guard I.D.		Standard Length	
	inch	mm	inch	mm
55SSG-6	0.68	17	6	152
55SSG-8	0.83	21	6	152
55SSG-12	1.09	28	7	178



PSG Pre-made Spring Guards - For CNG Hose - Stainless Steel

Part Number	Guard I.D.		Standard Length	
	inch	mm	inch	mm
3PSG-4	0.54	14	6.25	159
5PSG-4	0.57	14	6.25	159

Part Number	Guard I.D.		Standard Length	
	inch	mm	inch	mm
5PSG-6	0.68	17	6.5	165
5PSG-8	0.90	23	6.5	165



WARNING

This product can expose you to chemicals including Lead, which is known to the State of California to cause cancer and birth defects or other reproductive harm. For more information go to www.P65Warnings.ca.gov.

Accessories

Hose Guards

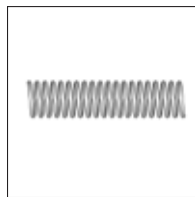

SG Pre-made Spring Guards - Plated, hard-drawn steel wire

Part Number	Guard I.D.		Standard Length		Part Number	Guard I.D.		Standard Length	
	inch	mm	feet	meter		inch	mm	feet	meter
55SG-3	0.47	12	25	7.6	55SG-6	0.67	17	25	7.6
55SG-4	0.55	14	25	7.6	55SG-8	0.83	21	25	7.6
55SG-5	0.61	16	25	7.6	55SG-12	1.09	28	10	3

Hose Guards for PTFE Hose



AS

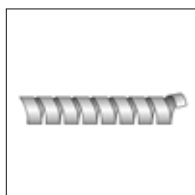

2613



FS

Hose	Max O.D. inch	Partek Sleeve	Internal Flat Spring	Fire Sleeve
919/929	-4	0.32	-	FS-F-5
	-5	0.40	-	FS-F-7
	-6	0.46	AS-Y-11/AS-B-11	FS-F-8
	-8	0.56	AS-Y-11/AS-B-11	2613-13CR FS-F-10
	-10	0.66	AS-Y-13/AS-B-13	2613-16CR FS-F-12
	-12	0.79	AS-Y-15/AS-B-15	2613-20CR FS-F-14
	-16	1.05	AS-Y-17/AS-B-17	2613-28CR FS-F-20
	-20	1.32	AS-Y-22/AS-B-22	2613-37CR FS-F-24
939	-4	0.48	AS-Y-11/AS-B-11	FS-F-10
	-6	0.59	AS-Y-13/AS-B-13	FS-F-11
	-8	0.75	AS-Y-15/AS-B-15	FS-F-14
	-10	0.88	AS-Y-17/AS-B-17	FS-F-16
	-12	1.09	AS-Y-19/AS-B-19	FS-F-20
	-16	1.33	AS-Y-27/AS-B-27	FS-F-24
	-20	1.75	AS-Y-35/AS-B-35	FS-F-32
	-24	2.05	AS-Y-39/AS-B-39	FS-F-38
943	-6	0.49	AS-Y-11/AS-B-11	FS-F-10
	-8	0.62	AS-Y-13/AS-B-13	2613-13CR FS-F-11
	-10	0.73	AS-Y-15/AS-B-15	2613-16CR FS-F-14
	-12	0.99	AS-Y-17/AS-B-17	2613-20CR FS-F-18
	-16	1.39	AS-Y-27/AS-B-27	2613-28CR FS-F-24

NOTE: Partek sleeves come in yellow and black.
All internal guards are fabricated from 300 series stainless steel.



WARNING

This product can expose you to chemicals including Lead, which is known to the State of California to cause cancer and birth defects or other reproductive harm. For more information go to www.P65Warnings.ca.gov.

Accessories

PSG Hose Guard

Superior anti-crush performance.
Easy installation.



Features

- High-strength and resilient, Parflex Spiral Guard (PSG) protects hose and cable with superior anti-crush performance
- Exceptionally smooth facing and rounded edges prevent spiral guard from getting caught on rough surfaces
- Easy installation and routing
- Low friction interior minimizes wear on hose
- Delivers more advantages than cut pipe or sleeving at a competitive price or less
- For bundling, organizing and protecting hose and cable, PSG is the superior solution for mining operations
- PSG is available in:
 - An MSHA/FRAS approved version for underground mining
 - A standard version (with yellow stripe) for surface applications not requiring fire-resistant, anti-static properties
- Manufactured with high density polyethylene materials

PSG Hose Guard

Part Number	Hose O.D. Range		Package Qty.		1-Wire Braid Size		2-Wire Braid Size		Multi-Spiral Size		Weight	
	mm	inch	meter	feet	inch	mm	inch	mm	inch	mm	lbs./ft.	kg/mtr
PSG-12	10 – 13	.394-.512	20	65.6	-	-	-	-	-	-	0.034	0.015
PSG-FRAS-16 or PSG-16	12 – 17	.472-.669	20	65.6	1/4	6	1/4	6	-	-	0.040	0.018
PSG-FRAS-20 or PSG-20	16 – 22	.630-.866	20	65.6	3/8	10	1/4 3/8	6 10	3/8	10	0.060	0.027
PSG-FRAS-25 or PSG-25	22 – 28	.866-1.10	20	65.6	1/2 5/8	13 16	1/2 5/8	13 16	1/2 5/8	13 16	0.101	0.046
PSG-FRAS-32 or PSG-32	27 – 33	1.06-1.30	20	65.6	3/4	19	5/8 3/4	16 19	5/8 3/4	16 19	0.151	0.068
PSG-FRAS-40 or PSG-40	33 – 42	1.30-1.65	20	65.6	1	25	1	25	1	25	0.235	0.107
PSG-FRAS-50 or PSG-50	42 – 55	1.65-2.17	20	65.6	1-1/4 1-1/2	32 38	1-1/4	32	1-1/4 1-1/2	32 38	0.268	0.122
PSG-FRAS-63 or PSG-63	52 – 65	2.05-2.56	20	65.6	2	51	1-1/2	38	1-1/2	38	0.402	0.182
PSG-FRAS-75 or PSG-75	65 – 80	2.56-3.15	10	32.8	-	-	2	51	2	51	0.637	0.289
PSG-FRAS-90 or PSG-90	80 – 150	3.15-5.91	10	32.8	-	-	-	-	-	-	0.771	0.350
PSG-FRAS-110 or PSG-110	150 – above	5.91-above	10	32.8	-	-	-	-	-	-	1.000	0.454



WARNING

This product can expose you to chemicals including Lead, which is known to the State of California to cause cancer and birth defects or other reproductive harm. For more information go to www.P65Warnings.ca.gov.

Accessories

Cutters



Hose Cut-Off Machine Part No. 332T-115V-PFD

- For quick, easy cutting of reinforced hose up to 1-1/4" I.D.
- Moving parts shielded by guards
- Dimensions: 13" wide x 26" long x 22" high
- Shipping Weight: 71 lbs.

Part No.	Description	Individual Part No.
332T-115V-PFD	Hose Cut-Off Machine with 1-1/2 HP, 3450 RPM, 115/230V single phase electric motor wired for 115V	332T-115V-PFD
	Scalloped Cutting Blade (8" with 5/8" arbor size)	24398-PFD
	Smooth Cutting Blade (8" with 5/8" arbor size)	580661-PFD



Push-Lok Cut-Off & Assembly Tool Part No. 881540-PFD

- Combines hose cutter and toggle action press
- Cuts and assembles Parker B9 and 83FR in sizes 1/4" through 3/4" I.D.



Hose & Tubing Cutter Part No. HTC

- Special V-block design with easy adjustable blade ensures a straight, clean cut
- Minimal flattening of hose/tubing during cutting - Straight, square cut enhances fitting retention
- Cuts up to 1" O.D. hose or tubing (Non-wire reinforced thermoplastic hose and tubing and rubber hose and tubing)
- Replacement blades: part no. HTC-RB



Hose Cut-Off Tool Part No. TH11-1-PFD

- Designed for quick, easy cutting of fiber reinforced hose
- Squarely cuts fiber reinforced hoses in sizes 1/4" through 3/4" I.D.



WARNING

This product can expose you to chemicals including Lead, which is known to the State of California to cause cancer and birth defects or other reproductive harm. For more information go to www.P65Warnings.ca.gov.

A Hose

B Tubing

C Coiled Air Hose & Fittings

D Transportation

F Fittings

Tooling, Equipment & Accessories

General Technical

Cutters

MiniKrimp™ Accessories

A Hose

B Tubing
Thermoplastic



Plastic Tube Cutter Part No. PTC

- Razor-edged tube cutter
- Closes automatically, assuring clean and square cuts
- May be used with most plastic tubing up to 5/8" I.D.
- Replacement blades: part no. PTC-001-RB

C Coiled Air Hose
& Fittings



Parflex Skive Tool Part No. PST

- Removes outer jacket on two layered construction tubing without damaging inner tube
- Use with Parflex 95FR tubing in sizes 1/4" through 1/2" I.D.

D Transportation

E Fittings

F Tooling,
Equipment
& Accessories

G General
Technical



WARNING

This product can expose you to chemicals including Lead, which is known to the State of California to cause cancer and birth defects or other reproductive harm. For more information go to www.P65Warnings.ca.gov.



General Technical

Instructions

Safety

Warranties

Table of Contents

Hose Assembly & Crimping

Using Crimpsource G-3

Permanent Crimp G-4
Series 56, CG, 92, CY, MS, SF

Field Attachable.....G-8
Series 51, 51R, BU, MS

PTFE Permanent Crimp G-9
Series 91, 91N, 93N

PTFE Permanent Crimp G-11
Series PAGE

PTFE Field Attachable G-13
Series 90

Sewer Hose Swaged G-15
Series SQ

Hose Handling

Twin/Multi-Line Separation..... G-17

Safety/Warranties

Parker Safety Guide G-19

Enerpac Warranty G-23

Offer of sale..... G-24

Index

By part number G-25

By keyword..... G-29



Parflex[®]
Partner. Innovator. Leader.

A Hose

B Tubing Thermoplastic

C Coiled Air Hose & Fittings

D Transportation

E Fittings

F Tooling, Equipment & Accessories

G General Technical

Hose Assembly and Crimping

How To Use Crimpsource

1

Data



The most up-to-date information for crimping is located at www.parker.com/crimpsource. Not only is it accurate, but it is easy.

Note

- ✓ If the hose does not come up, then you cannot crimp that hose on the machine you selected.
- ✓ If the fitting/size you choose doesn't come up, then that series is not available for that hose.

www.parker.com/crimpsource

2

Make Your Selections

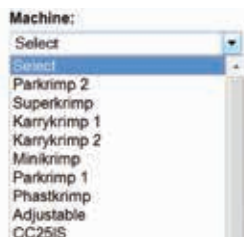

Choose the correction machine.



Choose the hose you are crimping.

Note - If the hose does not come up, then the crimper chosen does not work with the selected hose.

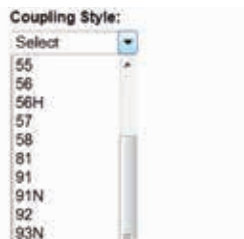

Choose the fitting style.



Choose the fittings size. Once you have selected values from each field, hit the search button.

Note - If the fitting/size does not come up, the series and or size is not available for the selected hose.

3

Review the Results

Part	80C-P08	82C-R01	0.850	FULL	1-1/8	PKFull
Comments	PFD: Crimp diameter is measured four places, 45 degrees apart, at the top, then middle and bottom of the crimp. PFD: Crimp diameter tolerance on all Parkrimp Crimpers is $\pm 0.010"$ ($\pm 0.25\text{mm}$) unless otherwise specified. Crimp length tolerance is $\pm 0.030"$ ($\pm 0.76\text{mm}$). PFD: Align measurement caliper or micrometer on the center of crimp impressions avoiding the crimp ribs. PFD: Crimp diameter tolerance on all Adjustable Crimpers is $\pm 0.005"$ ($\pm 0.13\text{mm}$). Crimp length tolerance is $\pm 0.030"$ ($\pm 0.76\text{mm}$).					

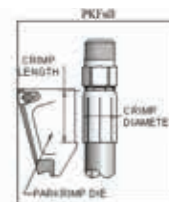

Hose Assembly and Crimping

Permanent Crimp - Series 56, CG, 92, CY, MS, SF

CAUTION

There are several sections for Hose Assembly and Crimping. **Be sure you are in the section that corresponds to the fitting series you are using.** See Table of Contents for listing.

1

Inspection



Hose – Visually inspect both ends of hose for square cut. Remove any burrs, loose fibers or wires.



Fittings – Verify fitting series corresponds to the selected hose. Visually inspect fitting(s) for a through-hole, threads and damage.

2

Assembly Prep



Insertion Depth – Mark hose end with proper insertion depth line. Shown is a 56 Series fitting. See Hose Fitting Insertion Values, pg. E-10 for insertion depths of fitting series that do not incorporate an insertion depth.



Lubrication (as required) – Using an SAE 20 weight lubricating oil, lightly lubricate inside of hose end.

Warning Do not use lubricating oil when installing fittings on hose used in breathing air systems.

When installing fittings on hose used in breathing air systems, lubricate with a non-oil based soap solution as failure to do so may result in personal injury.

3

Assembly



Assemble Hose – Push hose into fitting all the way to depth insertion mark.

If fitting does not readily slide onto hose, perform the next step.



Using Parker VBS or VBL (vise blocks) and a rubber mallet, tap fitting onto hose until bottom of fitting shell is aligned with depth insertion mark.

4

Die Selection

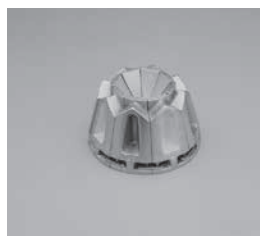

Select proper Parkrimp die set.

Reference Crimp Die Selection at Crimpsource online.

www.parker.com/crimpsource

5

Lubricate Bowl



Grease frequently using a premium, quality, lithium-based grease. Apply a thin layer of grease on bowl of crimper base plate.

Hose Assembly and Crimping

Permanent Crimp - Series 56, CG, 92, CY, MS, SF

CAUTION

There are several sections for Hose Assembly and Crimping. **Be sure you are in the section that corresponds to the fitting series you are using.** See Table of Contents for listing.

6

Die and Spacer Ring

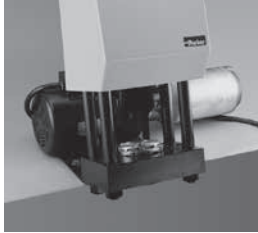

Crimp Die – Place die set into bowl.

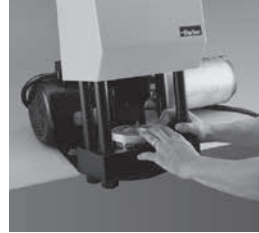

Die Ring – Place applicable die ring on top of crimp die. Position die ring so it is centered on the crimp die. Parflex utilizes the Silver die ring (8XC-R01) with limited exception.

Reference proper tooling (crimp die and die ring) at Crimpsource on-line.

www.parker.com/crimpsource

7

Crimp

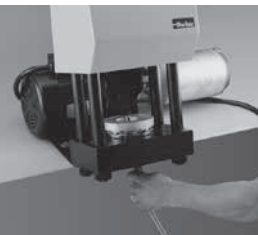

Assemble Hose – Insert hose and fitting from bottom of crimper and up through die set. Position fitting so bottom of fitting skirt rests on die step (PARKALIGN® feature).

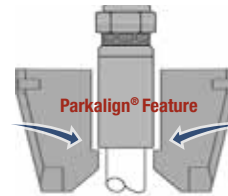

While holding hose and fitting in position on die step, crimp fitting onto hose until die ring contacts base plate.

Note – Pump on crimper must not exceed the rated pressure of the crimper being used. Parker Hannifin will not accept responsibility for the operation of or provide warranty coverage for a crimper that is operated by a power unit other than equipment supplied by Parker Hannifin for the express purpose of operating.

Warning Keep fingers and hands away from die-pusher area. Failure to do so may result in personal injury.

8

Measure & Inspect



Measure and verify hose assembly length.

Inspect insertion depth mark at fitting ends. Insertion mark must be visible but not exceed 1/8" from end of crimped fitting shell.



Measure crimp diameter of each fitting at the top, middle and bottom of the crimp shell. Take measurements at a minimum of three (3) places around the shell circumference.

Crimp acceptance is based on the middle measurement average with a maximum taper of 0.010" between the top and bottom crimp averages. No single measurement outside the specification is permissible.

A Hose

B Tubing

C Coiled Air Hose & Fittings

D Transportation

E Fittings

F Tooling, Equipment & Accessories

G General Technical

Minikrimp Fitting Assembly

Permanent Crimp - Series 56, CG, 92, CY, MS, SF

CAUTION

There are several sections for Hose Assembly and Crimping. **Be sure you are in the section that corresponds to the fitting series you are using.** See Table of Contents for listing.

1

Inspection

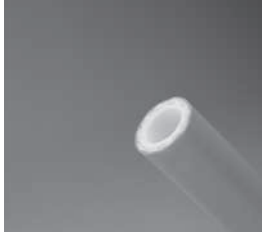

Hose – Visually inspect both ends of hose for square cut. Remove any burrs, loose fibers or wires.



Fittings – Verify fitting series corresponds to the selected hose. Visually inspect fitting(s) for a through-hole, threads and damage.

2

Assembly Prep



Insertion Depth – Mark hose end with proper insertion depth line. Shown is a 56 Series fitting. See Hose Fitting Insertion Values, pg. E-10 for insertion depths of fitting series that do not incorporate an insertion depth.



Lubrication (as required) – Using an SAE 20 weight lubricating oil, lightly lubricate inside of hose end.

Warning Do not use lubricating oil when installing fittings on hose used in breathing air systems.

When installing fittings on hose used in breathing air systems, lubricate with a non-oil based soap solution as failure to do so may result in personal injury.

3

Assembly



Assemble Hose – Push hose into fitting all the way to depth insertion mark.

If fitting does not readily slide onto hose, perform the next step.



Using Parker VBS or VBL (vise blocks) and a rubber mallet, tap fitting onto hose until bottom of fitting shell is aligned with depth insertion mark.

4

Die Selection

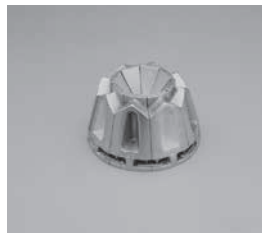

Select proper Parkrimp die set.

Reference Crimp Die Selection at CrimpSource online.

www.parker.com/crimpsource

5

Lubricate Bowl



Remove pusher from shoulder bolt.

Using a premium, quality, lithium-based grease, apply a thin layer of grease on bowl of crimper baseplate.

Minikrimp Fitting Assembly

Permanent Crimp - Series 56, CG, 92, CY, MS, SF

CAUTION

There are several sections for Hose Assembly and Crimping. **Be sure you are in the section that corresponds to the fitting series you are using.** See Table of Contents for listing.

6

Die and Spacer Ring



Crimp Die – Place die set into bowl.

Replace pusher onto shoulder bolt.

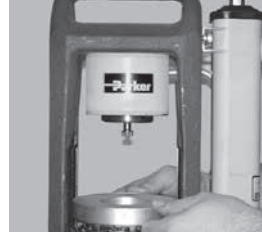

Die Ring – Place applicable die ring on top of crimp die. Position die ring so it is centered on the crimp die. Parflex utilizes the Silver die ring (8XC-R01) with limited exception.

Reference proper tooling (crimp die and die ring) at Crimpsource on-line. www.parker.com/crimpsource

7

Crimp



Assemble Hose – Insert hose and fitting from bottom of crimper and up through die set. Position fitting so bottom of fitting skirt rests on die step (PARKALIGN® feature).

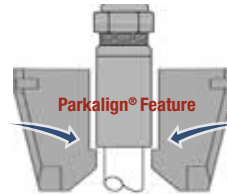

While holding hose and fitting in position on die step, crimp fitting onto hose until die ring contacts base plate.

Note - Pump on crimper must not exceed the rated pressure of the crimper being used. Parker Hannifin will not accept responsibility for the operation of or provide warranty coverage for a crimper that is operated by a power unit other than equipment supplied by Parker Hannifin for the express purpose of operating

Warning Keep fingers and hands away from die-pusher area. Failure to do so may result in personal injury.

8

Measure & Inspect



Measure and verify hose assembly length.

Inspect insertion depth mark at fitting ends. Insertion mark must be visible but not exceed 1/8" from end of crimped fitting shell.



Measure crimp diameter of each fitting at the top, middle and bottom of the crimp shell. Take measurements at a minimum of three (3) places around the shell circumference.

Crimp acceptance is based on the middle measurement average with a maximum taper of 0.010" between the top and bottom crimp averages. No single measurement outside the specification is permissible.

A Hose

B Tubing

C Coiled Air Hose & Fittings

D Transportation

F Fittings

T Tooling, Equipment & Accessories

General Technical

Field Attachable Assembly

Series 51, 51R, BU, MS

CAUTION

There are several sections for Hose Assembly and Crimping. **Be sure you are in the section that corresponds to the fitting series you are using.** See Table of Contents for listing.

1

Inspection

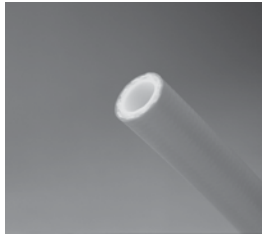

Hose – Visually inspect both ends of hose for square cut. Remove any burrs, loose fibers or wires.



Fittings – Inspect nipple for a through-hole, damaged or missing threads and improperly crimped nut (if applicable). Do not use if these conditions exist. Inspect socket for damaged or missing threads. Do not use if conditions exist.

2

Assembly

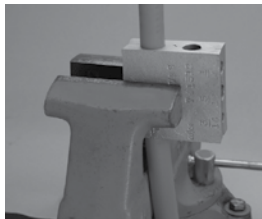

Using the Parker VBS or VBL vise block, place hose in proper hole of the vise block and then clamp in a bench vise. Ensure enough hose extends from the vise block to install socket.

CAUTION Ensure hose is installed in correct size hole of vise block. Clamping hose in a smaller hole will crush hose.

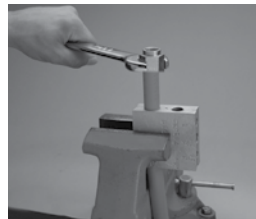

Using a wrench or deep well socket with 51R, screw the socket onto the hose counterclockwise until it bottoms. Ensure end of hose is against inside shoulder. Back off socket 1/4 turn clockwise.

Socket should be firm when tightened but not difficult to install. If socket is difficult to install, apply lubricant that is compatible with the hose material.

The 51R Series Field-attachable fitting features an optional deep-well socket assembly procedure with either ratchet or power drill at low speed allowing for quick, power assist assembly giving you more control on the turn and rate.

Note

- ✓ MS Series - Do not use a lubricant.
- ✓ 51R Series - Lubrication must be used for assembly.

3

Assembly



Place hex portion of socket into vise and tighten vise. Ensure socket extends past vise jaws enough to allow for installation of nipple

CAUTION When tightening socket in vise, do not over tighten vise jaws. Over tightening vise jaws will distort internal threads of socket and hamper installation of nipple.

Using an SAE 20 weight lubricating oil, generously lubricate nipple and socket, threads and hose I.D.



Using using a wrench on the nipple hex, screw nipple into socket clockwise until nipple bottoms against socket shoulder.

CAUTION Nipple should be firm when tightened but not difficult to turn. If nipple is difficult to install, check hose for proper lubrication. Re-apply lubricating oil as necessary. Installation of nipple without proper lubrication will damage core tube.

Note - For 51R-series fittings, the nipple will thread directly into the hose and socket.

4

Measure and Inspect



Measure and verify hose assembly length.

PTFE Assembly

Permanent Crimp - Series 91, 91N, 93N

CAUTION

There are several sections for Hose Assembly and Crimping. **Be sure you are in the section that corresponds to the fitting series you are using.** See Table of Contents for listing.

1

Cut

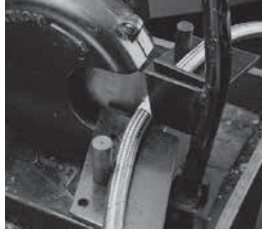

Using a power hose cut-off saw, cut hose squarely.



Fittings – Inspect nipple for a through-hole, damaged or missing threads and improperly crimped nut (if applicable). Do not use if these conditions exist. Inspect socket for damaged or missing threads. Do not use if conditions exist.

Note

✓ 93N Series -Make certain crimp shell is screwed tight to the nipple.



Visually inspect both ends of hose for square cut. Remove any burrs, loose fibers or wires.

2

Assembly

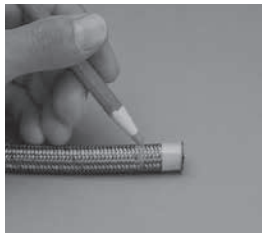

Insertion Depth – Mark hose end with proper insertion depth line. See Hose Fitting Insertion Values, E-10 for insertion depths of fitting series that do not incorporate an insertion depth. For jacketed PTFE hoses, use a sharp knife and light pressure to cut back the cover at least the length of the insertion depth of the fitting.



Assemble Hose – Push fitting onto hose slightly and then remove tape. Continue pushing fitting onto hose until fitting reaches depth insertion mark.

Warning Do not use lubricating oil when installing fittings on hose used in breathing air systems.

When installing fittings on hose used in breathing air systems, lubricate with a non-oil based soap solution as failure to do so may result in personal injury. personal injury when hose is used.

3

Die Selection

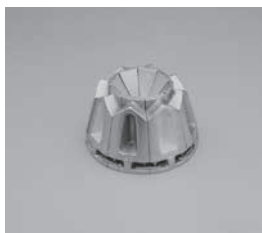

Select proper Parkrimp die set.

Reference Crimp Die Selection at Crimpsource online.

www.parker.com/crimpsource

4

Lubricate Bowl



Using a premium, quality, lithium-based grease. Apply a thin layer of grease on bowl of crimper base plate.

A Hose

B Tubing

C Coiled Air Hose & Fittings

D Transportation

F Fittings

Tooling, Equipment & Accessories

General Technical

PTFE Assembly

Permanent Crimp - Series 91, 91N, 93N

CAUTION

There are several sections for Hose Assembly and Crimping. **Be sure you are in the section that corresponds to the fitting series you are using.** See Table of Contents for listing.

5

Die and Spacer Ring



Crimp Die – Place die set into bowl.

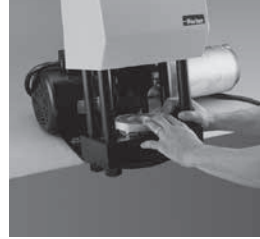

Die Ring – Place applicable die ring on top of crimp die. Position die ring so it is centered on the crimp die. Parflex utilizes the Silver die ring (8XC-R01) with limited exception.

Reference proper tooling (crimp die and die ring) at Crimpsource on-line.

www.parker.com/crimpsource

6

Crimp

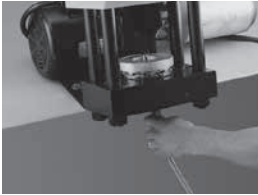

Assemble Hose – Insert hose and fitting from bottom of crimper and up through die set. Position fitting so bottom of fitting skirt rests on die step (PARKALIGN® feature).

Warning Keep fingers and hands away from die-pusher area. Failure to do so may result in personal injur.

Note - Pump on crimper must not exceed the rated pressure of the crimper being used. Parker Hannifin will not accept responsibility for the operation of or provide warranty coverage for a crimper that is operated by a power unit other than equipment supplied by Parker Hannifin for the express purpose of operating .

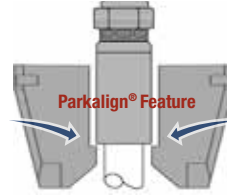

While holding hose and fitting in position on die step, crimp fitting onto hose until die ring contacts base plate.

Note - Pump on crimper must not exceed the rated pressure of the crimper being used. Parker Hannifin will not accept responsibility for the operation of or provide warranty coverage for a crimper that is operated by a power unit other than equipment supplied by Parker Hannifin for the express purpose of operating

Warning Keep fingers and hands away from die-pusher area. Failure to do so may result in personal injury.

7

Measure & Inspect



Measure and verify hose assembly length.

Inspect insertion depth mark at fitting ends. Insertion mark must be visible but not exceed 1/8" from end of crimped fitting shell.



Measure crimp diameter of each fitting at the top, middle and bottom of the crimp shell. Take measurements at a minimum of three (3) places around the shell circumference.

Crimp acceptance is based on the middle measurement average with a maximum taper of 0.010" between the top and bottom crimp averages. No single measurement outside the specification is permissible.

PTFE Assembly

Permanent Crimp - Series PAGE

CAUTION

There are several sections for Hose Assembly and Crimping. **Be sure you are in the section that corresponds to the fitting series you are using.** See Table of Contents for listing.

1

Inspection/Marking

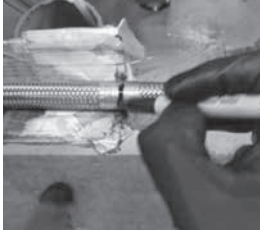

Obtain correct hose, fittings and collars per customer order. Inspect to make certain no defects are present on fittings, collars or hose.

Using 1" wide filament tape, apply 1 to 1½ wraps of tape tightly around hose at location to be cut. Mark tape in the middle where cut will be made. Tape will be left on during crimping so only ½" width of tape should remain.



Fittings – Inspect each component for possible damage. In addition, inspect socket and nipple for a through-hole and threads.

2

Assembly



Cut hose.



Blow ends of hose off / out to remove any debris left from cutting operation. Cut off wires or fabric extending past the end of the hose.

3

Assembly



PAGE series fittings are not one piece but two pieces (insert plus collar) and must be properly installed to assure leak free long life assemblies.



Orient and place collar on hose end fully.

A Hose

B Tubing

C Coiled Air Hose & Fittings

D Transportation

F Fittings

T Tooling, Equipment & Accessories

G General Technical

PTFE Assembly

Permanent Crimp - Series PAGE

CAUTION

There are several sections for Hose Assembly and Crimping. **Be sure you are in the section that corresponds to the fitting series you are using.** See Table of Contents for listing.

4

Assembly

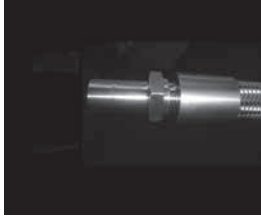

Using a taper punch, push punch into tube to enlarge bore of hose so insert just slides into hose.

Push insert into hose until lock groove of insert is just at end of collar.

Pull collar out towards end of insert until at correct crimp position on insert of collar.

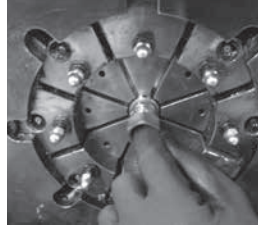

Pull collar out towards end of insert until at Crimp assembly only in Parker Approved adjustable crimper. Select correct die and crimp spec from Parker Crimp Source.

www.parker.com/crimpsource

a. Place assembly into crimp dies so full collar length crimp is obtained.

b. Check crimp dimensions in four places around the middle of the crimp circumference. Verify the average of those readings is within crimp specification tolerances.

Adjust crimper up or down if needed to obtain proper dimension.

c. Crimp opposite end following the same procedures.

Warning Keep fingers and hands away from die-pusher area. Failure to do so may result in personal injury.

5

Inspect

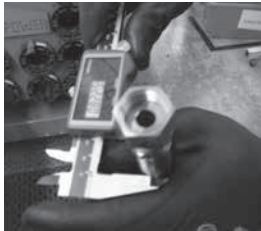

Inspect assembly, noting the length.

Test to correct test pressures to assure no leaks are observed using hydrostatic pressure unit (recommended).

Air or nitrogen under water can be used with caution utilizing the proper pressure and procedures for that equipment.

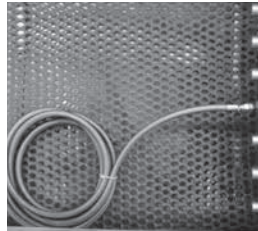

Blow out all water from the assembly and recheck length.

Note

✓ Note any movement of length and make compensations as needed on next assembly.

✓ Package assembly appropriately for customer requirements.

PTFE Assembly

Field Attachable - Series 90

CAUTION

There are several sections for Hose Assembly and Crimping. **Be sure you are in the section that corresponds to the fitting series you are using.** See Table of Contents for listing.

1

Inspection



Hose – Visually inspect both ends of hose for square cut. Remove any burrs, loose fibers or wires.



Fittings – Inspect each component for possible damage.

Inspect socket and nipple for a through-hole and threads.

2

Assembly



Mount nipple hex in vise. Ensure nipple end extends beyond vise jaws sufficiently to allow installation of hose.



Push hose bore onto nipple to size tube and to aid in separating braid before assembling ferrule onto hose.

Once completed, remove hose from nipple.

3

Assembly



By hand, push sleeve over end of PTFE core tube and under wire braid.



To complete positioning of sleeve, push hose end with sleeve against a solid flat surface.

A Hose

B Tubing

C Coiled Air Hose & Fittings

D Transportation

E Fittings

F Tooling, Equipment & Accessories

G General Technical

PTFE Assembly

Field Attachable - Series 90

CAUTION

There are several sections for Hose Assembly and Crimping. **Be sure you are in the section that corresponds to the fitting series you are using.** See Table of Contents for listing.

5

Assembly



Verify tube butts against inside shoulder of ferrule.



Using a tapered punch, push punch into end of sleeve and tube to set sleeve barbs into tube.

6

Assembly



Using SAE 20 weight oil, lubricate nipple and socket threads. For stainless steel fittings use Parker Thread-Mate® or a molybdenum type lubricant.

Warning Do not use lubricating oil when installing fittings on hose use in breathing air systems.

When installing fittings on hose used in breathing air systems, lubricate with a non-oil based soap solution as failure to do so may result in personal injury.

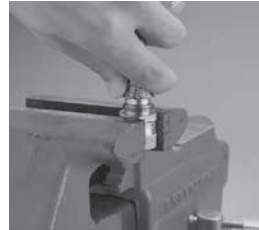

Assemble Hose – Using a twisting motion, push hose over nipple until hose is seated against nipple chamfer.

7

Assembly



Push socket forward and hand-start threading of socket to nipple.

CAUTION When tightening socket in vise, do not over tighten vise jaws. Over tightening vise jaws will distort internal threads of socket.

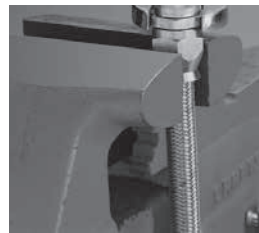

Remove assembly from vise and reposition with socket in vise jaws. Ensure socket extends beyond vise jaws far enough to allow nipple to be completely tightened.

8

Assembly



Wrench tighten nipple hex until clearance between hex and socket hex is 1/32" or less.

Tighten further to align corners of nipple and socket hexes if necessary.

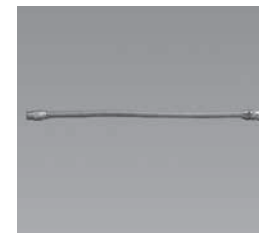

Measure and verify hose assembly length.

Sewer Hose Swaged Assembly

Series SQ

CAUTION

There are several sections for Hose Assembly and Crimping. **Be sure you are in the section that corresponds to the fitting series you are using.** See Table of Contents for listing.

1

Inspection



Hose – Visually inspect both ends of hose for square cut. Remove any burrs, loose fibers or wires.



Fittings – Visually inspect fitting for properly crimped shells, internal barbs, a through-hole and damage.

2

Assembly



Insertion Depth – Mark hose end with proper insertion depth line.



Lubricate – Using an SAE 20 weight oil, lightly lubricate inside of both hose ends.

3

Assembly



Assemble Hose – Push each hose end into fitting to the depth insertion mark.



Remove both die securing bolts and nuts.

4

Assembly



Place hose and fitting assembly into position on swager.

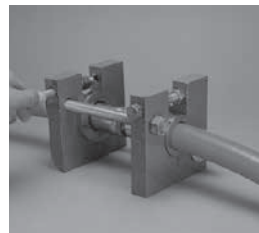

Insert both die halves around hose in each end of swager.

Install both die securing bolts with nuts positioned in opening of swager plates. Tighten die securing bolts 1/4 turn past finger tight.

A Hose

B Tubing

C Coiled Air Hose & Fittings

D Transportation

F Fittings

Tooling, Equipment & Accessories

General Technical

Sewer Hose Swaged Assembly

Series SQ

CAUTION

There are several sections for Hose Assembly and Crimping. **Be sure you are in the section that corresponds to the fitting series you are using.** See Table of Contents for listing.

5

Assembly

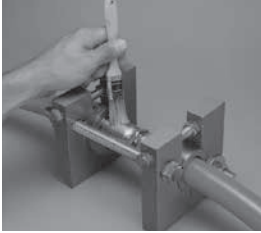

Lubricate – Using SAE 20 oil, generously lubricate the steel fitting surface and ID of the swage dies.

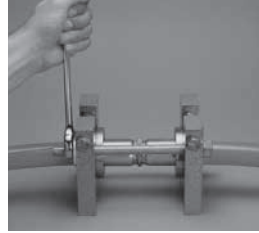

Assemble Hose – Align swager plates in parallel and tighten nuts on swaging bolts uniformly until dies touch.

CAUTION When tightening socket in vise, do not over tighten vise jaws. Over tightening vise jaws will distort internal threads of socket and hamper installation of nipple.

Generously lubricate swaging bolts. Failure to do so may result in an improperly swaged fitting.

6

Assembly

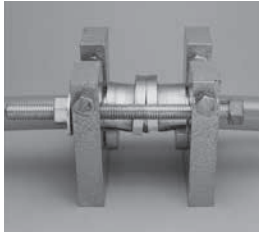

Loosen swaging bolts to release pressure on dies.

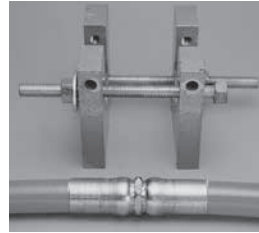

Remove die securing bolts and nuts. Then remove dies.

Push each hose end into fitting to the depth insertion mark.

7

Assembly

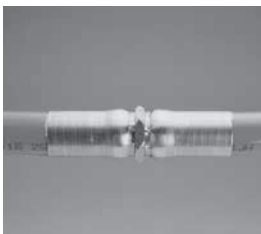

Measure and verify hose assembly length.

Inspect insertion depth mark at fitting ends, which must be visible, but not exceed 1/8" from end of swage shell.

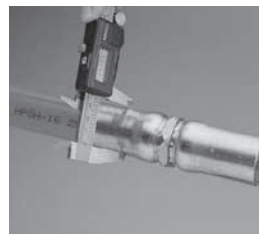

Measure swage diameter of each fitting at top, middle and bottom of shell. Take measurements at a minimum of three places around shell circumference. Verify swage diameter is within tolerances.

Reference Swage Specification & Tool Selection Chart on pg. F-14 for proper swage diameters.

Twin/Multi-Line Separation

Factory-built assemblies are available using twin/multi-line hoses.

When field-built assemblies are preferred, the following steps must be taken.

1

Set-Up

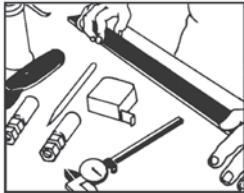

Position twinned or multi-line hose assembly so that it lies flat on work surface without tendency to twist or turn.

2

Measure

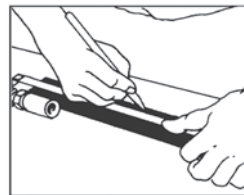

Measure hose to length.

Measure and mark the length that the hoses are to be separated (commonly referred to as Splitback Length).

3

Lubrication

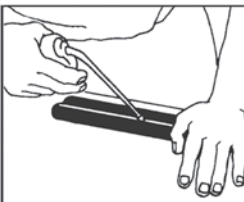

Lightly lubricate the web area between the hoses. Distribute the lubricant uniformly along the web of the assembly to be separated. Any lightweight oil will suffice (SAE 10 or 20). The function of the oil is to reduce the friction of the knife blade so that it naturally seeks the center of the valley formed by the hoses. This eliminates the need for the operator to steer the knife.

4

Cut

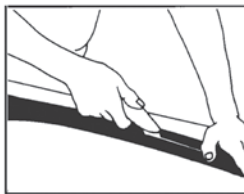

Press the multi-line hose assembly firmly and flat against the work surface with your free hand so that it does not move. Using a sharp utility knife, carefully draw the knife toward you with constant light to moderate pressure, and a smooth stroke. Multiple strokes will be necessary to separate the hoses.

Note - It is important that the knife blade be perpendicular to the hose during this procedure so that the blade cuts only the center line of the web. Extreme care must be taken to avoid cutting through the cover of the hoses and thereby exposing the hose reinforcement. If this occurs, the hose assembly must be discarded (See Figure 1). If the separation length is greater than that which can be accomplished with one continuous, smooth stroke, then the procedure should be repeated over shorter distances always cutting toward the free end of the hoses.

A Hose

B Tubing

C Coiled Air Hose & Fittings

D Transportation

E Fittings

F Tooling, Equipment & Accessories

G General Technical

Twin/Multi-Line Separation

A Hose

B Tubing
Thermoplastic

C Coiled Air Hose
& Fittings

D Transportation

E Fittings

F Tooling,
Equipment
& Accessories

G General
Technical

5

Measure Separation

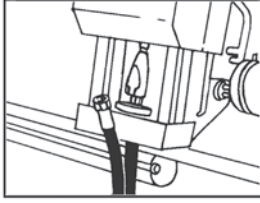

It is suggested that the separation length be sufficiently long so that the crimping operation can be accomplished without risk of kinking the hoses or tearing the web which could result in exposure of the hose reinforcement

6

Apply Tape

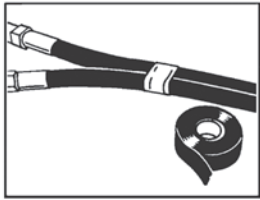

At the option of the assembler, as dictated by the installation, a nylon lashing strap or tape may be applied at the termination of the separated length to provide protection against tearing of the web or hose covers.

Incorrect Handling

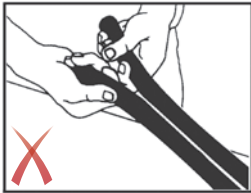

Extreme care must be taken to avoid cutting through the cover of the hoses and thereby exposing the hose reinforcement. If this occurs, the hose assembly must be discarded.

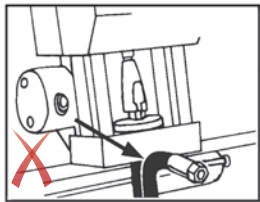

The separation length must allow for the crimping operation without damaging the hose.

Parker Safety Guide

Parker Safety Guide for Selecting and Using Hose, Tubing, Fittings, Connectors, Conductors, Valves and Related Accessories



Parker Safety Guide for Selecting and Using Hose, Tubing, Fittings and Related Accessories

Publication No. 4400-B.1

Revised: October 2015, Rev A

WARNING: Failure or improper selection or improper use of hose, tubing, fittings, assemblies, valves, connectors, conductors or related accessories ("Products") can cause death, personal injury and property damage. Possible consequences of failure or improper selection or improper use of these Products include but are not limited to:

- Fittings thrown off at high speed.
- High velocity fluid discharge.
- Explosion or burning of the conveyed fluid.
- Electrocutation from high voltage electric powerlines.
- Contact with suddenly moving or falling objects that are controlled by the conveyed fluid.
- Injections by high-pressure fluid discharge.

- Dangerously whipping Hose.
- Tube or pipe burst.
- Weld joint fracture.
- Contact with conveyed fluids that may be hot, cold, toxic or otherwise injurious.
- Sparking or explosion caused by static electricity buildup or other sources of electricity.
- Sparking or explosion while spraying paint or flammable liquids.
- Injuries resulting from inhalation, ingestion or exposure to fluids.

Before selecting or using any of these Products, it is important that you read and follow the instructions below. No product from any division in Parker Fluid Connectors Group is approved for in-flight aerospace applications. For hoses and fittings used in in-flight aerospace applications, please contact Parker Aerospace Group.

1.0 GENERAL INSTRUCTIONS

1.1 Scope: This safety guide provides instructions for selecting and using (including assembling, installing, and maintaining) these Products. For convenience, all rubber and/or thermoplastic products commonly called "hose" or "tubing" are called "Hose" in this safety guide. Metallic tube or pipe are called "tube". All assemblies made with Hose are called "Hose Assemblies". All assemblies made with Tube are called "Tube Assemblies".

All products commonly called "fittings", "couplings" or "adapters" are called "Fittings". Valves are fluid system components that control the passage of fluid. Related accessories are ancillary devices that enhance or monitor performance including crimping, flaring, flanging, presetting, bending, cutting, deburring, swaging machines, sensors, tags, lockout handles, spring guards and associated tooling. This safety guide is a supplement to and is to be used with the specific Parker publications for the specific Hose, Fittings and Related Accessories that are being considered for use. Parker publications are available at www.parker.com. SAE J1273 (www.sae.org) and ISO 17165-2 (www.ansi.org) also provide recommended practices for hydraulic Hose Assemblies, and should be followed.

1.2 Fail-Safe: Hose, Hose Assemblies, Tube, Tube Assemblies and Fittings can and do fail without warning for many reasons. Design all systems and equipment in a fail-safe mode, so that failure of the Hose, Hose Assembly, Tube, Tube Assembly or Fitting will not endanger persons or property.

1.3 Distribution: Provide a copy of this safety guide to each person responsible for selecting or using Hose, Tube and Fitting products. Do not select or use Parker Hose, Tube or Fittings without thoroughly reading and understanding this safety guide as well as the specific Parker publications for the Products.

1.4 User Responsibility: Due to the wide variety of operating conditions and applications for Hose, Tube and Fittings. Parker does not represent or warrant that any particular Hose, Tube or Fitting is suitable for any specific end use system. This safety guide does not analyze all technical parameters that must be considered in selecting a product. The user, through its own analysis and testing, is solely responsible for:

- Making the final selection of the Products.
- Assuring that the user's requirements are met and that the application presents no health or safety hazards.
- Following the safety guide for Related Accessories and being trained to operate Related Accessories.
- Providing all appropriate health and safety warnings on the equipment on which the Products are used.
- Assuring compliance with all applicable government and industry standards.

1.5 Additional Questions: Call the appropriate Parker technical service department if you have any questions or require any additional information. See the Parker publication for the Products being considered or used, or call 1-800-CPARKER, or go to www.parker.com, for telephone numbers of the appropriate technical service department.

2.0 HOSE, TUBE & FITTINGS SELECTION INSTRUCTIONS

2.1 Electrical Conductivity: Certain applications require that the Hose be nonconductive to prevent electrical current flow. Other applications require the Hose and the Fittings and the Hose/Fitting interface to be sufficiently conductive to drain off static electricity. Extreme care must be exercised when selecting Hose, Tube and Fittings for these or any other applications in which electrical conductivity or nonconductivity is a factor.

The electrical conductivity or nonconductivity of Hose, Tube and Fittings is dependent upon many factors and may be susceptible to change. These factors include but are not limited to the various materials used to make the Hose and the Fittings, Fitting finish (some Fitting finishes are electrically conductive while others are nonconductive), manufacturing methods (including moisture control), how the Fittings contact the Hose, age and amount of deterioration or damage or other changes, moisture content of the Hose at any particular time, and other factors.

The following are considerations for electrically nonconductive and conductive Hose. For other applications consult the individual catalog pages and the appropriate industry or regulatory standards for proper selection.

2.1.1 Electrically Nonconductive Hose: Certain applications require that the Hose be nonconductive to prevent electrical current flow or to maintain electrical isolation. For applications that require Hose to be electrically nonconductive, including but not limited to applications near high voltage electric lines, only special nonconductive Hose can be used. The manufacturer of the equipment in which the nonconductive Hose is to be used must be consulted to be certain that the Hose, Tube and Fittings that are selected are proper for the application. Do not use any Parker Hose or Fittings for any such application requiring nonconductive Hose, including but not limited to applications near high voltage electric lines or dense magnetic fields, unless (i) the application is expressly approved in the Parker technical publication for the product, (ii) the Hose is marked "nonconductive", and (iii) the manufacturer of the equipment on which the Hose is to be used specifically approves the particular Parker Hose, Tube and Fittings for such use.

2.1.2 Electrically Conductive Hose: Parker manufactures special Hose for certain applications that require electrically conductive Hose. Parker manufactures special Hose for conveying paint in airless paint spraying applications. This Hose is labeled "Electrically Conductive Airless Paint Spray Hose" on its layline and packaging. This Hose must be properly connected to the appropriate Parker Fittings and properly grounded in order to dissipate dangerous static charge buildup, which occurs in all airless paint spraying applications. Do not use any other Hose for airless paint spraying, even if electrically conductive. Use of any other Hose or failure to properly connect the Hose can cause a fire or an explosion resulting in death, personal injury, and property damage. All hoses that convey fuels must be grounded.

Parker manufactures a special Hose for certain compressed natural gas ("CNG") applications where static electricity buildup may occur. Parker CNG Hose assemblies comply with the requirements of ANSI/IAS NGV 4.2; CSA 12.52, "Hoses for Natural Gas Vehicles and Dispensing Systems" (www.ansi.org). This Hose is labeled "Electrically Conductive for CNG Use"

A Hose

B Tubing

C Coiled Air Hose & Fittings

D Transportation

M Fittings

Tooling, Equipment & Accessories

General Technical

Parker Safety Guide pg. 2

on its layline and packaging. This Hose must be properly connected to the appropriate Parker Fittings and properly grounded in order to dissipate dangerous static charge buildup, which occurs in, for example, high velocity CNG dispensing or transfer. Do not use any other Hose for CNG applications where static charge buildup may occur, even if electrically conductive. Use of other Hoses in CNG applications or failure to properly connect or ground this Hose can cause a fire or an explosion resulting in death, personal injury, and property damage. Care must also be taken to protect against CNG permeation through the Hose wall. See section 2.6, Permeation, for more information. Parker CNG Hose is intended for dispenser and vehicle use within the specified temperature range. Parker CNG Hose should not be used in confined spaces or unventilated areas or areas exceeding the specified temperature range. Final assemblies must be tested for leaks. CNG Hose Assemblies should be tested on a monthly basis for conductivity per ANSI/IAS NGV 4.2; CSA 12.52.

Parker manufactures special Hose for aerospace in-flight applications. Aerospace in-flight applications employing Hose to transmit fuel, lubricating fluids and hydraulic fluids require a special Hose with a conductive inner tube. This Hose for in-flight applications is available only from Parker's Stratoflex Products Division. Do not use any other Parker Hose for in-flight applications, even if electrically conductive. Use of other Hoses for in-flight applications or failure to properly connect or ground this Hose can cause a fire or an explosion resulting in death, personal injury and property damage. These Hose assemblies for in-flight applications must meet all applicable aerospace industry, aircraft engine and aircraft requirements .

2.2 Pressure: Hose, Tube and Fitting selection must be made so that the published maximum working pressure of the Hose, Tube and Fittings are equal to or greater than the maximum system pressure. The maximum working pressure of a Hose, or Tube Assembly is the lower of the respective published maximum working pressures of the Hose, Tube and the Fittings used. Surge pressures or peak transient pressures in the system must be below the published maximum working pressure for the Hose, Tube and Fitting. Surge pressures and peak pressures can usually only be determined by sensitive electrical instrumentation that measures and indicates pressures at millisecond intervals. Mechanical pressure gauges indicate only average pressures and cannot be used to determine surge pressures or peak transient pressures. Published burst pressure ratings for Hose is for manufacturing test purposes only and is no indication that the Product can be used in applications at the burst pressure or otherwise above the published maximum recommended working pressure.

2.3 Suction: Hoses used for suction applications must be selected to insure that the Hose will withstand the vacuum and pressure of the system. Improperly selected Hose may collapse in suction application.

2.4 Temperature: Be certain that fluid and ambient temperatures, both steady and transient, do not exceed the limitations of the Hose, Tube, Fitting and Seals. Temperatures below and above the recommended limit can degrade Hose, Tube, Fittings and Seals to a point where a failure may occur and release fluid. Tube and Fittings performances are normally degraded at elevated temperature. Material compatibility can also change at temperatures outside of the rated range. Properly insulate and protect the Hose Assembly when routing near hot objects (e.g. manifolds). Do not use any Hose in any application where failure of the Hose could result in the conveyed fluids (or vapors or mist from the conveyed fluids) contacting any open flame, molten metal, or other potential fire ignition source that could cause burning or explosion of the conveyed fluids or vapors.

2.5 Fluid Compatibility: Hose, and Tube Assembly selection must assure compatibility of the Hose tube, cover, reinforcement, Tube, Plating and Seals with the fluid media used. See the fluid compatibility chart in the Parker publication for the product being considered or used. This information is offered only as a guide. Actual service life can only be determined by the end user by testing under all extreme conditions and other analysis.

Hose, and Tube that is chemically compatible with a particular fluid must be assembled using Fittings and adapters containing likewise compatible seals. Flange or flare processes can change Tube material properties that may not be compatible with certain requirements such as NACE

2.6 Permeation: Permeation (that is, seepage through the Hose or Seal) will occur from inside the Hose or Fitting to outside when Hose or Fitting is used with gases, liquid and gas fuels, and refrigerants (including but not limited to such materials as helium, diesel fuel, gasoline, natural gas, or LPG). This permeation may result in high concentrations of vapors which are potentially flammable, explosive, or toxic, and in loss of fluid. Dangerous explosions, fires, and other hazards can result when using the wrong Hose for such applications. The system designer must take into account the fact that this permeation will take place and

must not use Hose or Fitting if this permeation could be hazardous. The system designer must take into account all legal, government, insurance, or any other special regulations which govern the use of fuels and refrigerants. Never use a Hose or Fitting even though the fluid compatibility is acceptable without considering the potential hazardous effects that can result from permeation through the Hose or Tube Assembly. Permeation of moisture from outside the Hose or Fitting to inside the Hose or Fitting will also occur in Hose or Tube assemblies, regardless of internal pressure. If this moisture permeation would have detrimental effects (particularly, but not limited to refrigeration and air conditioning systems), incorporation of sufficient drying capacity in the system or other appropriate system safeguards should be selected and used. The sudden pressure release of highly pressurized gas could also result in Explosive Decompression failure of permeated Seals and Hoses.

2.7 Size: Transmission of power by means of pressurized fluid varies with pressure and rate of flow. The size of the components must be adequate to keep pressure losses to a minimum and avoid damage due to heat generation or excessive fluid velocity.

2.8 Routing: Attention must be given to optimum routing to minimize inherent problems (kinking or flow restriction due to Hose collapse, twisting of the Hose, proximity to hot objects or heat sources). For additional routing recommendations see SAE J1273 and ISO 17165-2. Hose Assemblies have a finite life and should be installed in a manner that allows for ease of inspection and future replacement. Hose because of its relative short life, should not be used in residential and commercial buildings inside of inaccessible walls or floors, unless specifically allowed in the product literature. Always review all product literature for proper installation and routing instructions.

2.9 Environment: Care must be taken to insure that the Hose, Tube and Fittings are either compatible with or protected from the environment (that is, surrounding conditions) to which they are exposed. Environmental conditions including but not limited to ultraviolet radiation, sunlight, heat, ozone, moisture, water, salt water, chemicals and air pollutants can cause degradation and premature failure.

2.10 Mechanical Loads: External forces can significantly reduce Hose, Tube and Fitting life or cause failure. Mechanical loads which must be considered include excessive flexing, twist, kinking, tensile or side loads, bend radius, and vibration. Use of swivel type Fittings or adapters may be required to insure no twist is put into the Hose. Use of proper Hose or Tube clamps may also be required to reduce external mechanical loads. Unusual applications may require special testing prior to Hose selection.

2.11 Physical Damage: Care must be taken to protect Hose from wear, snagging, kinking, bending smaller than minimum bend radius and cutting, any of which can cause premature Hose failure. Any Hose that has been kinked or bent to a radius smaller than the minimum bend radius, and any Hose that has been cut or is cracked or is otherwise damaged should be removed and discarded. Fittings with damages such as scratches on sealing surfaces and deformation should be replaced.

2.12 Proper End Fitting: See instructions 3.2 through 3.5. These recommendations may be substantiated by testing to industry standards such as SAE J517 for hydraulic applications, or MIL-A-5070, AS1339, or AS3517 for Hoses from Parker's Stratoflex Products Division for aerospace applications.

2.13 Length: When determining the proper Hose or Tube length of an assembly, be aware of Hose length change due to pressure, Tube length change due to thermal expansion or contraction, and Hose or Tube and machine tolerances and movement must be considered. When routing short hose assemblies, it is recommended that the minimum free hose length is always used. Consult the hose manufacturer for their minimum free hose length recommendations. Hose assemblies should be installed in such a way that any motion or flexing occurs within the same plane.

2.14 Specifications and Standards: When selecting Hose, Tube and Fittings, government, industry, and Parker specifications and recommendations must be reviewed and followed as applicable.

2.15 Hose Cleanliness: Hose and Tube components may vary in cleanliness levels. Care must be taken to insure that the Hose and Tube Assembly selected has an adequate level of cleanliness for the application.

2.16 Fire Resistant Fluids: Some fire resistant fluids that are to be conveyed by Hose or Tube require use of the same type of Hose or Tube as used with petroleum base fluids. Some such fluids require a special Hose, Tube, Fitting and Seal, while a few fluids will not work with any Hose at all. See instructions 2.5 and 1.5. The wrong Hose, Tube, Fitting or Seal may fail after a very short service. In addition, all liquids but pure water may burn fiercely under certain conditions, and even pure water leakage may be hazardous.

Hose

Tubing
Thermoplastic

Coiled Air Hose
& Fittings

Transportation

Fittings

Tooling,
Equipment
& Accessories

General
Technical

2.17 Radiant Heat: Hose and Seals can be heated to destruction without contact by such nearby items as hot manifolds or molten metal. The same heat source may then initiate a fire. This can occur despite the presence of cool air around the Hose or Seal. Performance of Tube and Fitting subjected to the heat could be degraded.

2.18 Welding or Brazing: When using a torch or arc welder in close proximity to hydraulic lines, the hydraulic lines should be removed or shielded with appropriate fire resistant materials. Flame or weld spatter could burn through the Hose or Seal and possibly ignite escaping fluid resulting in a catastrophic failure. Heating of plated parts, including Hose Fittings and adapters, above 450°F (232°C) such as during welding, brazing or soldering may emit deadly gases. Any elastomer seal on fittings shall be removed prior to welding or brazing, any metallic surfaces shall be protected after brazing or welding when necessary. Welding and brazing filler material shall be compatible with the Tube and Fitting that are joined.

2.19 Atomic Radiation: Atomic radiation affects all materials used in Hose and Tube assemblies. Since the long-term effects may be unknown, do not expose Hose or Tube assemblies to atomic radiation. Nuclear applications may require special Tube and Fittings.

2.20 Aerospace Applications: The only Hose, Tube and Fittings that may be used for in-flight aerospace applications are those available from Parker's Stratoflex Products Division. Do not use any other Hose or Fittings for in-flight applications. Do not use any Hose or Fittings from Parker's Stratoflex Products Division with any other Hose or Fittings, unless expressly approved in writing by the engineering manager or chief engineer of Stratoflex Products Division and verified by the user's own testing and inspection to aerospace industry standards.

2.21 Unlocking Couplings: Ball locking couplings or other Fittings with quick disconnect ability can unintentionally disconnect if they are dragged over obstructions, or if the sleeve or other disconnect member, is bumped or moved enough to cause disconnect. Threaded Fittings should be considered where there is a potential for accidental uncoupling.

3.0 HOSE AND FITTINGS ASSEMBLY AND INSTALLATION INSTRUCTIONS

3.1 Component Inspection: Prior to assembly, a careful examination of the Hose and Fittings must be performed. All components must be checked for correct style, size, catalog number, and length. The Hose must be examined for cleanliness, obstructions, blisters, cover looseness, kinks, cracks, cuts or any other visible defects. Inspect the Fitting and sealing surfaces for burrs, nicks, corrosion or other imperfections. Do NOT use any component that displays any signs of nonconformance.

3.2 Hose and Fitting Assembly: Do not assemble a Parker Fitting on a Parker Hose that is not specifically listed by Parker for that Fitting, unless authorized in writing by the engineering manager or chief engineer of the appropriate Parker division. Do not assemble a Parker Fitting on another manufacturer's Hose or a Parker Hose on another manufacturer's Fitting unless (i) the engineering manager or chief engineer of the appropriate Parker division approves the Assembly in writing or that combination is expressly approved in the appropriate Parker literature for the specific Parker product, and (ii) the user verifies the Assembly and the application through analysis and testing. For Parker Hose that does not specify a Parker Fitting, the user is solely responsible for the selection of the proper Fitting and Hose Assembly procedures. See instruction 1.4.

To prevent the possibility of problems such as leakage at the Fitting or system contamination, it is important to completely remove all debris from the cutting operation before installation of the Fittings. The Parker published instructions must be followed for assembling the Fittings on the Hose. These instructions are provided in the Parker Fitting catalog for the specific Parker Fitting being used, or by calling 1-800-CPARKER, or at www.parker.com.

3.3 Related Accessories: Do not crimp or swage any Parker Hose or Fitting with anything but the listed swage or crimp machine and dies in accordance with Parker published instructions. Do not crimp or swage another manufacturer's Fitting with a Parker crimp or swage die unless authorized in writing by the engineering manager or chief engineer of the appropriate Parker division.

3.4 Parts: Do not use any Parker Fitting part (including but not limited to socket, shell, nipple, or insert) except with the correct Parker mating parts, in accordance with Parker published instructions, unless authorized in writing by the engineering manager or chief engineer of the appropriate Parker division.

3.5 Field Attachable/Permanent: Do not reuse any field attachable Hose Fitting that has blown or pulled off a Hose. Do not reuse a Parker permanent Hose Fitting (crimped or swaged) or any part thereof. Complete

Hose Assemblies may only be reused after proper inspection under section 4.0. Do not assemble Fittings to any previously used hydraulic Hose that was in service, for use in a fluid power application.

3.6 Pre-Installation Inspection: Prior to installation, a careful examination of the Hose Assembly must be performed. Inspect the Hose Assembly for any damage or defects. DO NOT use any Hose Assembly that displays any signs of nonconformance.

3.7 Minimum Bend Radius: Installation of a Hose at less than the minimum listed bend radius may significantly reduce the Hose life. Particular attention must be given to preclude sharp bending at the Hose to Fitting juncture. Any bending during installation at less than the minimum bend radius must be avoided. If any Hose is kinked during installation, the Hose must be discarded.

3.8 Twist Angle and Orientation: Hose Assembly installation must be such that relative motion of machine components does not produce twisting.

3.9 Securement: In many applications, it may be necessary to restrain, protect, or guide the Hose to protect it from damage by unnecessary flexing, pressure surges, and contact with other mechanical components. Care must be taken to insure such restraints do not introduce additional stress or wear points.

3.10 Proper Connection of Ports: Proper physical installation of the Hose Assembly requires a correctly installed port connection insuring that no twist or torque is transferred to the Hose when the Fittings are being tightened or otherwise during use.

3.11 External Damage: Proper installation is not complete without insuring that tensile loads, side loads, kinking, flattening, potential abrasion, thread damage or damage to sealing surfaces are corrected or eliminated. See instruction 2.10.

3.12 System Checkout: All air entrapment must be eliminated and the system pressurized to the maximum system pressure (at or below the Hose maximum working pressure) and checked for proper function and freedom from leaks. Personnel must stay out of potential hazardous areas while testing and using.

3.13 Routing: The Hose Assembly should be routed in such a manner so if a failure does occur, the escaping media will not cause personal injury or property damage. In addition, if fluid media comes in contact with hot surfaces, open flame or sparks, a fire or explosion may occur. See section 2.4.

3.14 Ground Fault Equipment Protection Devices (GFEPDs): WARNING! Fire and Shock Hazard. To minimize the danger of fire if the heating cable of a Multitube bundle is damaged or improperly installed, use a Ground Fault Equipment Protection Device. Electrical fault currents may be insufficient to trip a conventional circuit breaker.

For ground fault protection, the IEEE 515: (www.ansi.org) standard for heating cables recommends the use of GFEPDs with a nominal 30 milliamperere trip level for "piping systems in classified areas, those areas requiring a high degree of maintenance, or which may be exposed to physical abuse or corrosive atmospheres".

4.0 TUBE AND FITTINGS ASSEMBLY AND INSTALLATION INSTRUCTIONS

4.1 Component Inspection: Prior to assembly, a careful examination of the Tube and Fittings must be performed. All components must be checked for correct style, size, material, seal, and length. Inspect the Fitting and sealing surfaces for burrs, nicks, corrosion, missing seal or other imperfections. Do NOT use any component that displays any signs of nonconformance.

4.2 Tube and Fitting Assembly: Do not assemble a Parker Fitting with a Tube that is not specifically listed by Parker for that Fitting, unless authorized in writing by the engineering manager or chief engineer of the appropriate Parker division. The Tube must meet the requirements specified to the Fitting. The Parker published instructions must be followed for assembling the Fittings to a Tube. These instructions are provided in the Parker Fitting catalog for the specific Parker Fitting being used, or by calling 1-800-CPARKER, or at www.parker.com.

4.3 Related Accessories: Do not preset or flange Parker Fitting components using another manufacturer's equipment or procedures unless authorized in writing by the engineering manager or chief engineer of the appropriate Parker division. Tube, Fitting component and tooling must be check for correct style, size and material. Operation and maintenance of Related Accessories must be in accordance with the operation manual for the designated Accessory.

4.4 Securement: In many applications, it may be necessary to restrain, protect, or guide the Tube to protect it from damage by unnecessary flexing, pressure surges, vibration, and contact with other mechanical components. Care must be taken to insure such restraints do not introduce additional stress or wear points.

A Hose

B Tubing

C Coiled Air Hose & Fittings

D Transportation

E Fittings

F Tooling, Equipment & Accessories

G General Technical

Parker Safety Guide pg. 4

4.5 Proper Connection of Ports: Proper physical installation of the Tube Assembly requires a correctly installed port connection insuring that no torque is transferred to the Tube when the Fittings are being tightened or otherwise during use.

4.6 External Damage: Proper installation is not complete without insuring that tensile loads, side loads, flattening, potential abrasion, thread damage or damage to sealing surfaces are corrected or eliminated. See instruction 2.10.

4.7 System Checkout: All air entrapment must be eliminated and the system pressurized to the maximum system pressure (at or below the Tube Assembly maximum working pressure) and checked for proper function and freedom from leaks. Personnel must stay out of potential hazardous areas while testing and using.

4.8 Routing: The Tube Assembly should be routed in such a manner so if a failure does occur, the escaping media will not cause personal injury or property damage. In addition, if fluid media comes in contact with hot surfaces, open flame or sparks, a fire or explosion may occur. See section 2.4.

5.0 HOSE AND FITTING MAINTENANCE AND REPLACEMENT INSTRUCTIONS

5.1 Even with proper selection and installation, Hose life may be significantly reduced without a continuing maintenance program. The severity of the application, risk potential from a possible Hose failure, and experience with any Hose failures in the application or in similar applications should determine the frequency of the inspection and the replacement for the Products so that Products are replaced before any failure occurs. Certain products require maintenance and inspection per industry requirements. Failure to adhere to these requirements may lead to premature failure. A maintenance program must be established and followed by the user and, at minimum, must include instructions 5.2 through 5.7

5.2 Visual Inspection Hose/Fitting: Any of the following conditions require immediate shut down and replacement of the Hose Assembly:

- Fitting slippage on Hose;
- Damaged, cracked, cut or abraded cover (any reinforcement exposed);
- Hard, stiff, heat cracked, or charred Hose;
- Cracked, damaged, or badly corroded Fittings;
- Leaks at Fitting or in Hose;
- Kinked, crushed, flattened or twisted Hose; and
- Blistered, soft, degraded, or loose cover.

5.3 Visual Inspection All Other: The following items must be tightened, repaired, corrected or replaced as required:

- Leaking port conditions;
- Excess dirt buildup;/
- Worn clamps, guards or shields; and
- System fluid level, fluid type, and any air entrapment.

5.4 Functional Test: Operate the system at maximum operating pressure and check for possible malfunctions and leaks. Personnel must avoid potential hazardous areas while testing and using the system. See section 2.2.

5.5 Replacement Intervals: Hose assemblies and elastomeric seals used on Hose Fittings and adapters will eventually age, harden, wear and deteriorate under thermal cycling and compression set. Hose Assemblies and elastomeric seals should be inspected and replaced at specific replacement intervals, based on previous service life, government or industry recommendations, or when failures could result in unacceptable downtime, damage, or injury risk. See section 1.2. Hose and Fittings may be subjected to internal mechanical and/or chemical wear from the conveying fluid and may fail without warning. The user must determine the product life under such circumstances by testing. Also see section 2.5.

5.6 Hose Inspection and Failure: Hydraulic power is accomplished by utilizing high pressure fluids to transfer energy and do work. Hoses, Fittings and Hose Assemblies all contribute to this by transmitting fluids at high pressures. Fluids under pressure can be dangerous and potentially lethal and, therefore, extreme caution must be exercised when

working with fluids under pressure and handling the Hoses transporting the fluids. From time to time, Hose Assemblies will fail if they are not replaced at proper time intervals. Usually these failures are the result of some form of misapplication, abuse, wear or failure to perform proper maintenance. When Hoses fail, generally the high pressure fluids inside escape in a stream which may or may not be visible to the user. Under no circumstances should the user attempt to locate the leak by "feeling" with their hands or any other part of their body. High pressure fluids can and will penetrate the skin and cause severe tissue damage and possibly loss of limb. Even seemingly minor hydraulic fluid injection injuries must be treated immediately by a physician with knowledge of the tissue damaging properties of hydraulic fluid.

If a Hose failure occurs, immediately shut down the equipment and leave the area until pressure has been completely released from the Hose Assembly. Simply shutting down the hydraulic pump may or may not eliminate the pressure in the Hose Assembly. Many times check valves, etc., are employed in a system and can cause pressure to remain in a Hose Assembly even when pumps or equipment are not operating. Tiny holes in the Hose, commonly known as pinholes, can eject small, dangerously powerful but hard to see streams of hydraulic fluid. It may take several minutes or even hours for the pressure to be relieved so that the Hose Assembly may be examined safely.

Once the pressure has been reduced to zero, the Hose Assembly may be taken off the equipment and examined. It must always be replaced if a failure has occurred. Never attempt to patch or repair a Hose Assembly that has failed. Consult the nearest Parker distributor or the appropriate Parker division for Hose Assembly replacement information. . Never touch or examine a failed Hose Assembly unless it is obvious that the Hose no longer contains fluid under pressure. The high pressure fluid is extremely dangerous and can cause serious and potentially fatal injury.

5.7 Elastomeric seals: Elastomeric seals will eventually age, harden, wear and deteriorate under thermal cycling and compression set. Elastomeric seals should be inspected and replaced.

5.8 Refrigerant gases: Special care should be taken when working with refrigeration systems. Sudden escape of refrigerant gases can cause blindness if the escaping gases contact the eye and can cause freezing or other severe injuries if it contacts any other portion of the body.

5.9 Compressed natural gas (CNG): Parker CNG Hose Assemblies should be tested after installation and before use, and at least on a monthly basis per instructions provided on the Hose Assembly tag. The recommended procedure is to pressurize the Hose and check for leaks and to visually inspect the Hose for damage and to perform an electrical resistance test.

Caution: Matches, candles, open flame or other sources of ignition shall not be used for Hose inspection. Leak check solutions should be rinsed off after use.

6.0 HOSE STORAGE

6.1 Age Control: Hose and Hose Assemblies must be stored in a manner that facilitates age control and first-in and first-out usage based on manufacturing date of the Hose and Hose Assemblies. Unless otherwise specified by the manufacturer or defined by local laws and regulations:

6.1.1 The shelf life of rubber hose in bulk form or hose made from two or more materials is 28 quarters (7 years) from the date of manufacture, with an extension of 12 quarters (3 years), if stored in accordance with ISO 2230;

6.1.2 The shelf life of thermoplastic and polytetrafluoroethylene hose is considered to be unlimited;

6.1.3 Hose assemblies that pass visual inspection and proof test shall not be stored for longer than 2 years.

6.1.4 Storage: Stored Hose and Hose Assemblies must not be subjected to damage that could reduce their expected service life and must be placed in a cool, dark and dry area with the ends capped. Stored Hose and Hose Assemblies must not be exposed to temperature extremes, ozone, oils, corrosive liquids or fumes, solvents, high humidity, rodents, insects, ultraviolet light, electromagnetic fields or radioactive materials.

A Hose

B Tubing
Thermoplastic

C Coiled Air Hose
& Fittings

D Transportation

E Fittings

F Tooling,
Equipment
& Accessories

G General
Technical

ENERPAC Warranty Policy

For those ENERPAC items sold as part of the Parker Parflex Division product offering, the following warranty applies.

ENERPAC products are warranted to be free of defects in materials and workmanship under normal use for as long as they are owned by the original purchaser, subject to the exclusions and limitations described below. This warranty does not cover ordinary wear and tear, overloading, alterations, (including repairs or attempted repairs by parties other than ENERPAC or its authorized service representatives), improper fluid, use in a manner for which they are not intended or use which is contrary to instructions for the products.

THIS WARRANTY IS LIMITED TO NEW PRODUCTS SOLD THROUGH ENERPAC AUTHORIZED DISTRIBUTORS, ORIGINAL EQUIPMENT MANUFACTURERS OR OTHER DESIGNATED CHANNELS OF DISTRIBUTION. NO AGENT, EMPLOYEE, OR OTHER REPRESENTATIVE OF ENERPAC HAS THE AUTHORITY TO IN ANY WAY CHANGE OR AMEND THIS WARRANTY.

Electronic products and components are warranted against defects in material and workmanship for a period of two years from the date of purchase.

The following items supplied with ENERPAC products are excluded from this warranty:

Components not manufactured by ENERPAC, including air motors, electric motors, gasoline engines, and diesel engines. Such items are warranted to the extent of the warranty provided by the manufacturers of such items.

If the customer believes a product is defective, the product must be delivered, or shipped freight prepaid, to the nearest ENERPAC Authorized Service Center. The customer should contact ENERPAC to locate and Authorized Service Center in the customer's area.

Products that do not conform to this warranty will be returned by ground transportation, freight prepaid.

THE FOREGOING WARRANT IS EXCLUSIVE AND IS IN LIEU OF ALL OTHER EXPRESS AND IMPLIED WARRANTIES, INCLUDING BUT NOT LIMITED TO THE IMPLIED WARRANTIES OF MERCHANTABILITY AND FITNESS FOR A PARTICULAR PURPOSE.

The remedy of repair, replacement or refund is customer's exclusive remedy in the event of breach of this warranty.

SELLER SHALL NOT BE SUBJECT TO AND DISCLAIMS:

- (a) ANY OTHER OBLIGATIONS OR LIABILITIES ARISING OUT OF BREACH OF CONTRACT OR OF WARRANTY,
- (b) ANY OBLIGATIONS WHATSOEVER ARISING FROM TORT CLAIMS (INCLUDING NEGLIGENCE AND STRICT LIABILITY) OR ARISING UNDER THEORIES OR LAW WITH RESPECT TO PRODUCTS SOLD OR SERVICES RENDERED BY SELLER OR ANY UNDERTAKINGS, ACTS OR OMISSIONS RELATING THERETO, AND
- (c) ALL CONSEQUENTIAL, INCIDENTAL AND CONTINGENT DAMAGES WHATSOEVER.

ENERPAC's liability in all cases is limited to, and shall not exceed, the purchase price paid.

For the nearest authorized ENERPAC SERVICE CENTER, please call ENERPAC at 1-800-558-0530 or visit the ENERPAC web site at www.Enerpac.com.

A Hose

B Tubing

C Coiled Air Hose & Fittings

D Transportation

E Fittings

F Tooling, Equipment & Accessories

G General Technical

Offer of Sale

PARKER-HANNIFIN CORPORATION OFFER OF SALE

1. **Definitions.** As used herein, the following terms have the meanings indicated.

Buyer:	means any customer receiving a Quote for Products from Seller.
Goods:	means any tangible part, system or component to be supplied by the Seller.
Products:	means the Goods, Services and/or Software as described in a Quote provided by the Seller.
Quote:	means the offer or proposal made by Seller to Buyer for the supply of Products.
Seller:	means Parker-Hannifin Corporation, including all divisions and businesses thereof.
Services:	means any services to be supplied by the Seller.
Software:	means any software related to the Products, whether embedded or separately downloaded.
Terms:	means the terms and conditions of this Offer of Sale or any newer version of the same as published by Seller electronically at www.parker.com/saleterms .

2. **Terms.** All sales of Products by Seller are contingent upon, and will be governed by, these Terms and, these Terms are incorporated into any Quote provided by Seller to any Buyer. Buyer's order for any Products whether communicated to Seller verbally, in writing, by electronic data interface or other electronic commerce, shall constitute acceptance of these Terms. Seller objects to any contrary or additional terms or conditions of Buyer. Reference in Seller's order acknowledgement to Buyer's purchase order or purchase order number shall in no way constitute an acceptance of any of Buyer's terms of purchase. No modification to these Terms will be binding on Seller unless agreed to in writing and signed by an authorized representative of Seller.

3. **Price; Payment.** The Products set forth in Seller's Quote are offered for sale at the prices indicated in Seller's Quote. Unless otherwise specifically stated in Seller's Quote, prices are valid for thirty (30) days and do not include any sales, use, or other taxes or duties. Seller reserves the right to modify prices at any time to adjust for any raw material price fluctuations. Unless otherwise specified by Seller, all prices are F.C.A. Seller's facility (INCOTERMS 2010). All sales are contingent upon credit approval and payment for all purchases is due thirty (30) days from the date of invoice (or such date as may be specified in the Quote). Unpaid invoices beyond the specified payment date incur interest at the rate of 1.5% per month or the maximum allowable rate under applicable law.

4. **Shipment; Delivery; Title and Risk of Loss.** All delivery dates are approximate. Seller is not responsible for damages resulting from any delay. Regardless of the manner of shipment, delivery occurs and title and risk of loss or damage pass to Buyer, upon placement of the Products with the shipment carrier at Seller's facility. Unless otherwise agreed, Seller may exercise its judgment in choosing the carrier and means of delivery. No deferment of shipment at Buyers' request beyond the respective indicated shipping date will be made except on terms that will indemnify, defend and hold Seller harmless against all loss and additional expense. Buyer shall be responsible for any additional shipping charges incurred by Seller due to Buyer's acts or omissions.

5. **Warranty.** The warranty related to the Products is as follows: (i) Goods are warranted against defects in material or workmanship for a period of twelve (12) months from the date of delivery or 2,000 hours of use, whichever occurs first; (ii) Services shall be performed in accordance with generally accepted practices and using the degree of care and skill that is ordinarily exercised and customary in the field to which the Services pertain and are warranted for a period of six (6) months from the completion of the Services by Seller; and (iii) Software is only warranted to perform in accordance with applicable specifications provided by Seller to Buyer for ninety (90) days from the date of delivery or, when downloaded by a Buyer or end-user, from the date of the initial download. All prices are based upon the exclusive limited warranty stated above, and upon the following disclaimer:

DISCLAIMER OF WARRANTY: THIS WARRANTY IS THE SOLE AND ENTIRE WARRANTY PERTAINING TO PRODUCTS. SELLER DISCLAIMS ALL OTHER WARRANTIES, EXPRESS AND IMPLIED, INCLUDING DESIGN, NONINFRINGEMENT, MERCHANTABILITY, AND FITNESS FOR A PARTICULAR PURPOSE. SELLER DOES NOT WARRANT THAT

THE SOFTWARE IS ERROR-FREE OR FAULT-TOLERANT, OR THAT BUYER'S USE THEREOF WILL BE SECURE OR UNINTERRUPTED. BUYER AGREES AND ACKNOWLEDGES THAT UNLESS OTHERWISE AUTHORIZED IN WRITING BY SELLER THE SOFTWARE SHALL NOT BE USED IN CONNECTION WITH HAZARDOUS OR HIGH RISK ACTIVITIES OR ENVIRONMENTS. EXCEPT AS EXPRESSLY STATED HEREIN, ALL PRODUCTS ARE PROVIDED "AS IS".

6. **Claims; Commencement of Actions.** Buyer shall promptly inspect all Products upon receipt. No claims for shortages will be allowed unless reported to the Seller within ten (10) days of delivery. Buyer shall notify Seller of any alleged breach of warranty within thirty (30) days after the date the non-conformance is or should have been discovered by Buyer. Any claim or action against Seller based upon breach of contract or any other theory, including tort, negligence, or otherwise must be commenced within twelve (12) months from the date of the alleged breach or other alleged event, without regard to the date of discovery.
7. **LIMITATION OF LIABILITY.** IN THE EVENT OF A BREACH OF WARRANTY, SELLER WILL, AT ITS OPTION, REPAIR OR REPLACE THE NON-CONFORMING PRODUCT, RE-PERFORM THE SERVICES, OR REFUND THE PURCHASE PRICE PAID WITHIN A REASONABLE PERIOD OF TIME. **IN NO EVENT IS SELLER LIABLE FOR ANY SPECIAL, INDIRECT, INCIDENTAL OR CONSEQUENTIAL DAMAGES ARISING OUT OF, OR AS THE RESULT OF, THE SALE, DELIVERY, NON- DELIVERY, SERVICING, NON-COMPLETION OF SERVICES, USE, LOSS OF USE OF, OR INABILITY TO USE THE PRODUCTS OR ANY PART THEREOF, LOSS OF DATA, IDENTITY, PRIVACY, OR CONFIDENTIALITY, OR FOR ANY CHARGES OR EXPENSES OF ANY NATURE INCURRED WITHOUT SELLER'S WRITTEN CONSENT, WHETHER BASED IN CONTRACT, TORT OR OTHER LEGAL THEORY. IN NO EVENT SHALL SELLER'S LIABILITY UNDER ANY CLAIM MADE BY BUYER EXCEED THE PURCHASE PRICE PAID FOR THE PRODUCTS.**

8. **Loss to Buyer's Property.** Any designs, tools, patterns, materials, drawings, confidential information or equipment furnished by Buyer or any other items which are or become Buyer's property, will be considered obsolete and may be destroyed by Seller after two (2) consecutive years have elapsed without Buyer ordering the Products manufactured using such property. Seller shall not be responsible for any loss or damage to such property while it is in Seller's possession or control.

9. **Special Tooling.** Special Tooling includes but is not limited to tooling, jigs, fixtures and associated manufacturing equipment acquired or necessary to manufacture Products. A tooling charge may be imposed for any Special Tooling. Such Special Tooling shall be and remain Seller's property notwithstanding payment of any charges by Buyer. In no event will Buyer acquire any interest in Special Tooling belonging to Seller that is utilized in the manufacture of the Products, even if such Special Tooling has been specially converted or adapted for such manufacture and notwithstanding any charges paid by Buyer. Unless otherwise agreed, Seller has the right to alter, discard or otherwise dispose of any Special Tooling or other property in its sole discretion at any time.

10. **Security Interest.** To secure payment of all sums due, Seller retains a security interest in all Products delivered to Buyer and, Buyer's acceptance of these Terms is deemed to be a Security Agreement under the Uniform Commercial Code. Buyer authorizes Seller as its attorney to execute and file on Buyer's behalf all documents Seller deems necessary to perfect its security interest.

11. **User Responsibility.** The Buyer through its own analysis and testing, is solely responsible for making the final selection of the Products and assuring that all performance, endurance, maintenance, safety and warning requirements of the application of the Products are met. The Buyer must analyze all aspects of the application and follow applicable industry standards, specifications, and other technical information provided with the Product. If Seller provides Product options based upon data or specifications provided by the Buyer, the Buyer is responsible for determining that such data and specifications are suitable and sufficient for all applications and reasonably foreseeable uses of the Products. In the event the Buyer is not the end-user, Buyer will ensure such end-user complies with this paragraph.

12. **Use of Products, Indemnity by Buyer.** Buyer shall comply with all instructions, guides and specifications provided by Seller with the Products. Unauthorized Uses. If Buyer uses or resells the Products for any uses prohibited in Seller's instructions, guides or specifications, or Buyer otherwise fails to comply with Seller's instructions, guides and

Continued on next page

specifications, Buyer acknowledges that any such use, resale, or non-compliance is at Buyer's sole risk. Buyer shall indemnify, defend, and hold Seller harmless from any losses, claims, liabilities, damages, lawsuits, judgments and costs (including attorney fees and defense costs), whether for personal injury, property damage, intellectual property infringement or any other claim, brought by or incurred by Buyer, Buyer's employees, or any other person, arising out of: (a) improper selection, application, design, specification or other misuse of Products provided by Seller; (b) any act or omission, negligent or otherwise, of Buyer; (c) Seller's use of patterns, tooling, equipment, plans, drawings, designs or specifications or other information or things furnished by Buyer; (d) damage to the Products from an external cause, repair or attempted repair by anyone other than Seller, failure to follow instructions, guides and specifications provided by Seller, use with goods not provided by Seller, or opening, modifying, deconstructing or tampering with the Products for any reason; or (e) Buyer's failure to comply with these Terms. Seller shall not indemnify Buyer under any circumstance except as otherwise provided in these Terms.

- 13. **Cancellations and Changes** Buyer may not cancel or modify any order for any reason, except with Seller's written consent and upon terms that will indemnify, defend and hold Seller harmless against all direct, incidental and consequential loss or damage. Seller, at any time, may change Product features, specifications, designs and availability.
- 14. **Limitation on Assignment** Buyer may not assign its rights or obligations without the prior written consent of Seller.
- 15. **Force Majeure** Seller does not assume the risk and is not liable for delay or failure to perform any of Seller's obligations by reason of events or circumstances beyond its reasonable control ("Events of Force Majeure"). Events of Force Majeure shall include without limitation: accidents, strikes or labor disputes, acts of any government or government agency, acts of nature, delays or failures in delivery from carriers or suppliers, shortages of materials, or any other cause beyond Seller's reasonable control.
- 16. **Waiver and Severability** Failure to enforce any provision of these Terms will not invalidate that provision; nor will any such failure prejudice Seller's right to enforce that provision in the future. Invalidation of any provision of these Terms by legislation or other rule of law shall not invalidate any other provision herein and, the remaining provisions will remain in full force and effect.
- 17. **Termination** Seller may terminate any agreement governed by or arising from these Terms for any reason and at any time by giving Buyer thirty (30) days prior written notice. Seller may immediately terminate, in writing, if Buyer: (a) breaches any provision of these Terms (b) appoints a trustee, receiver or custodian for all or any part of Buyer's property (c) files a petition for relief in bankruptcy on its own behalf, or one if filed by a third party (d) makes an assignment for the benefit of creditors; or (e) dissolves its business or liquidates all or a majority of its assets.
- 18. **Ownership of Software** Seller retains ownership of all Software supplied to Buyer hereunder. In no event shall Buyer obtain any greater right in and to the Software than a right in the nature of a license limited to the use thereof and subject to compliance with any other terms provided with the Software.
- 19. **Indemnity for Infringement of Intellectual Property Rights** Seller is not liable for infringement of any patents, trademarks, copyrights, trade dress, trade secrets or similar rights ("Intellectual Property Rights") except as provided in this Section. Seller will defend at its expense and will pay the cost of any settlement or damages awarded in an action brought against Buyer based on a third party claim that one or more of the Products sold hereunder infringes the Intellectual Property Rights of a third party in the country of delivery of the Products by the Seller to the Buyer. Seller's obligation to defend and indemnify Buyer is contingent on Buyer notifying Seller within ten (10) days after Buyer becomes aware of any such claim, and Seller having sole control over the defense of the claim including all negotiations for settlement or compromise. If one or more Products sold hereunder is subject to such a claim, Seller may, at its sole expense and option, procure for Buyer the right to continue using the Products, replace or modify the Products so as to render them non-infringing, or offer to

accept return of the Products and refund the purchase price less a reasonable allowance for depreciation. Seller has no obligation or liability for any claim of infringement: (i) arising from information provided by Buyer; or (ii) directed to any Products provided hereunder for which the designs are specified in whole or part by Buyer; or (iii) resulting from the modification, combination or use in a system of any Products provided hereunder. The foregoing provisions of this Section constitute Seller's sole and exclusive liability and Buyer's sole and exclusive remedy for such claims of infringement of Intellectual Property Rights.

- 20. **Governing Law** These Terms and the sale and delivery of all Products are deemed to have taken place in, and shall be governed and construed in accordance with, the laws of the State of Ohio, as applicable to contracts executed and wholly performed therein and without regard to conflicts of laws principles. Buyer irrevocably agrees and consents to the exclusive jurisdiction and venue of the courts of Cuyahoga County, Ohio with respect to any dispute, controversy or claim arising out of or relating to the sale and delivery of the Products.
- 21. **Entire Agreement** These Terms, along with the terms set forth in the main body of any Quote, forms the entire agreement between the Buyer and Seller and constitutes the final, complete and exclusive expression of the terms of sale. In the event of a conflict between any term set forth in the main body of a Quote and these Terms, the terms set forth in the main body of the Quote shall prevail. All prior or contemporaneous written or oral agreements or negotiations with respect to the subject matter shall have no effect. These Terms may not be modified unless in writing and signed by an authorized representative of Seller.
- 22. **Compliance with Laws** Buyer agrees to comply with all applicable laws, regulations, and industry and professional standards, including those of the United States of America, and the country or countries in which Buyer may operate, including without limitation the U.S. Foreign Corrupt Practices Act ("FCPA"), the U.S. Anti-Kickback Act ("Anti-Kickback Act"), U.S. and E.U. export control and sanctions laws ("Export Laws"), the U.S. Food Drug and Cosmetic Act ("FDCA"), and the rules and regulations promulgated by the U.S. Food and Drug Administration ("FDA"), each as currently amended. Buyer agrees to indemnify, defend, and hold harmless Seller from the consequences of any violation of such laws, regulations and standards by Buyer, its employees or agents. Buyer acknowledges that it is familiar with all applicable provisions of the FCPA, the Anti-Kickback Act, Export Laws, the FDCA and the FDA and certifies that Buyer will adhere to the requirements thereof and not take any action that would make Seller violate such requirements. Buyer represents and agrees that Buyer will not make any payment or give anything of value, directly or indirectly, to any governmental official, foreign political party or official thereof, candidate for foreign political office, or commercial entity or person, for any improper purpose, including the purpose of influencing such person to purchase Products or otherwise benefit the business of Seller. Buyer further represents and agrees that it will not receive, use, service, transfer or ship any Product from Seller in a manner or for a purpose that violates Export Laws or would cause Seller to be in violation of Export Laws.

5/2017

A	Hose
B	Tubing
C	Coiled Air Hose & Fittings
D	Transportation
E	Fittings
F	Tooling, Equipment & Accessories
G	General Technical

Part Number Index pg. 1

Part Number	Page	Part Number	Page	Part Number	Page	Part Number	Page
015301	F-5, F-8, F13	10691N	E-52	16791N	E-56	1J791N	E-58
015302	F-8, F-9	10691NRD	E-53	16792	E-61	1J793N	E-63
015303	F-8, F-9	10693N	E-62	16991N	E-56	1J7CG	E-75
015304	F-8, F-9	10694	E-64	16992	E-61		
015305	F-8, F-9	10695	E-64			1J956	E-42
015306	F-6, F-8			17791N	E-56	1J991N	E-59
015307	F-6	106CG	E-73	17991N	E-57	1J993N	E-63
015308	F-6	106CY	E-78			1J9CG	E-75
015309	F-6	106SF	E-81	19256	E-43	1J9CY	E-79
015310	F-8, F-9			19291N	E-60		
015411	F-8, F-9	10756	E-36	1AL56	E-44	1JBSF	E-81
015412	F-8, F-9	10791N	E-53	1AL91N	E-57		
015413	F-8, F-9	107CG	E-74	1ALCG	E-74	1JC56	E-40
015414	F-8, F-9					1JC91N	E-59
015415	F-8, F-9	10856	E-37	1B156	E-44	1JC93N	E-63
015736	F-6	10891N	E-53	1B256	E-44	1JCCG	E-76
		108MS	E-80	1B291	E-60	1JCCY	E-78
025349	F-6, F-9			1C356	E-45	1JS56	E-41
025399	F-5, F-9, F13	10C56	E-43	1C456	E-45	1JSCG	E-76
025411	F-5	1120	D-5	1C556	E-45	1JSSF	E-81
				1C656	E-46	1L956	E-39
101-(PTFE)	B-44	11356	E-37	1C956	E-46	1L9CG	E-76
10156	E-34	113CY	E-78				
10191N	E-52	11C56	E-43	1CA56	E-47	1LMCY	E-79
10193N	E-62			1CE56	E-47		
101CG	E-72	12891N	E-54	1CF56	E-48	1P691N	E-57
101CY	E-77	12892	E-61			1PDCY	E-79
101SF	E-81			1D056	E-49		
101SQ	E-82	13491N	E-54	1D256	E-49	1TFMS	E-80
		134MS	E-80	1D956	E-49	1TU56	E-42
10256	E-34					1TU91N	E-59
102CG	E-73	13756	E-38	1FU56	E-48	1TUCG	E-76
102CY	E-77	13791N	E-54	1FUCG	E-75		
		13793N	E-62			1WU56	E-50
103-(FEP)	B-66	137CG	E-74	1GKCY	E-79	1WW56	E-50
10356	E-35			1GK91N	E-60	1WY56	E-50
1035HT	A-57	13956	E-38				
10391N	E-52	13991N	E-55	1HUSQ	E-82	201-(Metric PTFE)	B-44
103CG	E-73	13993N	E-63			20151	E-22
		139CG	E-74	1J056	E-40	20151R	E-24
104-(PFA)	B-77	139CY	E-78	1J0CG	E-75		
10456	E-35					20190	E-26
		13E56	E-37	1J156	E-40	201BU	E-31
105-(H.P. PFA)	B-79			1J191N	E-58		
10556	E-35	14156	E-39			203-(Metric FEP)	B-66
105CG	E-73	14191N	E-55	1J256	E-41	20351	E-22
10656	E-36	14956	E-39	1J556	E-41	20351R	E-24
		16191N	E-55	1J756	E-42		

Part Number Index pg. 2

Part Number	Page	Part Number	Page	Part Number	Page	Part Number	Page
204-(Metric PFA)	B-77	538DM	A-51			929BJ	A-73
				771164	D-9		
205-(Metric H.P. PFA)	B-79	540N	A-49			939/939B	A-74
		540P	A-50	8LPG	A-61		
20651	E-23					94C-080-PFD	F-4
20651R	E-25	55LT	A-52	811537	D-10	94C-001-PFD	F-4
20690	E-27			81914/1	B-65	94C-002-PFD	F-4
206BU	E-31	55SG	F-17	81914/2	B-65	94C-MKS	F-6
		55SSG	F-16	81914/3	B-74		
20851	E-23			81914/4	B-74	944B	A-75
20890	E-27	5PSG	F-16				
208MS	E-32			822011	F-8, F-9	95FR	B-39
		56DH	A-53	822012	F-8, F-9	955B	A-76
213BU	E-31			822031	F-8, F-9	95U	B-37
		560TJ	A-38			95UM	B-37
22890	E-27	563LT	A-40	82C-061L-PFD	F-10	95UM	B-37
		563TJ	A-39	82C-0AP-PFD	F-13	95UFS	C-7
23490	E-28			82C-CHD-PFD	F-10		
23790	E-28	575X	A-54	82C-KKB-PFD	F-10	9A	A-82
23951	E-23	575XN	A-54	82C-R01-PFD	F-10	9M	A-82
23990	E-28				F4; F-8-F-10; F15	9P	A-82
		580661-PFD	F-19	82C-R02-PFD	F-10		
24398-PFD	F-19	580N	A-55			A0	C-4
		588N	A-55	83C-080-PFD	F-12	AS-Y	F-17
2613	F-17			83C-081-PFD	F-12		
		590TJ	A-41	83C-0CB-PFD	F-12	B9	A-58
26190	E-29	594TJ	A-42	83C-R02-PFD	F-12		
26790	E-29			83C-R02H-PFD	F-12	CL	E-66
26990	E-29	5CNG	A-59	83C-S40-PFD	F-12	CNGG	F-14
		5CNG/5CNGLT	F-16	83C-S20-PFD	F-12	CNGRP	A-60
27790	E-30	6-2 CTX-S	F-9	83FR	A-56	CR	B-75
27990	E-30	6-6 CTX-S	F-8, F-9			CV	B-63; B-74
				85C-00L-PFD	F-10, F-11	CVL	B-63
2GK-Nut	E-60; E-79	68NTA	D-10	85C-0HP-PFD	F-13	CVH	B-63
2JS51R	E-25	685RA	E-50	85C-OEP-PFD	F-13		
2TFMS	E-32			85C-1PH-PFD	F-10, F-11	CY02-652317	E-79
		703	C-9	85C-CHD-PFD	F-11		
332T-115V-PFD	F-19	704	C-9	85C-KKB-PFD	F-11	D6R	A-32
3PSG	F-16	705	C-9	85C-R01-PFD	F-11, F-15	D6RX	A-32
3PSG-4	E-70			85C-R02-PFD	F-11		
		731512-Blue, Red	D-9	85C-STD-PFD	F-10, F-11	E	B-20
510C	A-43	731513-Blue, Red	D-9			E Male Cam & Groove	E-67
510D	A-44	731516	D-9	881540-PFD	F-19	EB	B-20
		731522	D-9				
518C	A-45	731612-Blue, Red	D-9	919/919B	A-69	FBS	E-67
518D	A-46			919BJ	A-70	FIL	E-68
520N	A-47	741526	D-9	919J	A-70	FJX	E-69
527BA	A-48	741590-Blue, Red	D-9	919U	A-71	FORFS	E-69
528N	A-47	751641	D-9	929/929B	A-72		
53DM	A-51						

A Hose

B Tubing

C Coiled Air Hose & Fittings

D Transportation

E Fittings

F Tooling, Equipment & Accessories

G General Technical

Part Number Index pg. 3

Part Number	Page	Part Number	Page	Part Number	Page	Part Number	Page
FP	E-68	MSXL	A-64	SAN	E-71		
FS	F-17	N	B-28-30	SC300	E-66		
GH9211	D-9	NA-6520	E-60; E-79	SCB	A-78		
GH9212	D-9	NB	B-28-30	SCBV	A-79		
H6	A-35	NBR	B-34	SCW	A-78		
HBR	F-16	NCB	A-81	SCWV	A-79		
HDPE	B-25	NCW	A-81	SFR	E-71		
HFSR	A-33	NN	B-28-30	SQ-101-SW	F-14		
HFS2R	A-34	NNR	B-34	SQ Mender	F-14		
HLB	A-62	NR	B-33	ST300	E-66		
HS1.25FEP	B-71	PAT	B-32	STB	A-77		
HS1.3FEP	B-69	PCB	A-80	STW	A-77		
HS1.6FEP	B-69	PCW	A-80	TFB	B-53		
HS2TFI	B-57	PC300	E-66	TFH, AWG	B-48		
HS2TFL, AWG	B-57	PEFR	B-24	TFL, AWG	B-51		
HS2TFL, Fractional	B-57	PF ANSI Flange	E-70	TFS, AWG	B-49		
HS2TFS, AWG	B-58	PF150	E-70	TFT, AWG	B-50		
HS2TFS, Fractional	B-57	PF154	E-70	TH11-1-PFD	F-19		
HS2TFT, AWG	B-59	PF156	E-70	TH9-1-XXX	F-15		
HS2TFT, Fractional	B-57	PFT	D-5	TSWTF	B-55		
HS4TFI	B-61	PLCF	E-70	TUBE	E-70		
HTB/HTBR	A-37	PP	B-36	VBL	F-15		
HTC	F-19	PPB	B-36	VBS	F-15		
HTFL	D-7	PSG	F-16; F-18				
MBS	E-67	PST	F-19				
MC	C-5	PTC	F-20				
MIL	E-68	PTC-001-RB	F-20				
ML	C-5	PTH	A-65				
MP	E-69	PV (guard)	F-16				
MSAN	E-71	PV (tubing)	B-41				
MSH	A-63	R6	A-36				
		S5N	A-66				
		S6	A-67				
		S9	A-68				

Tubing
B Thermoplastic

Coiled Air Hose
C & Fittings

D Transportation

F Fittings

Tooling,
Equipment
T & Accessories

General
Technical

Key Word Index pg. 1

Part	Page	Part	Page	Part	Page
1.25/1 Heat Shrink	B-71	Duramax™ (53DM)	A-51	NoMar® Fast-Stor® Coil Assy	C-7
1.3/1 Heat Shrink	B-69			Non-Conductive Hose 518D, 528N, 538DM, 588N	A-46: A-47, A-51, A-55
1.67/1 Heat Shrink	B-69	Elec. Conductive Compressed Nat. Gas Hose	A-59; A-60	Nylon Air Brake Tubing	D-5
2:1 Heat Shrink	B-56	Eliminator® (HTB/HTBR)	A-37	Nylon Tubing	B-27
4:1 Heat Shrink	B-61				
51 Series	E-22	Fast Response Hose (575x)	A-54	PAGE Fittings	E-65
51R Series	E-24	Fast-Stor® Air Hose	C-4	Parkrimp Dies	F-15
56 Series	E-33	Fast-Stor® Fittings	C-5	Parkrimp 2	F-12
90 Series	E-26	FEP Heat Shrink	B-69	Partek Sleeve	F-17
91N Series	E-51	FEP Tubing	B-66	PFA Tubing	B-77
92 Series	E-61	Field Attachable Fitting	E-22	polyflex Hose	A-84
93N Series	E-62	Fifth Wheel Slider	D-10	Polyethylene Tubing	B-22
94 Series	E-64			Polypropylene Tubing	B-35
95 Series	E-64	Fire Sleeve	F-17	Polyurethane Tubing	B-37
		Flange	E-70	Power Cleaning Hose	A-57
A-LOK® Fitting	E-57; E-70; E-74	Flange Retainer	E-71	Predator® (S5, S6, S9)	A66:A-68
Abrasion King® (R6)	A-36	Flare-Seal Hose	A-79	PTFE Beading	B-52
Adapter	E-50	Fluoropolymer Retractable Coils	C-8	PTFE Heat Shrink	B-56
Air Brake Tubing	D-5	Fluoropolymer Tubing	B-44	PTFE Hose	A-69
Air Hose	C-4			PTFE Spiral Wrap	B-56
AWG Tubing	B-47	Grease Zerk Fitting	E-60; E-79	PTFE Tubing	B-44
		Guards	F-18	Pumps (Crimpers)	F-13
Bend Restrictor	F-16	Harnesses	D-11	Pure Air Tubing	B-31
Brakcoil	D-9	Heat Shrink Tubing	B-56; B-69		
Breathing Air Hose	A-48	Heavy Wall PTFE Hose	A-72; A-79	Rapid Assy Fitting	E-50
BU Series	E-31	High Density Tubing	B-25	Replacement Parts (MiniKrimp)	F-8
Bulkhead Nut	E-60	High Purity Tubing	B-79	Roll Cover	B-71
Bundles	D-11	Hose Cutter	F-19	SCR Hose	D-12
		Hose Guard	F-16		
CG Series	E-56			Sewer Hose	A-66
Clear Vinyl Hose Guard	F-16	Insertion Block	F-15	SF Series	E-81
Clear Vinyl Tubing	B-41			Skive Tool	F-20
Collars	E-66	Karrykrimp	F-10	SQ Series	E-82
Convolute Hose	A-73 : A-79	Karrykrimp 2	F-11	Swager	F-14
Convolute Tubing	B-62; B-73				
Corrugated Tubing	B-75	Low Temperature Hose (55LT)	A-52	Table Mount	F-6
Crimp Fittings	E-33	Lubrication Line Hose (HLB)	A-62	TOUGHJACKET™ Hose	A-38: A-41
Crimpers/Crimping Machines	F-4			Tube Cutter	F-20
Cut-off Tools	F-19	Marine Hose (MSH)	A-63		
CY Series	E-62	Metal Hose	A-82	Vinyl Tubing	B-41
		Microweld	B-39	Vise Blocks	F-15
Diagnostic Hose	A-53	MiniKrimp	F-4		
Dies	F-15	Mounts	F-6		
Diesel Fuel Tubing	D-7	MS Series	E-65		
DuraGard™ (83FR)	A-56	Multitube® Bundles	A-83		

A
Hose

B
Tubing

C
Coiled Air Hose
& Fittings

D
Transportation

E
Fittings

F
Tooling,
Equipment
& Accessories

G
General
Technical

Key Word Index pg. 2

Part	Page	Part	Page
TECHNICAL DATA		TECHNICAL DATA	
AIR HOSE		TUBING	
Air Hose Durometer.....	C-3	Compatibility Chart for Fittings.....	B-8
FITTINGS		Fluoropolymer Chemical Resistance ...	B-5
British Standard Pipe	E-14	Material Property Overview.....	B-4
Fitting Configurations	E-5	Materials.....	B-10
Fitting Thread Guide for Hose	E-18	Material Compatibility Guide	B-11
German DIN Thread Types	E-13	Nomenclature	B-14
Hose Fitting Insertion Values	E-10	Pressure Ranges.....	B-7
Identifying Fitting Types	E-11	Specifications.....	B-6
Japanese Fittings	E-17		
Media to Fitting Compatibility	E-20		
Metals Corrosion Scale	E-21		
Nomenclature	E-4		
North American Thread Types.....	E-15		
Pressure Rating- End Connections ...	E-8		
Sanitary Sizing	E-6		
Thread Type (Determining)	E-12		
HOSE			
Agency Specifications	A-7		
Assembly & Crimping	G-3		
Calculation of Hose Length	A-19		
Compatibility Guide Media/Hose			
Material.....	A-22		
Construction/Specs, Thermoplastic Hose			
psi	A-10		
Construction/Specs, Thermoplastic Hose			
MPa	A-14		
Construction/Specs, PTFE Hose psi			
.....	A-12		
Construction/Specs, PTFE Hose psi MPa			
.....	A-16		
Hose Constructions	A-9		
Material Features	A-20		
Material Overview	A-21		
Nomenclature	A-29		
PTFE Hose Chemical Resistance	A-8		
Selection, Installation Maintenance ...	A-27		
Selection of Hose Diameter	A-18		
Swaged Assembly	G-15		
Stamped Form	A-19		
Twin/Multi-Line Hose Separation.....	G-17		
Volumetric Expansion of Hose.....	A-26		

A Hose

B Tubing Thermoplastic

C Coiled Air Hose & Fittings

D Transportation

M Fittings

T Tooling, Equipment & Accessories

General Technical

Parker Fluid Connectors Group

North American Divisions & Distribution Service Centers

Your complete source for quality tube fittings, hose & hose fittings, brass & composite fittings, quick-disconnect couplings, valves and assembly tools, locally available from a worldwide network of authorized distributors.

Fittings:

Available in inch and metric sizes covering SAE, BSP, DIN, GAZ, JIS and ISO thread configurations, manufactured from steel, stainless steel, brass, aluminum, nylon and thermoplastic.

Hose, Tubing and Bundles:

Available in a wide variety of sizes and materials including rubber, wire-reinforced, thermoplastic, hybrid and custom compounds.

Worldwide Availability:

Parker operates Fluid Connectors manufacturing locations and sales offices throughout North America, South America, Europe and Asia-Pacific.

For information, call toll free...

1-800-C-PARKER
(1-800-272-7537)

North American Divisions

Fluid System Connectors Division

Otsego, MI
phone 269 694 9411
fax 269 694 4614

Hose Products Division

Wickliffe, OH
phone 440 943 5700
fax 440 943 3129

Parflex Division

Ravenna, OH
phone 330 296 2871
fax 330 296 8433

Quick Coupling Division

Minneapolis, MN
phone 763 544 7781
fax 763 544 3418

Tube Fittings Division

Columbus, OH
phone 614 279 7070
fax 614 279 7685

Distribution Service Centers

Buena Park, CA

phone 714 522 8840
fax 714 994 1183

Conyers, GA

phone 770 929 0330
fax 770 929 0230

Louisville, KY

phone 502 937 1322
fax 502 937 4180

Portland, OR

phone 503 283 1020
fax 503 283 2201

Toledo, OH

phone 419 878 7000
fax 419 878 7001
fax 419 878 7420
(FCG Kit Operations)

Canada

Milton, ONT

phone 905-693-3000
fax 905-876-1958
(Contact Milton for other Service Center locations.)

Mexico

Toluca, MEX

phone (52) 722 2754 200
fax (52) 722 2722 168

